



FAG

added
competence



Super Precision Bearings

SCHAEFFLER GROUP
INDUSTRIAL

Super Precision Bearings

Every care has been taken to ensure the correctness of the information contained in this publication but no liability can be accepted for any errors or omissions.

We reserve the right to make technical changes.

© Schaeffler KG · 2008, April

This publication or parts thereof may not be reproduced without our permission.

AC 41 130/7 EA

added
competence



added competence for your success

With trend-setting bearing arrangement solutions for in-feed spindles, main spindles, rotary tables and linear guidance units, the Schaeffler Group and its brands INA and FAG have been at the forefront of the world market for decades.

FAG Super Precision Bearings for main spindles represent both the highest precision and absolute operational reliability. Innovative FAG spindle bearing solutions continually raise the standards for speed, precision and service life. However, the bearing components alone no longer guarantee the success of the main spindle system and the overall machine. Significant performance increases and unique selling points for customers are now achieved when the bearing manufacturer consults and develops based on extensive system knowledge, and provides system services. The potential that leads to market leadership lies in close partnerships with the manufacturers of spindles and machine tools and in the shared experience and knowledge of the needs of the end users and their customers.

The experience gathered by the Schaeffler Group for more than a century in application engineering, consulting and production engineering forms one of the largest product portfolios worldwide. This knowledge is always part of the solution we provide our customers. Conversely, the Schaeffler Group also benefits from its close involvement in applied solutions and from close contact with its partners. Schaeffler Sector Management Production Machinery terms as “added competence” this approach based on cooperation in a partnership, with the aim of achieving consistently “Faster, More Precise, Longer-Lived and More Economical” service in subsystems and overall systems.

The integration of important functions such as sealing, lubrication, location, damping and anti-corrosion protection and more results in fewer interfaces and lower maintenance requirements, increased operational reliability and time advantages in the market place, in addition to cost savings. Basic research, calculation programs, installation assistance, fitting aids and training courses available through a closely knit network of sales and production sites also increase the value benefit for the customer.

The prompt, reliable presence of Schaeffler employees guarantees that our most valuable asset, namely our personal connection, is available to you, our partners.

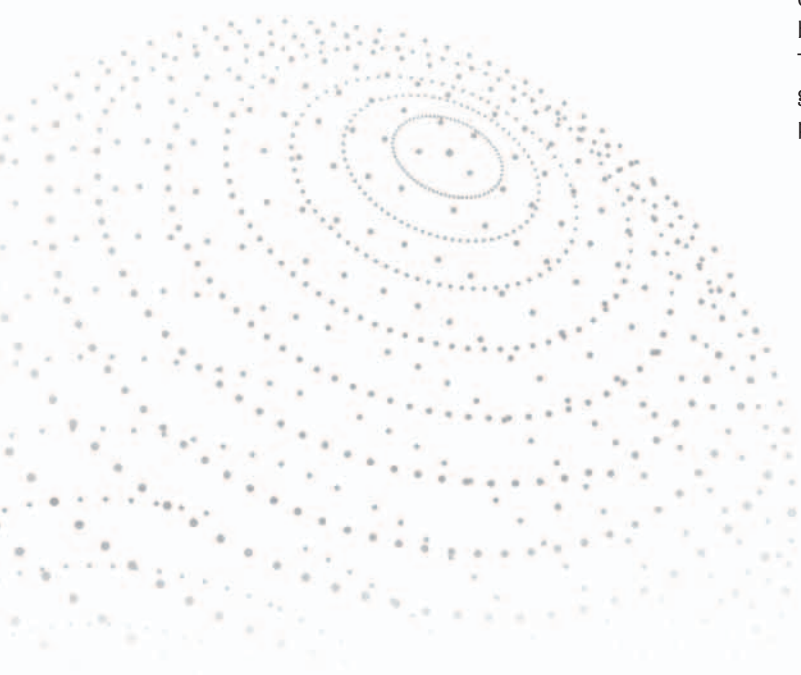

Contents

Added competence for the main spindle – optimum benefit for the customer!	Page 6
FAG Spindle Bearings	Page 10
FAG Floating Displacement Bearings	Page 88
FAG Super Precision Cylindrical Roller Bearings	Page 96
FAG Double Direction Angular Contact Thrust Ball Bearings	Page 124
Tolerances	Page 138
Tolerances for Super Precision Bearings	Page 138
Corner dimensions	Page 162
Machining Tolerances for Mating Parts	Page 164
Engineering	Page 176
Lubrication	Page 176
Service Life of Super Precision Bearings	Page 184
Speed dependent fits	Page 187
Speeds	Page 189
Deflection and Rigidity	Page 190
Bearing Monitoring	Page 192
Bearing arrangement design and application examples	Page 194
Bearing arrangement design	Page 194
Application examples	Page 199
Request to calculate bearing arrangement	Page 203
Mounting guidelines	Page 204
Handling of Super Precision Bearings	Page 204
Checklist for spindle mounting	Page 208
Template for spindle checklist	Page 209
Clearance Adjustment in Cylindrical Roller Bearings	Page 210
F'IS Mounting service	Page 212
Customised Solutions	Page 218
Appendix	Page 226
BEARINX®	Page 226
Request to calculate bearing	Page 227
Checklist for spindle mounting	Page 228
Template for spindle checklist	Page 229
Overview card of grease quantities and distribution action	Page 230
Further products	Page 231
Addresses	Page 233
Index	Page 238
Notes	Page 240

**Added competence for the main spindle –
Optimum benefit for the customer!**

Page 6

FAG Spindle Bearings

Page 10

B719..C, B70..C, B72..C, HS70..C, HS719..C, B718..C

B719..E, B70..E, B72..E, HS70..E, HS719..E, B718..E

Page 20

FAG Floating Displacement Bearings

Page 88

FD10

Page 92

FAG Super Precision Cylindrical Roller Bearings

Page 96

N10, N19, HCN10

Page 102

NN30, NNU49

Page 116

FAG Double Direction Angular Contact Thrust Ball Bearings

Page 124

2344, 2347

Page 130

Tolerances

Page 138

Engineering

Page 176

Bearing arrangement design and application examples

Page 194

Mounting guidelines

Page 204

Customised Solutions

Page 218

Appendix

Page 226

Added competence for the main spindle – Optimum benefit for the customer!

“Optimum benefit for the customer” is the aim of the Sector Management Production Machinery within the Schaeffler Group Industrial. For main spindle bearings, this demand applies to far more than simply manufacturing a good product, as it also takes into account the application, the end user and his requirements. This leads to the following requirement for all divisions that deal with the manufacturing of FAG Super Precision Bearings:

- Top quality and technology leadership
- Closest proximity to the customer
- Highest cost-effectiveness for the specific application.



Highest precision and cleanliness in production ...



... in bearing assembly



... in spindle mounting

FAG solutions and its customers

The beginning and end of all our company activities are the same: proximity and benefit for the customer. Exact knowledge of the specific application requirements and processes is decisive in selecting the technologically optimum product that also correlates to the lowest system costs. This can derive from the sophisticated FAG range of Spindle Bearings, which possesses depth and breadth unmatched worldwide. The solution can also be custom-made and application-specific, provided both promptly and reliably by the Schaeffler Group.



... in work result

On components and expertise

FAG Super Precision Bearings set standards wherever there are extreme demands in terms of reliability, high running accuracy and high speeds – whether incorporated in machine tools, in the textile industry, woodworking machines or elsewhere. The comprehensive product range permits optimum bearing arrangements for all types of locations and applications.

Schaeffler Group's research facilities and close contact with the customer provide the fundamentals for continuously developing existing products and expanding the product range.

FAG Super Precision Bearings always combine the technical solution of a bearing application with the economic solution. This becomes apparent when the bearing system is analyzed holistically in terms of calculations, simulation and design, as well as distribution, mounting and service. The analysis begins with the principal demands made of the bearings, but also includes examination of options for application-appropriate integration of important functions such as sealing, lubrication, location, monitoring, etc.

The interactions of bearing arrangement adjustments on the system as a whole can already be tested at this stage. Schaeffler Group Industrial provides proven calculation and simulation tools for independent use or as a service, and offers comprehensive training and consultation events.



Milling spindle in use

This catalog gives a detailed overview of the FAG product range of high precision bearing arrangements as well as the most important rules for bearing selection, bearing arrangement design and mounting. For more detailed information, please do not hesitate to contact our competent partners.

About this catalog

This catalog (FAG AC 41 130/7) presents the product range of FAG Super Precision Bearings for main spindles. It is further designed as a technical compendium for the selection and design of bearing arrangements utilizing high precision bearings. The principal engineering-related information for the designer is summarized and accessible. The clear structure, numerous cross-references and the subject index at the end make it easier for students and “young colleagues” in training to enter the world of high precision bearing arrangements. For the experienced user of spindle bearings, it provides a ready presentation of all components, expertise and services offered by the Schaeffler Group.

The catalog is provided in 8 languages (German, English, French, Italian, Spanish, Czech, Chinese and Japanese) and is available in all languages on a CD-ROM of the same name. It is also available on the Internet for download at www.fag.com and www.schaeffler.com. The printed catalog can be requested (in limited quantities) for free through your national company (see appendix, Page 233 ff.).

Catalog structure

The catalog is divided into six parts. Following the introduction, the chapter “Bearing tables” lists the complete product range of Super Precision Bearings. The important technical characteristics and performance features are described in tabular form. This section is structured based on the different bearing types: Spindle, Cylindrical Roller, Floating Displacement and Double Direction Angular Contact Thrust Ball Bearings.

A short introduction to the bearing forms, design types and a description of nomenclature is provided at the beginning of the bearing tables. The “Tolerances” chapter follows the table section and contains information about the bearings and their mating parts.

In the following “Engineering” chapter, the necessary steps and calculation methods for selecting and designing a spindle bearing arrangement are presented. The calculation of service life, lubrication life, limited speed and rigidity are given particular attention. The necessary methodological steps for concrete application engineering design of a spindle are presented in the “Bearing arrangement design” chapter. The mounting of spindle bearings requires special attention regarding procedure, accessories and environmental conditions that must be maintained. These are addressed in detail in the “Mounting guidelines” chapter. In addition to the “Standard range,” the Schaeffler Group offers customer-specific bearing solutions in the high precision sector. Options are described in the “Customised Solutions” chapter.



Product features of FAG Super Precision Bearings

FAG accuracy to P4S · The right material · Lubrication

FAG accuracy to P4S

At first glance, the accuracy of bearings seems to be sufficiently defined in DIN/ISO or ABEC standards. Yet FAG Super Precision Bearings go beyond this. In addition to demanding tolerances to P4 or better, there are other performance features that are not covered by these norms. All important product features of FAG Super Precision Bearings meet Precision Class P2. This applies to the running accuracy as well as the parallelism of FAG bearings that are manufactured to FAG standard P4S. Maximum precision bearing arrangements can therefore be designed with standard FAG Super Precision Bearings. (see tolerances for Single Row FAG Spindle Bearings, Pages 144 ff.)

The right material

FAG Super Precision Bearings are manufactured from high grade materials. High material fatigue life and wear resistance have been achieved using a specific heat treatment, so that the bearings can in many cases be operated with infinite service life. The material Cronidur 30 is particularly important, as it makes a Spindle Bearing into an X-life ultra Bearing. Its unique properties as to fatigue strength and corrosion resistance result in significantly extended service life, higher admissible contact pressure for infinite service life, higher admissible speeds and significantly enhanced lubricant service life. For Spindle Bearings, Hybrid Bearings, i.e. bearings in combination with steel rings and ceramic balls, are

now standard. Ceramic rollers are also used in Cylindrical Roller Bearings. Silicon nitride is the ceramic material that combines the typical ceramic properties in the most favorable way. They offer many advantages over steel rolling elements, such as

- outstanding tribological behavior in combination of steel and ceramics. The stress on material and lubricants is significantly reduced in hybrid bearings.
- a lower density that reduces centrifugal forces on the rolling elements, improving the bearing's kinematics
- lower coefficient of thermal expansion of the ceramic rolling elements. It has a positive effect on the change in bearing preload in the event of temperature differences during operation.

These factors result in significantly extended bearing life. For this reason, hybrid bearings are now frequently used even at lower speeds.

Lubrication

The grease used plays an important role in the overall bearing system. The decision as to grease or oil lubrication has a significant effect on the system costs. The goal of Schaeffler Group is to permit and advance grease lubrication even at maximum speeds. Before a lubricant is approved for bearings, it undergoes a strict approval process. The calculations and suitability tests for the application-specific requirements, for example the temperature behavior and run-in behavior of a spindle running at high speed, are very important



FAG Super Precision Bearings

parts of the process. The result of this extensive process is an approved product specification for the lubricant in question, whose precise compliance is ensured by continuous inspection.

FAG Spindle Bearings



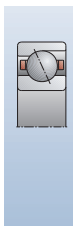

FAG Spindle Bearings are single row angular contact ball bearings of the highest precision. The outer envelope dimensions are standardised, so they can be interchanged with other market sector products. The FAG range of Super Precision Bearings for main spindles in machine tools is among the most sophisticated in the world and represents the highest-performance technology. FAG Spindle Bearings are available in almost all designs developed for the main spindle market. The selection can therefore accommodate almost all application-specific demands. Their special design features in terms of contact geometry, material selection, surface quality and lubricant guidance stand for:

- highest precision
- excellent speed-ability
- high rigidity and
- good vibration behavior.

For new machine tools it is possible to deliver significant performance increases and cost saving potentials. These can be realised when expertise in bearing system arrangements and identification of the most suitable bearing type are considered and optimised; equally correct bearing mounting practices must be employed.

FAG Spindle Bearing solutions can give new designs unique selling points in the market, similarly existing designs can be upgraded and achieve enhanced performance. The tables here in this catalog show the actual product range of FAG Spindle Bearings. However, the listing is not final in terms of dimensions and design types; Spindle Bearings can be offered in additional sizes and variants upon request.

FAG Universal Bearings

FAG Universal Bearings are a speciality. They are manufactured in such a way that they can be mounted in any arrangement without suffering performance losses, and can be combined in different sets. This brings essential logistical advantages, especially in spare parts purchasing and stock-keeping. The bearings can be arranged according to the symbol on the outer ring surface.

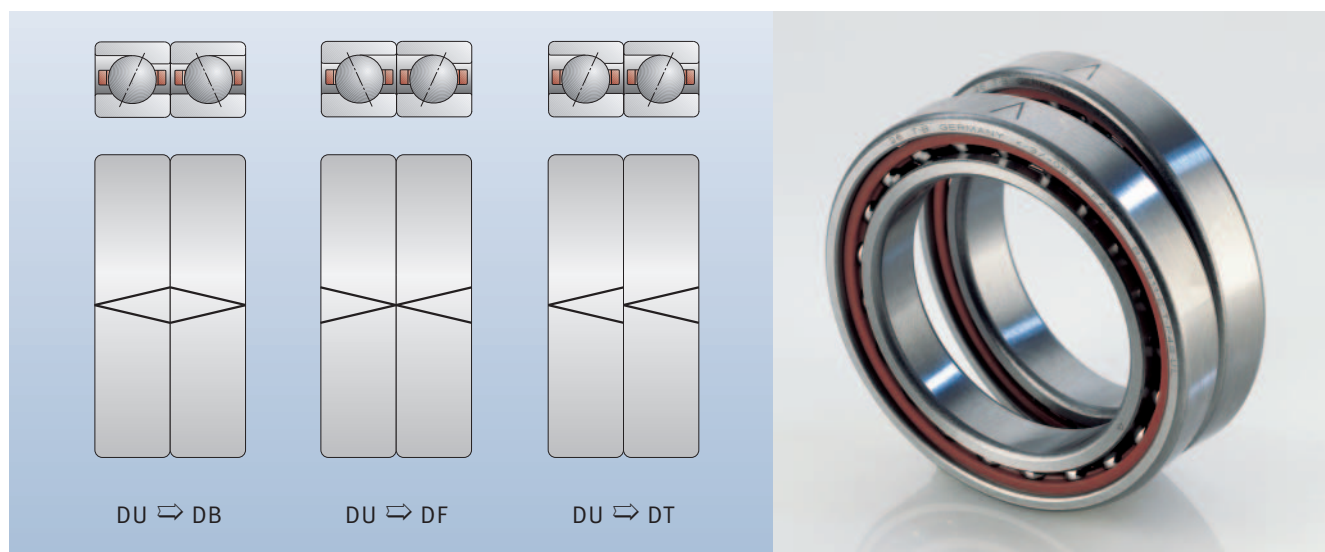

1: Installation possibilities of a DU set

FAG Spindle Bearings

Sealed Spindle Bearings

Sealed Spindle Bearings

Spindle bearings are high precision functional parts that react sensitively to damaging influences from the environment such as contamination and airflows. Proper greasing in terms of the amount and selection of lubricant is also a criterion that can directly affect machine service life, as the grease service life is in effect equal to the bearing service life. Early on, FAG set the standard for High Speed Spindle Bearings (HSS, HCS and XCS) with sealed bearings. Almost all spindle bearings are now offered with non-contact gap seals on both sides, as their special sealing advantages have gained acceptance on the market. Sealed FAG Spindle Bearings are filled with FAG ARCANOL L075 high performance grease and combine many advantages:

- robust, compact unit
- ready-to-fit, lubricated for-life, maintenance-free
- factory-filled with optimum grease in the appropriate quantity
- protected against contamination and airflow

The wide range of applications for Sealed Spindle Bearings also marks the continuing trend from oil lubrication to grease lubrication. High Speed versions of FAG Sealed Spindle Bearings bear the abbreviation S (for Sealed) in their classification. Large-ball bearings, such as bearings of the B prefix, carry the designation 2RSD in their name.

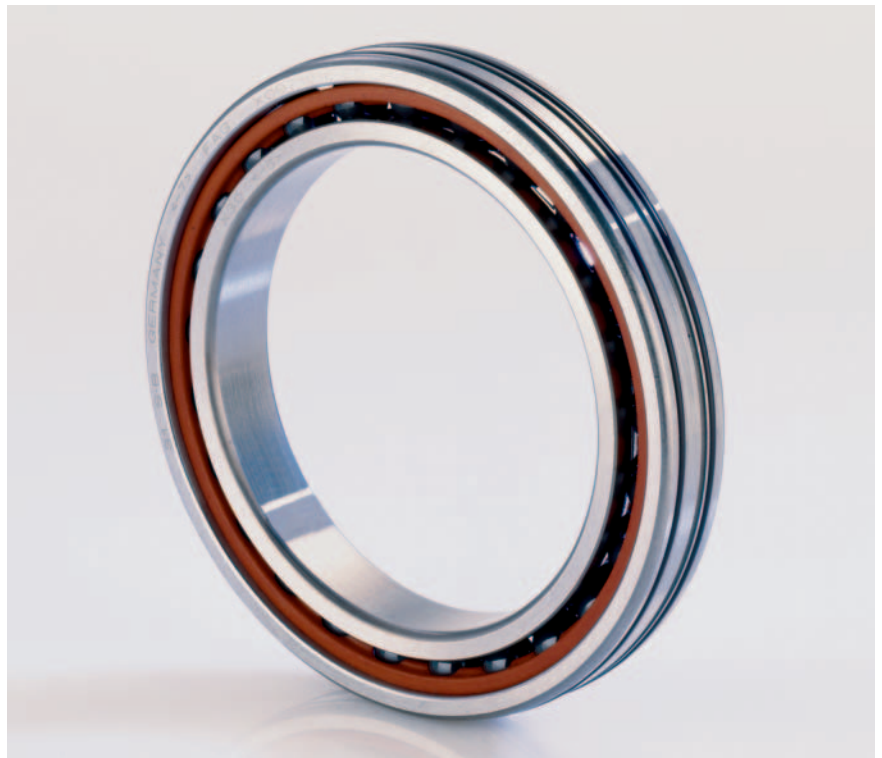

2: Direct Lube Bearings



3: Sealed Spindle Bearings

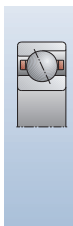

FAG Spindle Bearings

FAG Direct Lube Bearings · Hybrid Bearings

Direct Lube Bearings

Where grease lubrication meets its limits, FAG Direct Lube (DLR) Bearings ideally complement the Spindle Bearing range. Direct Lube Bearings ensure reliable lubricant feed very close to the point of rolling contact. This is achieved by a circumferential groove and radial supply holes. Integral precision O-rings seal the bearing against the spindle housing. FAG DLR Bearings reach extremely high speeds. The exceptional power density of this bearing design is not its only advantage. The design allows for the elimination of costly elements in the surrounding structure. The result is savings in both space and cost.

Hybrid Bearings

The market demands for Spindle Bearings with rings made of steel and balls of ceramic material are increasing. Originally found only in the high speed sector, hybrid bearings are now also being used at significantly lower speeds.

The reasons lie in:

- their robustness and reliability
- their significantly extended grease service life

The material pairing of steel and ceramic exerts significantly lower loads on the lubricant in comparison with the pairing of steel and steel. The pressure ellipses are smaller, therefore there is less strain on the lubricant.

Due to the different materials the opportunity for adhesion is also lower. Similarly the thermal load is reduced in comparison to all steel bearings.

By using hybrid bearings significant speed increases can be achieved, this has allowed the extension of grease lubrication into a new range of applications.

The resulting system cost savings, both design and operational, can be substantial.



4: Hybrid Spindle Bearings

FAG Spindle Bearings

X-life ultra Bearings



5: FAG X-life ultra Spindle Bearings

X-life ultra Bearings

X-life ultra Bearings were designed for maximum demands on speed-ability and load. They are Hybrid Bearings with rings made of Cronidur 30, a high nitrogen stainless steel. Compared to the conventional rolling bearing steel 100Cr6, Cronidur 30 exhibits a substantially finer structure, thus ensuring cooler operation and higher admissible contact pressure.

Tests of the material fatigue life exceeded the calculated values by such a large degree that it can be considered practically fail-safe in the field of application. Under mixed friction conditions, this steel also lasted up to 10 times longer than the standard material 100Cr6. This steel is likewise significantly superior to conventional rolling bearing steels in terms of Hertzian compression strength, corrosion resistance and hot hardness.

Compared to conventional bearings, the extended service life of X-life ultra Bearings makes an enormous contribution to reducing system costs. In principle, all Spindle Bearing designs are available as X-life ultra Bearings. To take full advantage of the performance capability of X-life ultra Bearings, the structure surrounding the bearing arrangement must be designed appropriately.



FAG Spindle Bearings

Spindle Bearings of the TX Generation

Spindle Bearings of the TX Generation

In addition to the selection of materials and lubricants to be used, lubricant amount and delivery is relevant for reducing friction in the bearings, particularly in the high speed sector. This is evidenced by the huge temperature reductions achieved with the Spindle Bearings of the new FAG TX Generation. Their new internal design is based on the knowledge that the contact point of the cage becomes much more important as speeds increase. Modified cage design and lubricant flow allow the FAG TX Spindle Bearings to run up to 10% cooler even in the high speed range. At the same time, this new generation of bearings opens up potential for speed increases of up to 10% at the same boundary conditions. The operational reliability of the bearings has increased accordingly, while the machine downtimes and system costs are reduced. The advantages of the new cage design are so convincing that FAG has introduced the TX design into the product range as a selectable Spindle Bearing specification.

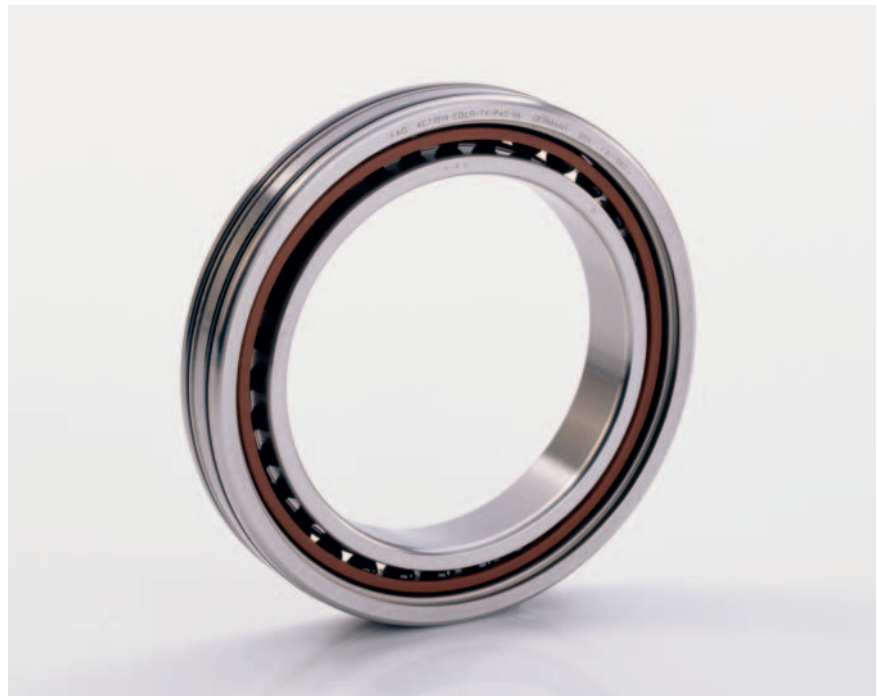

6: Direct Lube Spindle Bearings with TX Cage



7: Design of T Cage



8: Design of TX Cage

FAG Spindle Bearings

Spindle Bearing Code

Spindle bearing code

All FAG Super Precision Bearings for machine tool spindles bear a uniform code. In addition to the bearing identification, the markings on the bearing also contain important information about:

- Tolerance of inner ring bore and outside diameter
- Bearing width and
- Mounting orientation, through direction of the marking on outer ring surface

This information supports the installation engineer for an accurate matching of bearings and shaft or housing. This ensures that the performance potential in the bearings is maximised, in addition this coding information can be useful for economic stock keeping. Details on the bearing code can be found in the nomenclature (Spindle Bearings) on the following double page.

Contact angle marks on a single bearing

The position of the contact angle is marked by an arrow on the bearing outer circumference. The open side of the arrow faces the outer ring lip end.

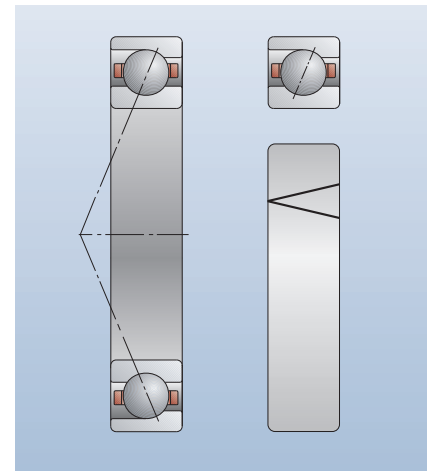

9: Direction of thrust through the contact angle marks on a single bearing

FAG Spindle Bearings

Spindle Bearing Code

Designation and marking of bearing sets

Bearing sets consist of bearings with matched bore and outside diameters. The first letter refers to the number of bearings in a set.
 D 2 bearings – Duplex
 T 3 bearings – Triplex
 Q 4 bearings – Quadroplex
 Ready-to-mount bearing sets feature a defined order of bearings. The second (and sometimes third) letter refers to the arrangement of the bearings within the set:

- B back-to-back arrangement
- F face-to-face arrangement
- T tandem arrangement
- BT back-to-back arrangement against a tandem set of 2 or 3 bearings
- FT face-to-face arrangement against a tandem set of 2 or 3 bearings

The mounting position for ready-to-fit bearings is indicated by an additional arrow across the entire set, the bearings should be arranged to re-create the arrow.

The second letter in the set designation of universal bearing sets is U. The bearings in universal bearing sets can be mounted in any arrangement without suffering performance loss. Universal bearing sets therefore do not feature mounting position marks at the circumference, except for their direction of thrust marks.

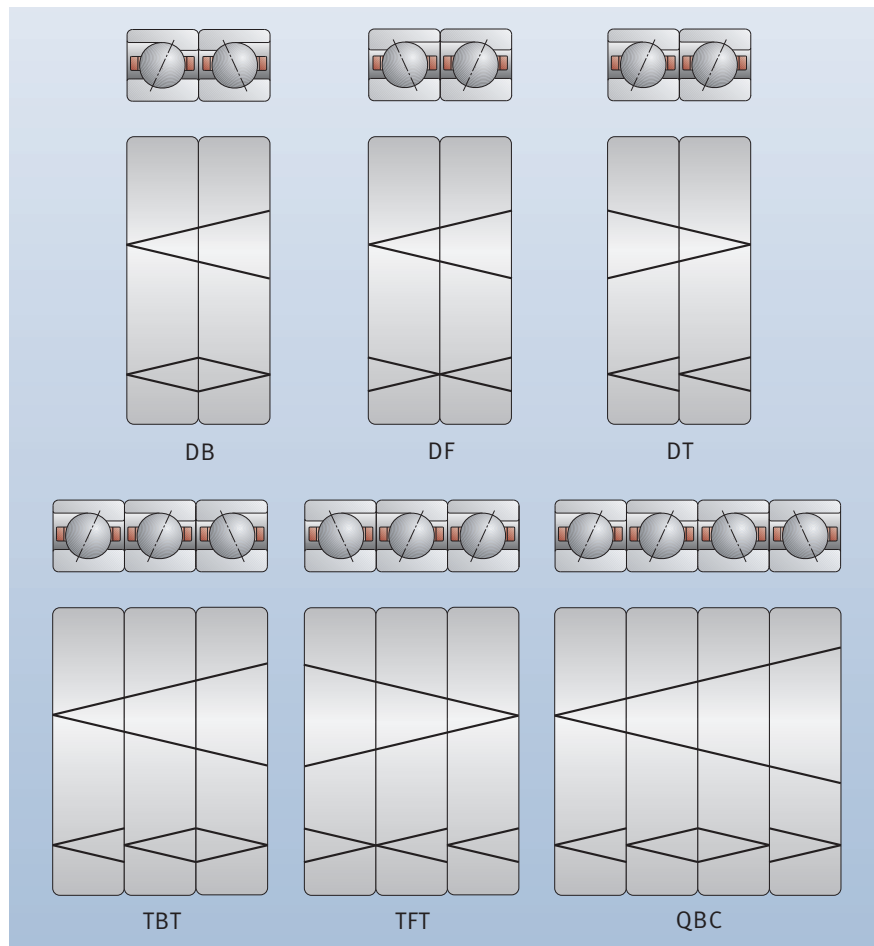

10: Examples of ready-to-mount bearing sets

Bearing Code of FAG Spindle Bearings

B 70 08-C **-T-P4S-UL***
HSS 70 08-C **-T-P4S-UL**
HCB 70 08-C **DLR** **-T-P4S-UL**
B 70 08-C-2RSD **-T-P4S-UL**
B 70 08-C **-T-P4S-UL-L075**

Bearing Type

B	Standard Steel balls
HCB	Hybrid Standard Ceramic balls
XCB	Cronidur Standard Ceramic balls
HS	High Speed Bearings Steel balls
HSS	High Speed Bearings Steel balls, sealed
HC	High Speed Bearings Ceramic balls
HCS	High Speed Bearings Ceramic balls, sealed
XC	Cronidur, High Speed Bearings Ceramic balls
XCS	Cronidur, High Speed Bearings Ceramic balls, sealed

Dimension Series

718	Ultra-light series
719	Light series
70	Medium series
72	Heavy series

Bore Reference Number

6	6 mm
7	7 mm
8	8 mm
9	9 mm
00	10 mm
01	12 mm
02	15 mm
03	17 mm
04	4 · 5 = 20 mm
05	5 · 5 = 25 mm

Contact Angle

C	15°
E	25°

External Form

	DIRECT LUBE	
-CDLR	Direct radial lubrication holes with integral O rings	15°
-EDLR	Integral O-ring	25°

Seal

-2RSD	Sealed at both sides and lubricated Sealed designs are indicated with a point (•) in the bearing tables
--------------	---

Grease Filling By Manufacturer

L075 FAG Grease Arcanol L075 for non-sealed bearings. Bearings sealed at both sides are lubricated for-life with L075.

Preload

L	Light
M	Medium
H	Heavy

Bearing Arrangement

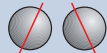
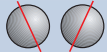
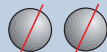
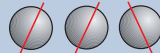
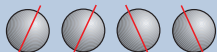
U	Single bearing arrangeable as desired
DU	Set of 2 universal bearings
TU	Set of 3 universal bearings
QU	Set of 4 universal bearings
PU	Set of 5 universal bearings
DB	Set of 2 bearings O arrangement 
DF	Set of 2 bearings X arrangement 
DT	Set of 2 bearings Tandem arrangement 
TBT	Set of 3 bearings Tandem – O – arrangement 
QBC	Set of 4 bearings Tandem – O – Tandem arrangement. 

Accuracy

P4S	FAG Standard better than P4 according to DIN 620
P4S-K5	P4S but with mean sorting of bore and outside diameter

Cage

T	Textile laminated phenolic resin, outer ring guided
TX	Textile laminated phenolic resin, outer ring guided
TPA	Textile laminated phenolic resin, series B718 outer ring guided

* Special designs are available by agreement. You can find more information in the “Customized Solutions” chapter.

Bearing Marking of FAG Spindle Bearings



FAG Spindle Bearings in unsealed design

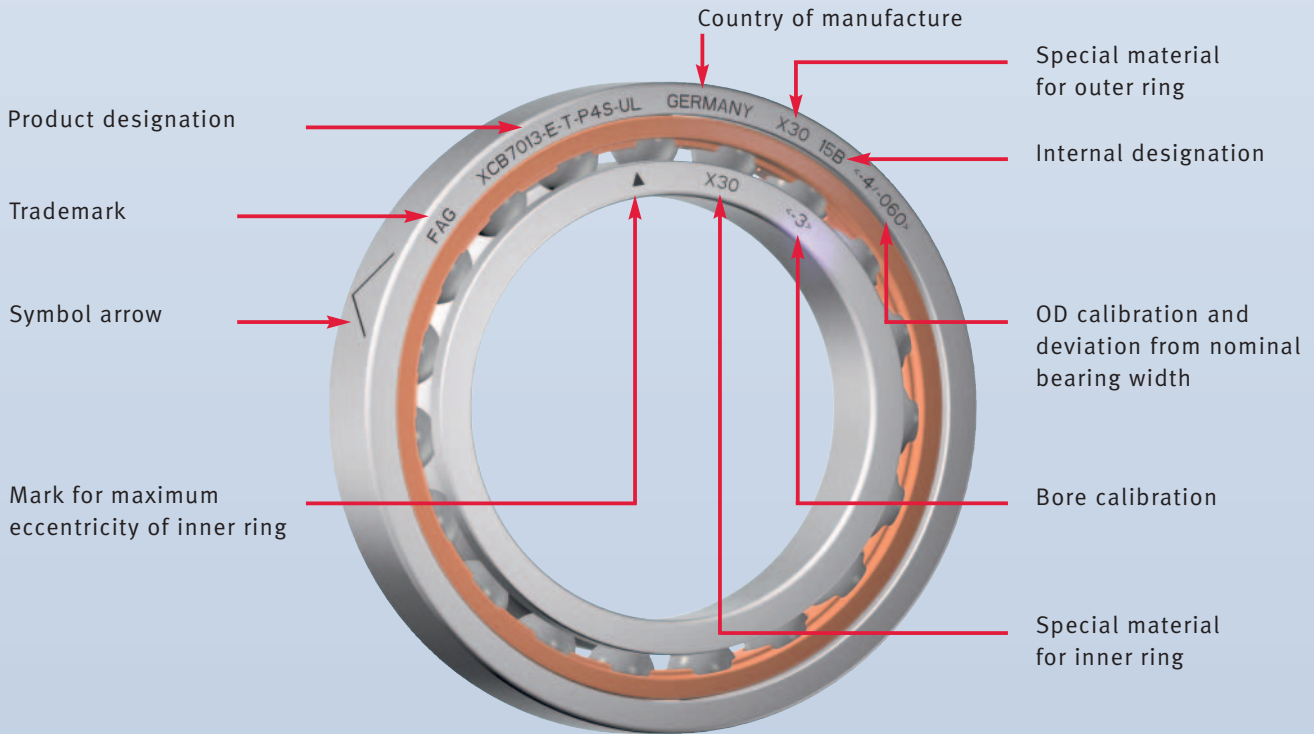

FAG Spindle Bearings in sealed design

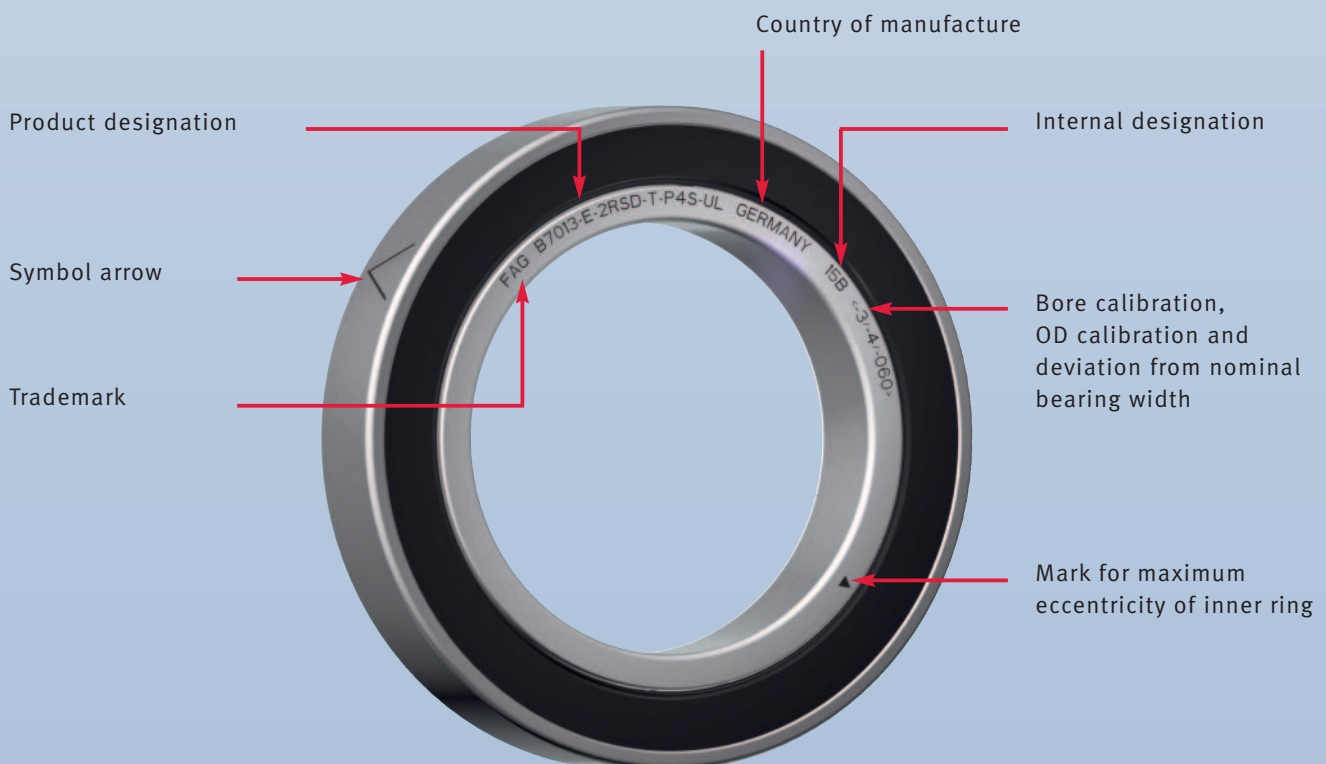

B718..C/E, B719, B70, B72 HS719..C/E, HS70

C: Contact angle $\alpha = 15^\circ$
E: Contact angle $\alpha = 25^\circ$

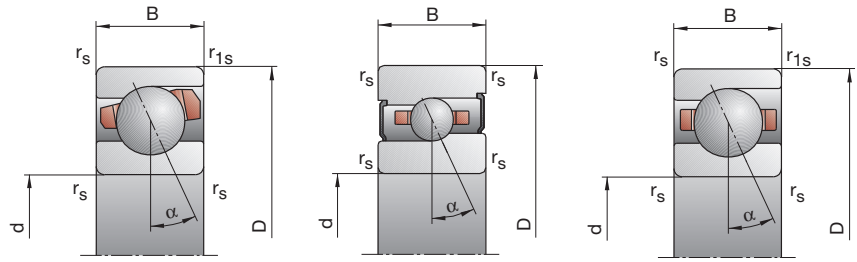

Attainable speed**		Preloading force F_V			Unloading force*** K_{aE}			Axial rigidity*** c_a			Sealed design*	Weight	Bearing code
Grease	Oil	L	M	H	L	M	H	L	M	H		kg	FAG
min ⁻¹	minimal	N						N/μm					
95 000	160 000	9	34	77	28	119	294	8,6	16,4	25,5	—	0,005	B706-CT-P4S
85 000	140 000	14	60	132	42	187	429	20,9	36,5	51,4	—	0,005	B706-ET-P4S
120 000	190 000	5	17	39	15	56	138	7,5	13,0	19,5	—	0,004	HCB706-CT-P4S
100 000	170 000	5	28	67	15	85	211	16,5	30,3	43,0	—	0,004	HCB706-E-T-P4S
160 000	260 000	5	17	39	15	56	138	7,5	13,0	19,5	—	0,004	XCB706-CT-P4S
130 000	200 000	5	28	67	15	85	211	16,5	30,3	43,0	—	0,004	XCB706-E-T-P4S
120 000	190 000	5	16	31	15	52	108	6,2	10,5	14,7	•	0,010	HS706-CT-P4S
100 000	170 000	8	25	51	23	75	157	15,3	23,8	31,6	•	0,010	HS706-E-T-P4S
140 000	220 000	4	11	21	12	35	70	6,4	9,9	13,3	•	0,010	HC706-CT-P4S
130 000	190 000	6	18	35	18	54	107	16,2	23,7	30,6	•	0,010	HC706-E-T-P4S
180 000	300 000	4	11	21	12	35	70	6,4	9,9	13,3	•	0,010	XC706-CT-P4S
160 000	260 000	6	18	35	18	54	107	16,2	23,7	30,6	•	0,010	XC706-E-T-P4S
85 000	140 000	9	38	85	28	133	324	9,3	18,4	28,4	—	0,008	B707-CT-P4S
75 000	120 000	16	65	145	47	202	470	23,2	40,4	57,1	—	0,008	B707-ET-P4S
110 000	180 000	5	18	43	15	59	152	8,1	14,2	21,7	—	0,007	HCB707-CT-P4S
95 000	160 000	5	30	73	15	91	228	17,8	33,5	47,5	—	0,007	HCB707-E-T-P4S
150 000	240 000	5	18	43	15	59	152	8,1	14,2	21,7	—	0,007	XCB707-CT-P4S
120 000	190 000	5	30	73	15	91	228	17,8	33,5	47,5	—	0,007	XCB707-E-T-P4S
110 000	180 000	6	17	34	18	55	118	7,1	11,4	16,2	•	0,010	HS707-CT-P4S
90 000	150 000	9	27	54	26	81	166	17,2	26,1	34,4	•	0,010	HS707-E-T-P4S
120 000	190 000	4	12	23	12	38	77	6,9	10,9	14,8	•	0,010	HC707-CT-P4S
120 000	180 000	6	19	37	18	57	112	17,4	25,9	33,1	•	0,010	HC707-E-T-P4S
160 000	260 000	4	12	23	12	38	77	6,9	10,9	14,8	•	0,010	XC707-CT-P4S
140 000	220 000	6	19	37	18	57	112	17,4	25,9	33,1	•	0,010	XC707-E-T-P4S

B718..C/E, B719, B70, B72 HS719..C/E, HS70

C: Contact angle $\alpha = 15^\circ$
E: Contact angle $\alpha = 25^\circ$

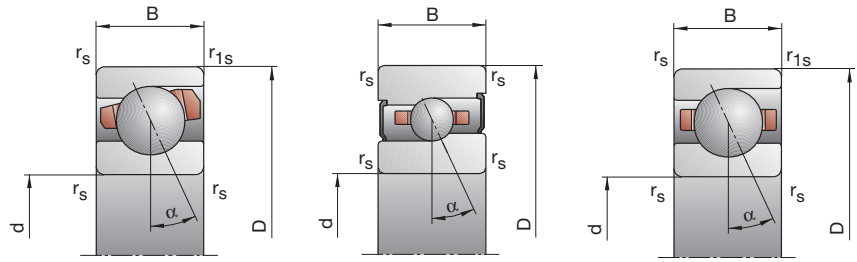

Attainable speed**		Preloading force F_V			Unloading force*** K_{aE}			Axial rigidity*** c_a			Sealed design*	Weight	Bearing code
Grease	Oil	L	M	H	L	M	H	L	M	H		kg	FAG
min ⁻¹	minimal	N						N/μm					
75 000	120 000	15	59	129	47	206	490	12,0	22,9	34,9	—	0,010	B708-CT-P4S
67 000	100 000	19	90	207	56	277	668	26,4	47,9	68,6	—	0,010	B708-ET-P4S
95 000	160 000	6	29	66	18	95	232	9,2	18,0	26,8	—	0,009	HCB708-CT-P4S
80 000	130 000	10	39	100	29	118	312	23,4	39,1	56,5	—	0,009	HCB708-ET-P4S
120 000	190 000	6	29	66	18	95	232	9,2	18,0	26,8	—	0,009	XCB708-CT-P4S
100 000	170 000	10	39	100	29	118	312	23,4	39,1	56,5	—	0,009	XCB708-ET-P4S
95 000	160 000	6	19	38	18	62	131	8,0	13,4	18,7	•	0,010	HS708-CT-P4S
80 000	130 000	10	30	61	29	89	187	20,1	30,2	40,3	•	0,010	HS708-ET-P4S
110 000	180 000	4	13	26	12	41	87	7,7	12,5	17,3	•	0,010	HC708-CT-P4S
95 000	150 000	7	21	42	20	62	127	19,7	29,7	38,9	•	0,010	HC708-ET-P4S
140 000	220 000	4	13	26	12	41	87	7,7	12,5	17,3	•	0,010	XC708-CT-P4S
120 000	190 000	7	21	42	20	62	127	19,7	29,7	38,9	•	0,010	XC708-ET-P4S
67 000	100 000	23	85	181	72	293	676	14,4	26,5	39,6	—	0,015	B709-CT-P4S
60 000	90 000	31	131	292	91	401	930	32,4	56,3	79,0	—	0,015	B709-ET-P4S
85 000	140 000	8	39	90	24	127	311	10,6	20,5	30,2	—	0,013	HCB709-CT-P4S
75 000	120 000	15	56	137	44	168	423	28,3	45,7	64,6	—	0,013	HCB709-ET-P4S
110 000	180 000	8	39	90	24	127	311	10,6	20,5	30,2	—	0,013	XCB709-CT-P4S
100 000	170 000	15	56	137	44	168	423	28,3	45,7	64,6	—	0,013	XCB709-ET-P4S
90 000	140 000	9	26	53	27	84	181	10,2	16,3	22,9	•	0,020	HS709-CT-P4S
75 000	120 000	14	43	86	41	128	262	25,2	37,9	49,8	•	0,020	HS709-ET-P4S
100 000	170 000	6	18	36	18	57	119	9,8	15,5	21,1	•	0,020	HC709-CT-P4S
85 000	140 000	10	30	59	29	89	179	25,0	37,3	48,5	•	0,020	HC709-ET-P4S
130 000	200 000	6	18	36	18	57	119	9,8	15,5	21,1	•	0,020	XC709-CT-P4S
110 000	180 000	10	30	59	29	89	179	25,0	37,3	48,5	•	0,020	XC709-ET-P4S

FAG Spindle Bearings

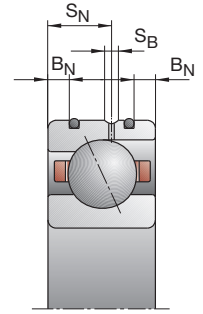
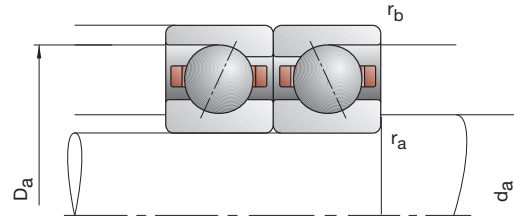
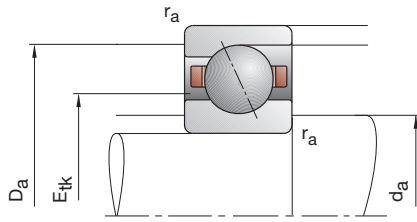

Bearing code	Dimensions					Abutment dimensions				DLR dimensions			Load rating			
	d	D	B	r _{smin}	r _{1smin}	d _a	D _a	r _a	r _b	B _N	S _N	S _B	E _{tk} nom.	C _{dyn}	C _{0stat}	
FAG	mm														kN	
B71800-C-TPA-P4	10	19	5	0,30	0,10	12	17	0,3	0,1				13,3	1,90	0,98	
B71800-E-TPA-P4	10	19	5	0,30	0,10	12	17	0,3	0,1				13,3	1,80	0,93	
HCB71800-C-TPA-P4	10	19	5	0,30	0,10	12	17	0,3	0,1				13,3	1,29	0,98	
HCB71800-E-TPA-P4	10	19	5	0,30	0,10	12	17	0,3	0,1				13,3	1,25	0,65	
B71900-C-T-P4S	10	22	6	0,30	0,30	13	19,5	0,3	0,3				15,2	3,00	1,53	
B71900-E-T-P4S	10	22	6	0,30	0,30	13	19,5	0,3	0,3				15,2	2,90	1,46	
HCB71900-C-T-P4S	10	22	6	0,30	0,30	13	19,5	0,3	0,3				15,2	2,08	1,06	
HCB71900-E-T-P4S	10	22	6	0,30	0,30	13	19,5	0,3	0,3				15,2	2,00	1,00	
XCB71900-C-T-P4S	10	22	6	0,30	0,30	13	19,5	0,3	0,3				15,2	4,65	1,06	
XCB71900-E-T-P4S	10	22	6	0,30	0,30	13	19,5	0,3	0,3				15,2	4,50	1,00	
HS71900-C-T-P4S	10	22	6	0,30		13	19,5	0,3	0,3				15,0	1,96	1,10	
HS71900-E-T-P4S	10	22	6	0,30		13	19,5	0,3	0,3				15,0	1,86	1,04	
HC71900-C-T-P4S	10	22	6	0,30		13	19,5	0,3	0,3				15,0	1,37	0,77	
HC71900-E-T-P4S	10	22	6	0,30		13	19,5	0,3	0,3				15,0	1,29	0,72	
XC71900-C-T-P4S	10	22	6	0,30		13	19,5	0,3	0,3				15,0	3,05	0,77	
XC71900-E-T-P4S	10	22	6	0,30		13	19,5	0,3	0,3				15,0	2,90	0,72	
B7000-C-T-P4S	10	26	8	0,30	0,30	14	22	0,3	0,1				16,4	4,25	2,08	
B7000-E-T-P4S	10	26	8	0,30	0,30	14	22	0,3	0,1				16,4	4,05	2,00	
HCB7000-C-T-P4S	10	26	8	0,30	0,30	14	22	0,3	0,1				16,4	2,90	1,43	
HCB7000-E-T-P4S	10	26	8	0,30	0,30	14	22	0,3	0,1				16,4	2,80	1,40	
XCB7000-C-T-P4S	10	26	8	0,30	0,30	14	22	0,3	0,1				16,4	6,40	1,43	
XCB7000-E-T-P4S	10	26	8	0,30	0,30	14	22	0,3	0,1				16,4	6,30	1,40	
HS7000-C-T-P4S	10	26	8	0,30		14	22	0,3	0,1				16,8	2,75	1,60	
HS7000-E-T-P4S	10	26	8	0,30		14	22	0,3	0,1				16,8	2,60	1,50	
HC7000-C-T-P4S	10	26	8	0,30		14	22	0,3	0,1				16,8	1,90	1,10	
HC7000-E-T-P4S	10	26	8	0,30		14	22	0,3	0,1				16,8	1,80	1,06	
XC7000-C-T-P4S	10	26	8	0,30		14	22	0,3	0,1				16,8	4,30	1,10	
XC7000-E-T-P4S	10	26	8	0,30		14	22	0,3	0,1				16,8	4,00	1,06	
B7200-C-T-P4S	10	30	9	0,60	0,60	14,5	25,5	0,6	0,6				18,8	5,85	2,90	
B7200-E-T-P4S	10	30	9	0,60	0,60	14,5	25,5	0,6	0,6				18,8	5,60	2,80	
HCB7200-C-T-P4S	10	30	9	0,60	0,60	14,5	25,5	0,6	0,6				18,8	4,00	2,04	
HCB7200-E-T-P4S	10	30	9	0,60	0,60	14,5	25,5	0,6	0,6				18,8	3,90	1,96	

- * options; • = possible, – = not possible
- ** see section Engineering, Speeds
- *** see section Engineering, Deflection and Rigidity

Designation examples:

Sealed design

B7000-C-2RSD-T-P4S-UL
HSS7000-E-T-P4S-UL

Hybrid ceramic design

HC7000-E-T-P4S-UL
HCB71800-C-TPA-P4-UL

X-life ultra design

XCB7000-E-2RSD-T-P4S-UL
XC7000-E-T-P4S-UL

B718..C/E, B719, B70, B72 HS719..C/E, HS70

C: Contact angle $\alpha = 15^\circ$
E: Contact angle $\alpha = 25^\circ$

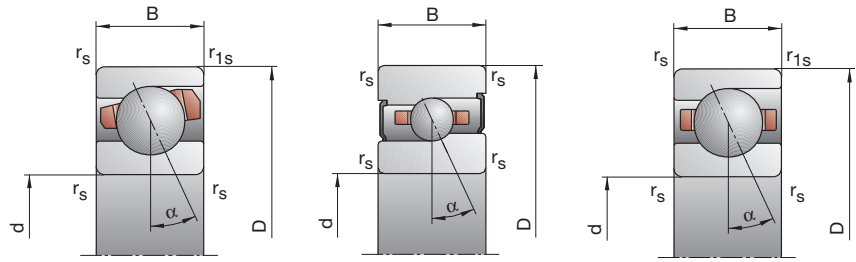

Attainable speed**		Preloading force			Unloading force***			Axial rigidity***			Sealed design*	Weight	Bearing code
Grease	Oil	L	M	H	L	M	H	L	M	H			
min ⁻¹	minimal	N						N/μm			kg	FAG	
75 000	120 000	7	23	54	21	76	194	9,3	16,2	25,4	—	0,005	B71800-C-TPA-P4
70 000	110 000	8	31	80	23	91	246	20,1	33,1	49,2	—	0,005	B71800-E-TPA-P4
95 000	160 000	4	13	33	12	41	112	8,5	13,8	21,5	—	0,005	HCB71800-C-TPA-P4
85 000	140 000	6	21	48	17	62	145	20,2	32,5	44,6	—	0,005	HCB71800-E-TPA-P4
70 000	110 000	14	51	114	44	179	438	12,6	23,5	36,6	•	0,009	B71900-C-T-P4S
63 000	95 000	17	63	149	50	193	476	27,0	44,8	64,5	•	0,009	B71900-E-T-P4S
90 000	150 000	5	20	49	15	65	171	9,2	16,7	25,5	•	0,008	HCB71900-C-T-P4S
75 000	120 000	9	25	70	27	75	217	24,9	35,4	52,7	•	0,008	HCB71900-E-T-P4S
110 000	180 000	5	20	49	15	65	171	9,2	16,7	25,5	•	0,008	XCB71900-C-T-P4S
100 000	170 000	9	25	70	27	75	217	24,9	35,4	52,7	•	0,008	XCB71900-E-T-P4S
90 000	150 000	7	20	39	21	65	134	8,9	14,3	19,8	•	0,010	HS71900-C-T-P4S
75 000	120 000	11	32	64	32	95	195	22,0	32,6	42,9	•	0,010	HS71900-E-T-P4S
100 000	170 000	5	14	27	15	44	90	8,8	13,5	18,4	•	0,010	HC71900-C-T-P4S
90 000	140 000	7	22	44	20	65	133	20,8	31,9	41,6	•	0,010	HC71900-E-T-P4S
130 000	200 000	5	14	27	15	44	90	8,8	13,5	18,4	•	0,010	XC71900-C-T-P4S
110 000	180 000	7	22	44	20	65	133	20,8	31,9	41,6	•	0,010	XC71900-E-T-P4S
60 000	90 000	17	67	145	53	227	531	12,6	23,3	34,9	•	0,02	B7000-C-T-P4S
56 000	85 000	22	100	224	64	303	706	27,9	49,6	69,4	•	0,02	B7000-E-T-P4S
80 000	130 000	7	32	73	21	103	249	9,9	18,4	27,0	•	0,02	HCB7000-C-T-P4S
67 000	100 000	11	43	110	32	128	337	24,8	40,4	58,1	•	0,02	HCB7000-E-T-P4S
100 000	170 000	7	32	73	21	103	249	9,9	18,4	27,0	•	0,02	XCB7000-C-T-P4S
85 000	140 000	11	43	110	32	128	337	24,8	40,4	58,1	•	0,02	XCB7000-E-T-P4S
80 000	130 000	9	27	55	27	87	187	10,7	17,3	24,2	•	0,02	HS7000-C-T-P4S
67 000	100 000	15	44	89	44	131	271	27,2	40,1	52,9	•	0,02	HS7000-E-T-P4S
90 000	150 000	6	19	38	18	60	125	10,3	16,5	22,5	•	0,02	HC7000-C-T-P4S
80 000	120 000	10	31	62	29	92	188	26,3	39,7	51,7	•	0,02	HC7000-E-T-P4S
120 000	190 000	6	19	38	18	60	125	10,3	16,5	22,5	•	0,02	XC7000-C-T-P4S
100 000	170 000	10	31	62	29	92	188	26,3	39,7	51,7	•	0,02	XC7000-E-T-P4S
56 000	85 000	25	92	198	77	313	730	16,2	29,9	44,9	•	0,03	B7200-C-T-P4S
50 000	75 000	31	139	312	89	419	980	35,0	62,5	88,2	•	0,03	B7200-E-T-P4S
70 000	110 000	13	57	126	39	186	441	13,9	26,2	38,8	•	0,03	HCB7200-C-T-P4S
60 000	90 000	22	81	194	64	241	597	35,4	56,9	80,7	•	0,03	HCB7200-E-T-P4S

FAG Spindle Bearings

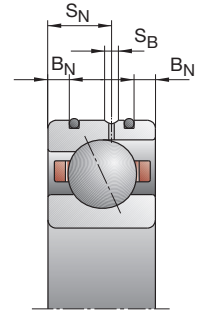
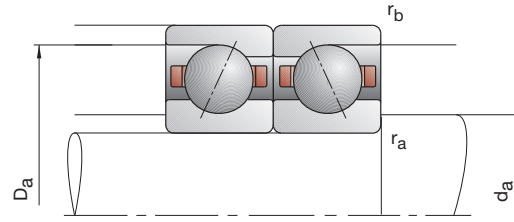
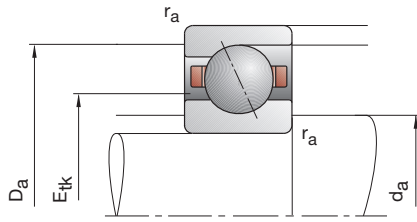

Bearing code	Dimensions						Abutment dimensions				DLR dimensions			Load rating	
	d	D	B	r _{smin}	r _{1smin}	d _a	D _a	r _a	r _b	B _N	S _N	S _B	E _{tk} nom.	C _{dyn}	C _{0stat}
FAG	mm														
B71801-C-TPA-P4	12	21	5	0,30	0,10	14	19	0,3	0,1				15,3	2,08	1,18
B71801-E-TPA-P4	12	21	5	0,30	0,10	14	19	0,3	0,1				15,3	1,96	1,12
HCB71801-C-TPA-P4	12	21	5	0,30	0,10	14	19	0,3	0,1				15,3	1,43	0,83
HCB71801-E-TPA-P4	12	21	5	0,30	0,10	14	19	0,3	0,1				15,3	1,34	0,78
B71901-C-T-P4S	12	24	6	0,30	0,30	15	21,5	0,3	0,3				17,2	3,35	1,86
B71901-E-T-P4S	12	24	6	0,30	0,30	15	21,5	0,3	0,3				17,2	3,20	1,76
HCB71901-C-T-P4S	12	24	6	0,30	0,30	15	21,5	0,3	0,3				17,2	2,32	1,29
HCB71901-E-T-P4S	12	24	6	0,30	0,30	15	21,5	0,3	0,3				17,2	2,20	1,22
XCB71901-C-T-P4S	12	24	6	0,30	0,30	15	21,5	0,3	0,3				17,2	5,20	1,29
XCB71901-E-T-P4S	12	24	6	0,30	0,30	15	21,5	0,3	0,3				17,2	5,00	1,22
HS71901-C-T-P4S	12	24	6	0,30		15	21,5	0,3	0,3				17,0	2,04	1,20
HS71901-E-T-P4S	12	24	6	0,30		15	21,5	0,3	0,3				17,0	1,93	1,14
HC71901-C-T-P4S	12	24	6	0,30		15	21,5	0,3	0,3				17,0	1,40	0,83
HC71901-E-T-P4S	12	24	6	0,30		15	21,5	0,3	0,3				17,0	1,34	0,80
XC71901-C-T-P4S	12	24	6	0,30		15	21,5	0,3	0,3				17,0	3,15	0,83
XC71901-E-T-P4S	12	24	6	0,30		15	21,5	0,3	0,3				17,0	3,00	0,80
B7001-C-T-P4S	12	28	8	0,30	0,30	16,5	24,5	0,3	0,1				18,6	4,75	2,60
B7001-E-T-P4S	12	28	8	0,30	0,30	16,5	24,5	0,3	0,1				18,6	4,55	2,50
HCB7001-C-T-P4S	12	28	8	0,30	0,30	16,5	24,5	0,3	0,1				18,6	3,25	1,80
HCB7001-E-T-P4S	12	28	8	0,30	0,30	16,5	24,5	0,3	0,1				18,6	3,15	1,73
XCB7001-C-T-P4S	12	28	8	0,30	0,30	16,5	24,5	0,3	0,1				18,6	7,20	1,73
XCB7001-E-T-P4S	12	28	8	0,30	0,30	16,5	24,5	0,3	0,1				18,6	7,10	1,73
HS7001-C-T-P4S	12	28	8	0,30		16,5	24,5	0,3	0,1				18,8	2,70	1,63
HS7001-E-T-P4S	12	28	8	0,30		16,5	24,5	0,3	0,1				18,8	2,55	1,53
HC7001-C-T-P4S	12	28	8	0,30		16,5	24,5	0,3	0,1				18,8	1,86	1,12
HC7001-E-T-P4S	12	28	8	0,30		16,5	24,5	0,3	0,1				18,8	1,76	1,08
XC7001-C-T-P4S	12	28	8	0,30		16,5	24,5	0,3	0,1				18,8	4,15	1,12
XC7001-E-T-P4S	12	28	8	0,30		16,5	24,5	0,3	0,1				18,8	3,90	1,08
B7201-C-T-P4S	12	32	10	0,60	0,60	16,5	27,5	0,6	0,6				21,1	7,65	3,90
B7201-E-T-P4S	12	32	10	0,60	0,60	16,5	27,5	0,6	0,6				21,1	7,35	3,75
HCB7201-C-T-P4S	12	32	10	0,60	0,60	16,5	27,5	0,6	0,6				21,1	5,30	2,70
HCB7201-E-T-P4S	12	32	10	0,60	0,60	16,5	27,5	0,6	0,6				21,1	5,10	2,60

- * options; • = possible, – = not possible
- ** see section Engineering, Speeds
- *** see section Engineering, Deflection and Rigidity

Designation examples:

Sealed design

B7001-C-2RSD-T-P4S-UL
HSS7001-E-T-P4S-UL

Hybrid ceramic design

HC7001-E-T-P4S-UL
HCB71801-C-TPA-P4-UL

X-life ultra design

XCB7001-E-2RSD-T-P4S-UL
XC7001-E-T-P4S-UL

B718..C/E, B719, B70, B72 HS719..C/E, HS70

C: Contact angle $\alpha = 15^\circ$
E: Contact angle $\alpha = 25^\circ$

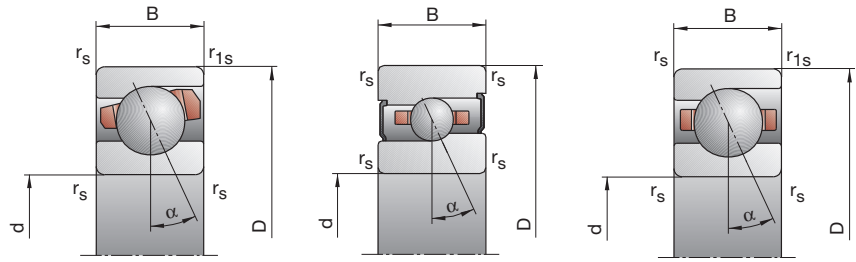

Attainable speed**		Preloading force F_V			Unloading force*** K_{aE}			Axial rigidity*** c_a			Sealed design*	Weight	Bearing code
Grease	Oil	L	M	H	L	M	H	L	M	H		kg	FAG
min ⁻¹		N						N/μm					
67 000	100 000	7	25	58	21	82	207	10,2	18,3	28,3	—	0,01	B71801-C-TPA-P4
60 000	90 000	8	33	85	23	97	260	22,3	37,4	55,1	—	0,01	B71801-E-TPA-P4
85 000	140 000	4	13	35	12	41	118	9,4	15,2	23,9	—	0,01	HCB71801-C-TPA-P4
75 000	120 000	7	22	51	20	64	153	23,7	35,9	50,0	—	0,01	HCB71801-E-TPA-P4
60 000	90 000	15	56	126	47	195	479	14,3	26,8	41,5	•	0,01	B71901-C-T-P4S
56 000	85 000	19	67	162	56	204	515	31,4	50,7	73,5	•	0,01	B71901-E-T-P4S
80 000	130 000	6	22	54	18	71	187	11,0	19,0	29,1	•	0,01	HCB71901-C-T-P4S
67 000	100 000	10	26	75	29	78	231	27,9	40,0	59,8	•	0,01	HCB71901-E-T-P4S
100 000	170 000	6	22	54	18	71	187	11,0	19,0	29,1	•	0,01	XCB71901-C-T-P4S
85 000	140 000	10	26	75	29	78	231	27,9	40,0	59,8	•	0,01	XCB71901-E-T-P4S
80 000	130 000	7	21	41	21	68	140	9,3	15,2	21,0	•	0,01	HS71901-C-T-P4S
67 000	100 000	11	33	66	32	98	201	23,1	34,5	45,4	•	0,01	HS71901-E-T-P4S
90 000	150 000	5	14	28	15	44	93	9,3	14,1	19,4	•	0,01	HC71901-C-T-P4S
85 000	130 000	8	23	46	23	68	139	23,0	34,0	44,4	•	0,01	HC71901-E-T-P4S
120 000	190 000	5	14	28	15	44	93	9,3	14,1	19,4	•	0,01	XC71901-C-T-P4S
100 000	170 000	8	23	46	23	68	139	23,0	34,0	44,4	•	0,01	XC71901-E-T-P4S
56 000	85 000	19	74	161	58	249	584	14,5	26,9	40,1	•	0,02	B7001-C-T-P4S
50 000	75 000	23	110	250	67	332	784	32,0	57,4	80,6	•	0,02	B7001-E-T-P4S
70 000	110 000	9	44	99	27	141	339	13,1	25,2	37,3	•	0,02	HCB7001-C-T-P4S
60 000	90 000	15	58	147	43	170	445	32,8	53,6	77,2	•	0,02	HCB7001-E-T-P4S
90 000	150 000	9	44	99	27	141	339	13,1	25,2	37,3	•	0,02	XCB7001-C-T-P4S
75 000	120 000	15	58	147	43	170	445	32,8	53,6	77,2	•	0,02	XCB7001-E-T-P4S
70 000	110 000	9	27	54	27	87	184	10,7	17,3	24,1	•	0,02	HS7001-C-T-P4S
60 000	90 000	15	44	87	44	131	264	27,2	40,2	52,3	•	0,02	HS7001-E-T-P4S
80 000	130 000	6	19	38	18	60	125	10,3	16,5	22,5	•	0,02	HC7001-C-T-P4S
75 000	110 000	10	30	61	29	89	184	26,3	39,2	51,2	•	0,02	HC7001-E-T-P4S
100 000	170 000	6	19	38	18	60	125	10,3	16,5	22,5	•	0,02	XC7001-C-T-P4S
90 000	150 000	10	30	61	29	89	184	26,3	39,2	51,2	•	0,02	XC7001-E-T-P4S
50 000	75 000	35	124	264	108	422	971	19,1	34,7	51,8	•	0,04	B7201-C-T-P4S
45 000	67 000	47	191	420	136	576	1 319	42,7	73,3	102,4	•	0,04	B7201-E-T-P4S
63 000	95 000	19	78	170	57	254	593	16,6	30,6	45,0	•	0,03	HCB7201-C-T-P4S
56 000	85 000	32	113	263	93	337	809	42,2	67,2	94,0	•	0,03	HCB7201-E-T-P4S

FAG Spindle Bearings

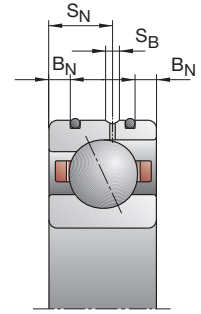
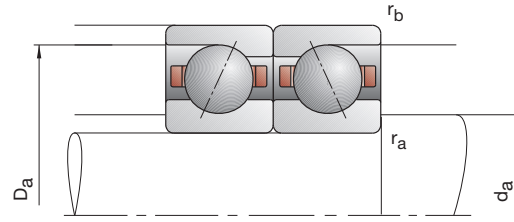
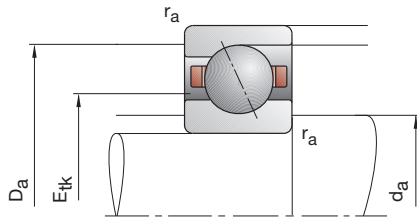

Bearing code	Dimensions					Abutment dimensions				DLR dimensions			Load rating			
	d	D	B	r _{smin}	r _{1smin}	d _a	D _a	r _a	r _b	B _N	S _N	S _B	E _{tk} nom.	C _{dyn}	C _{0stat}	
FAG	mm														kN	
B71802-C-TPA-P4	15	24	5	0,30	0,10	17	22	0,3	0,1				18,3	2,28	1,50	
B71802-E-TPA-P4	15	24	5	0,30	0,10	17	22	0,3	0,1				18,3	2,16	1,40	
HCB71802-C-TPA-P4	15	24	5	0,30	0,10	17	22	0,3	0,1				18,3	1,60	1,04	
HCB71802-E-TPA-P4	15	24	5	0,30	0,10	17	22	0,3	0,1				18,3	1,50	0,98	
B71902-C-T-P4S	15	28	7	0,30	0,30	18	25,5	0,3	0,3				20,9	5,00	2,90	
B71902-E-T-P4S	15	28	7	0,30	0,30	18	25,5	0,3	0,3				20,9	4,80	2,75	
HCB71902-C-T-P4S	15	28	7	0,30	0,30	18	25,5	0,3	0,3				20,9	3,45	2,00	
HCB71902-E-T-P4S	15	28	7	0,30	0,30	18	25,5	0,3	0,3				20,9	3,35	1,93	
XCB71902-C-T-P4S	15	28	7	0,30	0,30	18	25,5	0,3	0,3				20,9	6,70	2,00	
XCB71902-E-T-P4S	15	28	7	0,30	0,30	18	25,5	0,3	0,3				20,9	7,50	1,93	
HS71902-C-T-P4S	15	28	7	0,30		18	25,5	0,3	0,3				20,3	2,80	1,76	
HS71902-E-T-P4S	15	28	7	0,30		18	25,5	0,3	0,3				20,3	2,65	1,66	
HC71902-C-T-P4S	15	28	7	0,30		18	25,5	0,3	0,3				20,3	1,93	1,22	
HC71902-E-T-P4S	15	28	7	0,30		18	25,5	0,3	0,3				20,3	1,83	1,16	
XC71902-C-T-P4S	15	28	7	0,30		18	25,5	0,3	0,3				20,3	4,30	1,22	
XC71902-E-T-P4S	15	28	7	0,30		18	25,5	0,3	0,3				20,3	4,05	1,16	
B7002-C-T-P4S	15	32	9	0,30	0,30	19	29	0,3	0,1				22,3	6,20	3,40	
B7002-E-T-P4S	15	32	9	0,30	0,30	19	29	0,3	0,1				22,3	6,00	3,25	
HCB7002-C-T-P4S	15	32	9	0,30	0,30	19	29	0,3	0,1				22,3	4,30	2,36	
HCB7002-E-T-P4S	15	32	9	0,30	0,30	19	29	0,3	0,1				22,3	4,15	2,24	
XCB7002-C-T-P4S	15	32	9	0,30	0,30	19	29	0,3	0,1				22,3	9,65	2,36	
XCB7002-E-T-P4S	15	32	9	0,30	0,30	19	29	0,3	0,1				22,3	9,30	2,24	
HS7002-C-T-P4S	15	32	9	0,30		19	29	0,3	0,1				22,2	3,75	2,45	
HS7002-E-T-P4S	15	32	9	0,30		19	29	0,3	0,1				22,2	3,55	2,32	
HC7002-C-T-P4S	15	32	9	0,30		19	29	0,3	0,1				22,2	2,60	1,70	
HC7002-E-T-P4S	15	32	9	0,30		19	29	0,3	0,1				22,2	2,45	1,60	
XC7002-C-T-P4S	15	32	9	0,30		19	29	0,3	0,1				22,2	5,85	1,70	
XC7002-E-T-P4S	15	32	9	0,30		19	29	0,3	0,1				22,2	5,50	1,60	
B7202-C-T-P4S	15	35	11	0,60	0,60	19,5	30,5	0,6	0,6				23,3	9,65	5,00	
B7202-E-T-P4S	15	35	11	0,60	0,60	19,5	30,5	0,6	0,6				23,3	9,30	4,80	
HCB7202-C-T-P4S	15	35	11	0,60	0,60	19,5	30,5	0,6	0,6				23,3	6,70	3,45	
HCB7202-E-T-P4S	15	35	11	0,60	0,60	19,5	30,5	0,6	0,6				23,3	6,40	3,35	

- * options; • = possible, – = not possible
- ** see section Engineering, Speeds
- *** see section Engineering, Deflection and Rigidity

Designation examples:

Sealed design

B7002-C-2RSD-T-P4S-UL
HSS7002-E-T-P4S-UL

Hybrid ceramic design

HC7002-E-T-P4S-UL
HCB71802-C-TPA-P4-UL

X-life ultra design

XCB7002-E-2RSD-T-P4S-UL
XC7002-E-T-P4S-UL

B718..C/E, B719, B70, B72 HS719..C/E, HS70

C: Contact angle $\alpha = 15^\circ$
E: Contact angle $\alpha = 25^\circ$

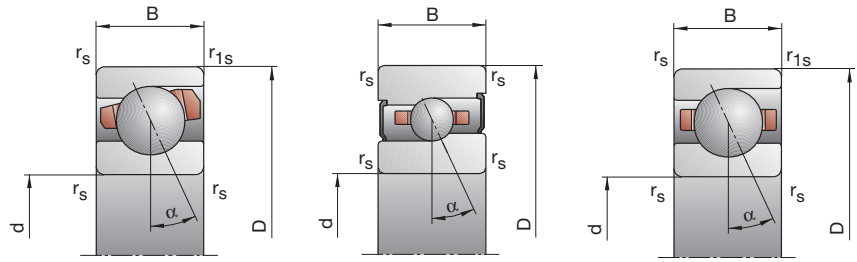

Attainable speed**		Preloading force F_V			Unloading force*** K_{aE}			Axial rigidity*** c_a			Sealed design*	Weight	Bearing code
Grease	Oil	L	M	H	L	M	H	L	M	H		kg	FAG
min ⁻¹	minimal	N						N/μm					
56 000	85 000	8	27	63	24	88	222	12,2	21,0	32,4	—	0,01	B71802-C-TPA-P4
50 000	75 000	8	34	91	23	99	277	25,3	42,4	63,5	—	0,01	B71802-E-TPA-P4
70 000	110 000	4	14	37	12	44	123	10,6	17,5	27,1	—	0,01	HCB71802-C-TPA-P4
63 000	95 000	7	22	54	20	64	161	27,0	40,8	57,4	—	0,01	HCB71802-E-TPA-P4
50 000	75 000	20	77	167	63	265	624	17,0	31,4	47,4	•	0,02	B71902-C-T-P4S
48 000	70 000	22	112	259	64	342	824	35,0	65,2	92,8	•	0,02	B71902-E-T-P4S
67 000	100 000	11	38	87	34	124	303	15,0	25,0	37,0	•	0,01	HCB71902-C-T-P4S
56 000	85 000	17	48	125	50	144	386	36,3	53,1	76,7	•	0,01	HCB71902-E-T-P4S
85 000	140 000	11	38	87	34	124	303	15,0	25,0	37,0	•	0,01	XCB71902-C-T-P4S
70 000	110 000	17	48	125	50	144	386	36,3	53,1	76,7	•	0,01	XCB71902-E-T-P4S
67 000	100 000	9	28	56	27	90	190	11,2	18,2	25,4	•	0,02	HS71902-C-T-P4S
56 000	85 000	15	46	92	43	136	279	27,8	42,4	55,7	•	0,02	HS71902-E-T-P4S
75 000	120 000	6	19	38	18	60	125	10,8	17,3	23,4	•	0,02	HC71902-C-T-P4S
67 000	95 000	11	32	63	32	95	190	28,5	42,0	54,1	•	0,02	HC71902-E-T-P4S
100 000	160 000	6	19	38	18	60	125	10,8	17,3	23,4	•	0,02	XC71902-C-T-P4S
85 000	140 000	11	32	63	32	95	190	28,5	42,0	54,1	•	0,02	XC71902-E-T-P4S
48 000	70 000	28	102	216	87	345	787	16,9	30,2	44,6	•	0,03	B7002-C-T-P4S
43 000	63 000	36	154	344	105	467	1080	37,4	64,8	90,3	•	0,03	B7002-E-T-P4S
60 000	90 000	11	51	114	33	164	388	13,0	24,4	35,4	•	0,03	HCB7002-C-T-P4S
50 000	75 000	18	68	166	53	203	508	33,4	53,5	75,2	•	0,03	HCB7002-E-T-P4S
75 000	120 000	11	51	114	33	164	388	13,0	24,4	35,4	•	0,03	XCB7002-C-T-P4S
67 000	100 000	18	68	166	53	203	508	33,4	53,5	75,2	•	0,03	XCB7002-E-T-P4S
60 000	90 000	13	38	75	39	122	254	13,8	22,0	30,4	•	0,03	HS7002-C-T-P4S
50 000	75 000	20	61	122	58	181	370	33,7	50,9	66,7	•	0,03	HS7002-E-T-P4S
70 000	110 000	9	26	52	27	82	171	13,5	20,9	28,3	•	0,03	HC7002-C-T-P4S
63 000	90 000	14	42	84	41	125	254	33,9	50,2	65,1	•	0,03	HC7002-E-T-P4S
90 000	150 000	9	26	52	27	82	171	13,5	20,9	28,3	•	0,03	XC7002-C-T-P4S
80 000	130 000	14	42	84	41	125	254	33,9	50,2	65,1	•	0,03	XC7002-E-T-P4S
45 000	67 000	47	165	347	149	575	1309	22,4	40,4	60,2	•	0,04	B7202-C-T-P4S
40 000	60 000	65	256	555	192	789	1779	50,2	85,3	118,6	•	0,04	B7202-E-T-P4S
56 000	85 000	21	86	186	64	283	653	17,9	32,7	47,5	•	0,04	HCB7202-C-T-P4S
48 000	70 000	24	123	286	71	372	892	40,1	72,1	100,5	•	0,04	HCB7202-E-T-P4S

FAG Spindle Bearings

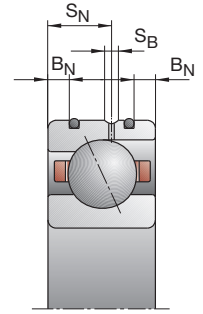
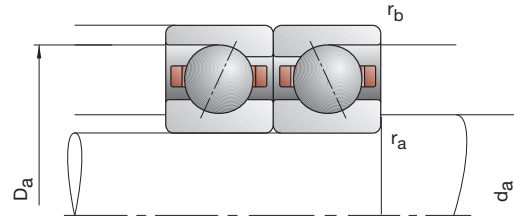
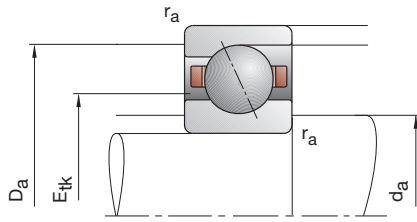

Bearing code	Dimensions					Abutment dimensions				DLR dimensions			Load rating			
	d	D	B	r _{smin}	r _{1smin}	d _a	D _a	r _a	r _b	B _N	S _N	S _B	E _{tk} nom.	C _{dyn}	C _{0stat}	
FAG	mm														kN	
B71803-C-TPA-P4	17	26	5	0,30	0,10	19	24	0,3	0,1				20,3	2,32	1,60	
B71803-E-TPA-P4	17	26	5	0,30	0,10	19	24	0,3	0,1				20,3	2,20	1,53	
HCB71803-C-TPA-P4	17	26	5	0,30	0,10	19	24	0,3	0,1				20,3	1,60	1,12	
HCB71803-E-TPA-P4	17	26	5	0,30	0,10	19	24	0,3	0,1				20,3	1,53	1,06	
B71903-C-T-P4S	17	30	7	0,30	0,30	20	27,5	0,3	0,3				22,2	5,30	3,15	
B71903-E-T-P4S	17	30	7	0,30	0,30	20	27,5	0,3	0,3				22,2	5,00	3,00	
HCB71903-C-T-P4S	17	30	7	0,30	0,30	20	27,5	0,3	0,3				22,2	3,65	2,20	
HCB71903-E-T-P4S	17	30	7	0,30	0,30	20	27,5	0,3	0,3				22,2	3,45	2,08	
XCB71903-C-T-P4S	17	30	7	0,30	0,30	20	27,5	0,3	0,3				22,2	8,15	2,20	
XCB71903-E-T-P4S	17	30	7	0,30	0,30	20	27,5	0,3	0,3				22,2	7,65	2,08	
HS71903-C-T-P4S	17	30	7	0,30		20	27,5	0,3	0,3				22,3	2,90	1,90	
HS71903-E-T-P4S	17	30	7	0,30		20	27,5	0,3	0,3				22,3	2,70	1,80	
HC71903-C-T-P4S	17	30	7	0,30		20	27,5	0,3	0,3				22,3	2,00	1,34	
HC71903-E-T-P4S	17	30	7	0,30		20	27,5	0,3	0,3				22,3	1,90	1,27	
XC71903-C-T-P4S	17	30	7	0,30		20	27,5	0,3	0,3				22,3	4,50	1,34	
XC71903-E-T-P4S	17	30	7	0,30		20	27,5	0,3	0,3				22,3	4,25	1,27	
B7003-C-T-P4S	17	35	10	0,30	0,30	21	32	0,3	0,1				24,1	8,65	4,90	
B7003-E-T-P4S	17	35	10	0,30	0,30	21	32	0,3	0,1				24,1	8,30	4,75	
HCB7003-C-T-P4S	17	35	10	0,30	0,30	21	32	0,3	0,1				24,1	6,00	3,45	
HCB7003-E-T-P4S	17	35	10	0,30	0,30	21	32	0,3	0,1				24,1	5,70	3,25	
XCB7003-C-T-P4S	17	35	10	0,30	0,30	21	32	0,3	0,1				24,1	13,40	3,45	
XCB7003-E-T-P4S	17	35	10	0,30	0,30	21	32	0,3	0,1				24,1	12,70	3,25	
HS7003-C-T-P4S	17	35	10	0,30		21	32	0,3	0,1				24,7	3,80	2,65	
HS7003-E-T-P4S	17	35	10	0,30		21	32	0,3	0,1				24,7	3,65	2,50	
HC7003-C-T-P4S	17	35	10	0,30		21	32	0,3	0,1				24,7	2,65	1,83	
HC7003-E-T-P4S	17	35	10	0,30		21	32	0,3	0,1				24,7	2,50	1,73	
XC7003-C-T-P4S	17	35	10	0,30		21	32	0,3	0,1				24,7	5,85	1,83	
XC7003-E-T-P4S	17	35	10	0,30		21	32	0,3	0,1				24,7	5,60	1,73	
B7203-C-T-P4S	17	40	12	0,60	0,60	22,5	34,5	0,6	0,6				26,7	10,80	5,85	
B7203-E-T-P4S	17	40	12	0,60	0,60	22,5	34,5	0,6	0,6				26,7	10,40	5,60	
HCB7203-C-T-P4S	17	40	12	0,60	0,60	22,5	34,5	0,6	0,6				26,7	7,50	4,05	
HCB7203-E-T-P4S	17	40	12	0,60	0,60	22,5	34,5	0,6	0,6				26,7	7,20	3,90	

- * options; • = possible, – = not possible
- ** see section Engineering, Speeds
- *** see section Engineering, Deflection and Rigidity

Designation examples:

Sealed design

B7003-C-2RSD-T-P4S-UL
HSS7003-E-T-P4S-UL

Hybrid ceramic design

HC7003-E-T-P4S-UL
HCB71803-C-TPA-P4-UL

X-life ultra design

XCB7003-E-2RSD-T-P4S-UL
XC7003-E-T-P4S-UL

B718..C/E, B719, B70, B72 HS719..C/E, HS70

C: Contact angle $\alpha = 15^\circ$
E: Contact angle $\alpha = 25^\circ$

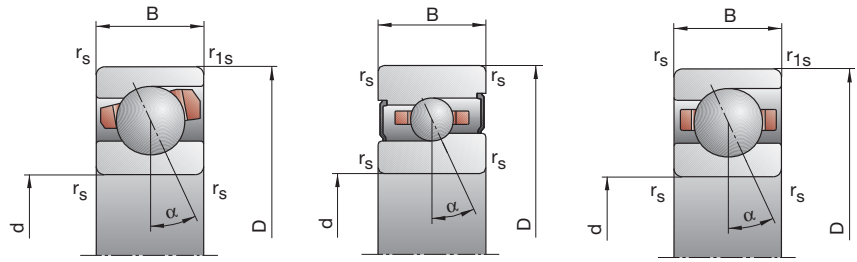

Attainable speed**		Preloading force F_V			Unloading force*** K_{aE}			Axial rigidity*** c_a			Sealed design*	Weight	Bearing code
Grease	Oil	L	M	H	L	M	H	L	M	H		kg	FAG
min ⁻¹	minimal	N						N/μm					
50000	75000	8	26	64	24	84	224	12,6	21,3	33,4	—	0,01	B71803-C-TPA-P4
48000	70000	7	33	92	20	96	279	24,9	43,5	65,8	—	0,01	B71803-E-TPA-P4
67000	100000	4	13	36	12	40	119	11,0	17,3	27,6	—	0,01	HCB71803-C-TPA-P4
56000	85000	7	22	53	20	64	158	28,0	42,3	59,1	—	0,01	HCB71803-E-TPA-P4
48000	70000	21	81	176	66	279	656	18,1	33,5	50,4	•	0,02	B71903-C-T-P4S
43000	63000	23	116	268	67	354	850	37,4	69,2	98,1	•	0,02	B71903-E-T-P4S
60000	90000	11	39	91	34	127	316	15,7	26,4	39,3	•	0,01	HCB71903-C-T-P4S
50000	75000	18	50	132	53	150	407	38,9	56,5	81,9	•	0,01	HCB71903-E-T-P4S
75000	120000	11	39	91	34	127	316	15,7	26,4	39,3	•	0,01	XCB71903-C-T-P4S
67000	100000	18	50	132	53	150	407	38,9	56,5	81,9	•	0,01	XCB71903-E-T-P4S
60000	90000	10	29	58	30	93	196	12,1	19,2	26,6	•	0,02	HS71903-C-T-P4S
50000	75000	16	47	94	46	139	285	29,7	44,5	58,5	•	0,02	HS71903-E-T-P4S
70000	110000	7	20	40	21	63	131	11,9	18,3	24,8	•	0,02	HC71903-C-T-P4S
63000	90000	11	32	64	32	95	193	29,7	43,8	56,7	•	0,02	HC71903-E-T-P4S
90000	150000	7	20	40	21	63	131	11,9	18,3	24,8	•	0,02	XC71903-C-T-P4S
75000	120000	11	32	64	32	95	193	29,7	43,8	56,7	•	0,02	XC71903-E-T-P4S
43000	63000	41	146	308	127	492	1115	21,3	37,8	55,4	•	0,04	B7003-C-T-P4S
38000	56000	54	221	487	158	668	1527	47,9	81,3	112,6	•	0,04	B7003-E-T-P4S
53000	80000	18	73	163	54	234	553	17,2	30,5	44,2	•	0,03	HCB7003-C-T-P4S
45000	67000	28	104	249	82	311	762	43,0	68,9	96,1	•	0,03	HCB7003-E-T-P4S
70000	110000	18	73	163	54	234	553	17,2	30,5	44,2	•	0,03	XCB7003-C-T-P4S
60000	90000	28	104	249	82	311	762	43,0	68,9	96,1	•	0,03	XCB7003-E-T-P4S
53000	80000	13	38	76	39	121	256	14,3	22,6	31,5	•	0,04	HS7003-C-T-P4S
45000	67000	21	62	124	61	183	375	35,7	53,0	69,5	•	0,04	HS7003-E-T-P4S
63000	95000	9	26	53	27	81	173	14,1	21,4	29,4	•	0,04	HC7003-C-T-P4S
56000	80000	14	43	86	41	127	259	35,3	52,3	68,0	•	0,04	HC7003-E-T-P4S
80000	130000	9	26	53	27	81	173	14,1	21,4	29,4	•	0,04	XC7003-C-T-P4S
70000	100000	14	43	86	41	127	259	35,3	52,3	68,0	•	0,04	XC7003-E-T-P4S
38000	56000	53	186	391	167	647	1470	23,7	42,9	63,7	•	0,06	B7203-C-T-P4S
36000	53000	75	289	626	222	891	2006	53,9	90,7	126,0	•	0,06	B7203-E-T-P4S
50000	75000	25	98	212	77	323	744	19,6	34,9	50,6	•	0,06	HCB7203-C-T-P4S
43000	63000	28	142	327	82	430	1020	42,7	77,3	107,3	•	0,06	HCB7203-E-T-P4S

FAG Spindle Bearings

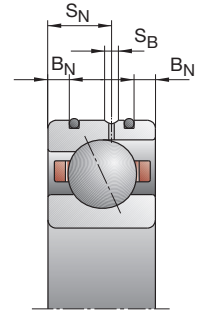
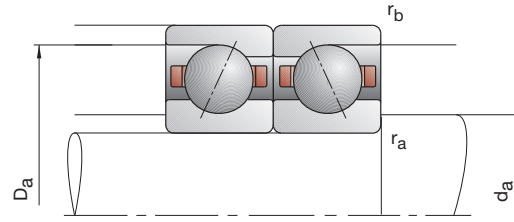
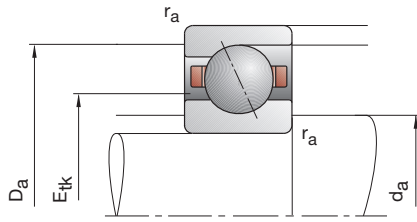

Bearing code	Dimensions					Abutment dimensions				DLR dimensions			Load rating			
	d	D	B	r _{smin}	r _{1smin}	d _a	D _a	r _a	r _b	B _N	S _N	S _B	E _{tk} nom.	C _{dyn}	C _{0stat}	
FAG	mm														kN	
B71804-C-TPA-P4	20	32	7	0,30	0,10	23	29	0,3	0,1				24,5	3,80	2,65	
B71804-E-TPA-P4	20	32	7	0,30	0,10	23	29	0,3	0,1				24,5	3,65	2,50	
HCB71804-C-TPA-P4	20	32	7	0,30	0,10	23	29	0,3	0,1				24,5	2,65	1,83	
HCB71804-E-TPA-P4	20	32	7	0,30	0,10	23	29	0,3	0,1				24,5	2,50	1,73	
B71904-C-T-P4S	20	37	9	0,30	0,30	24	33,5	0,3	0,3				26,8	7,35	4,55	
B71904-E-T-P4S	20	37	9	0,30	0,30	24	33,5	0,3	0,3				26,8	6,95	4,40	
HCB71904-C-T-P4S	20	37	9	0,30	0,30	24	33,5	0,3	0,3				26,8	5,00	3,20	
HCB71904-E-T-P4S	20	37	9	0,30	0,30	24	33,5	0,3	0,3				26,8	4,80	3,05	
XCB71904-C-T-P4S	20	37	9	0,30	0,30	24	33,5	0,3	0,3				26,8	11,20	3,20	
XCB71904-E-T-P4S	20	37	9	0,30	0,30	24	33,5	0,3	0,3				26,8	10,80	3,05	
HS71904-C-T-P4S	20	37	9	0,30		24	33,5	0,3	0,3				27,2	3,90	2,85	
HS71904-E-T-P4S	20	37	9	0,30		24	33,5	0,3	0,3				27,2	3,75	2,70	
HC71904-C-T-P4S	20	37	9	0,30		24	33,5	0,3	0,3				27,2	2,70	1,96	
HC71904-E-T-P4S	20	37	9	0,30		24	33,5	0,3	0,3				27,2	2,55	1,86	
XC71904-C-T-P4S	20	37	9	0,30		24	33,5	0,3	0,3				27,2	6,00	1,96	
XC71904-E-T-P4S	20	37	9	0,30		24	33,5	0,3	0,3				27,2	5,70	1,86	
B7004-C-T-P4S	20	42	12	0,60	0,60	25	37	0,6	0,3				28,8	10,40	6,00	
B7004-E-T-P4S	20	42	12	0,60	0,60	25	37	0,6	0,3				28,8	10,00	5,70	
HCB7004-C-T-P4S	20	42	12	0,60	0,60	25	37	0,6	0,3	2,2	6,6	1,4	28,8	7,20	4,15	
HCB7004-E-T-P4S	20	42	12	0,60	0,60	25	37	0,6	0,3	2,2	6,6	1,4	28,8	6,95	4,00	
XCB7004-C-T-P4S	20	42	12	0,60	0,60	25	37	0,6	0,3	2,2	6,6	1,4	28,8	16,00	4,15	
XCB7004-E-T-P4S	20	42	12	0,60	0,60	25	37	0,6	0,3	2,2	6,6	1,4	28,8	15,60	4,00	
HS7004-C-T-P4S	20	42	12	0,60		25	37	0,6	0,3				29,3	6,20	4,55	
HS7004-E-T-P4S	20	42	12	0,60		25	37	0,6	0,3				29,3	5,85	4,30	
HC7004-C-T-P4S	20	42	12	0,60		25	37	0,6	0,3	2,2	6,6	1,4	29,3	4,30	3,20	
HC7004-E-T-P4S	20	42	12	0,60		25	37	0,6	0,3	2,2	6,6	1,4	29,3	4,05	3,00	
XC7004-C-T-P4S	20	42	12	0,60		25	37	0,6	0,3	2,2	6,6	1,4	29,3	9,50	3,20	
XC7004-E-T-P4S	20	42	12	0,60		25	37	0,6	0,3	2,2	6,6	1,4	29,3	9,00	3,00	
B7204-C-T-P4S	20	47	14	1,00	1,00	26,5	40,5	1,0	1,0				31,7	14,60	8,15	
B7204-E-T-P4S	20	47	14	1,00	1,00	26,5	40,5	1,0	1,0				31,7	14,00	7,80	
HCB7204-C-T-P4S	20	47	14	1,00	1,00	26,5	40,5	1,0	1,0				31,7	10,00	5,60	
HCB7204-E-T-P4S	20	47	14	1,00	1,00	26,5	40,5	1,0	1,0				31,7	9,65	5,40	

- * options; • = possible, – = not possible
- ** see section Engineering, Speeds
- *** see section Engineering, Deflection and Rigidity

Designation examples:

Sealed design

B7004-C-2RSD-T-P4S-UL
HSS7004-E-T-P4S-UL

Hybrid ceramic design

HC7004-E-T-P4S-UL
HCB71804-C-TPA-P4-UL

Direct Lube design

HCB7004-EDLR-T-P4S-UL
HC7004-EDLR-T-P4S-UL

B718..C/E, B719, B70, B72 HS719..C/E, HS70

C: Contact angle $\alpha = 15^\circ$
E: Contact angle $\alpha = 25^\circ$

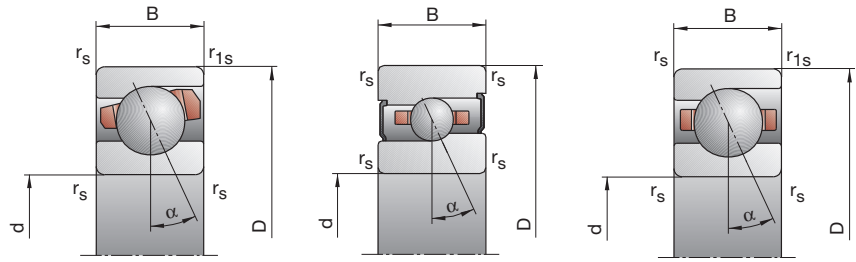

Attainable speed**		Preloading force F_V			Unloading force*** K_{aE}			Axial rigidity*** c_a			Sealed design*	Weight	Bearing code
Grease	Oil	L	M	H	L	M	H	L	M	H		kg	FAG
min ⁻¹	minimal	N						N/μm					
43 000	63 000	15	50	114	46	166	411	17,2	29,7	45,6	—	0,02	B71804-C-TPA-P4
38 000	56 000	18	70	174	52	208	539	37,3	61,8	90,2	—	0,02	B71804-E-TPA-P4
53 000	80 000	8	29	70	24	92	239	15,0	25,5	38,9	—	0,02	HCB71804-C-TPA-P4
45 000	67 000	13	48	108	38	142	328	37,9	60,4	82,8	—	0,02	HCB71804-E-TPA-P4
38 000	56 000	41	137	297	130	478	1 127	24,5	43,5	66,1	•	0,03	B71904-C-T-P4S
36 000	53 000	38	172	390	111	526	1 240	47,1	84,0	118,4	•	0,03	B71904-E-T-P4S
50 000	75 000	13	58	132	39	189	457	17,0	32,1	47,2	•	0,03	HCB71904-C-T-P4S
43 000	63 000	27	77	193	80	231	595	47,7	69,4	98,9	•	0,03	HCB71904-E-T-P4S
63 000	95 000	13	58	132	39	189	457	17,0	32,1	47,2	•	0,03	XCB71904-C-T-P4S
56 000	85 000	27	77	193	80	231	595	47,7	69,4	98,9	•	0,03	XCB71904-E-T-P4S
50 000	75 000	13	39	78	39	124	262	14,8	23,6	32,8	•	0,04	HS71904-C-T-P4S
43 000	63 000	21	63	127	61	186	384	37,1	55,3	72,7	•	0,04	HS71904-E-T-P4S
56 000	85 000	9	27	55	27	84	180	14,6	22,5	31,0	•	0,04	HC71904-C-T-P4S
50 000	70 000	15	44	89	44	130	268	37,6	54,7	71,4	•	0,04	HC71904-E-T-P4S
75 000	120 000	9	27	55	27	84	180	14,6	22,5	31,0	•	0,04	XC71904-C-T-P4S
63 000	95 000	15	44	89	44	130	268	37,6	54,7	71,4	•	0,04	XC71904-E-T-P4S
36 000	53 000	52	179	377	161	604	1 369	22,8	40,0	58,8	•	0,07	B7004-C-T-P4S
32 000	48 000	71	277	598	207	839	1 879	51,7	86,7	119,3	•	0,07	B7004-E-T-P4S
45 000	67 000	24	94	203	73	303	692	18,9	33,0	47,2	•	0,06	HCB7004-C-T-P4S
38 000	56 000	26	132	305	76	394	934	41,3	73,6	101,6	•	0,06	HCB7004-E-T-P4S
60 000	90 000	24	94	203	73	303	692	18,9	33,0	47,2	•	0,06	XCB7004-C-T-P4S
50 000	75 000	26	132	305	76	394	934	41,3	73,6	101,6	•	0,06	XCB7004-E-T-P4S
45 000	67 000	21	62	125	63	198	420	19,8	31,5	43,7	•	0,08	HS7004-C-T-P4S
38 000	56 000	34	101	202	98	299	610	49,1	73,6	96,3	•	0,08	HS7004-E-T-P4S
53 000	80 000	15	44	87	45	138	284	19,7	30,3	40,9	•	0,08	HC7004-C-T-P4S
48 000	67 000	23	70	140	67	207	421	48,8	72,6	94,2	•	0,08	HC7004-E-T-P4S
67 000	100 000	15	44	87	45	138	284	19,7	30,3	40,9	•	0,08	XC7004-C-T-P4S
56 000	85 000	23	70	140	67	207	421	48,8	72,6	94,2	•	0,08	XC7004-E-T-P4S
32 000	48 000	74	252	527	229	856	1 934	27,8	49,4	73,1	•	0,10	B7204-C-T-P4S
30 000	45 000	105	393	843	304	1 184	2 644	63,0	105,0	145,2	•	0,10	B7204-E-T-P4S
43 000	63 000	45	163	347	137	533	1 211	25,4	44,3	64,3	•	0,09	HCB7204-C-T-P4S
36 000	53 000	56	242	538	162	724	1 655	56,9	97,9	134,4	•	0,09	HCB7204-E-T-P4S

X-life ultra design

XCB7004-EDLR-T-P4S-UL
XC7004-EDLR-T-P4S-UL

TX design

HCB7004-C-TX-P4S-UL
XC7004-EDLR-TX-P4S-UL

FAG Spindle Bearings

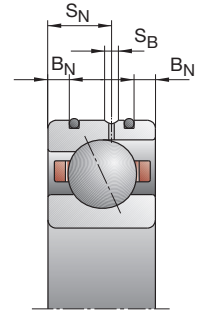
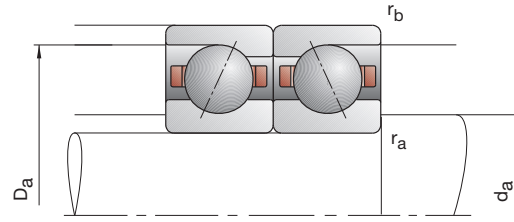
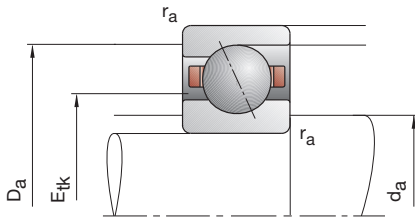

Bearing code	Dimensions					Abutment dimensions				DLR dimensions			Load rating			
	d	D	B	r _{smin}	r _{1smin}	d _a	D _a	r _a	r _b	B _N	S _N	S _B	E _{tk} nom.	C _{dyn}	C _{0stat}	
FAG	mm														kN	
B71805-C-TPA-P4	25	37	7	0,30	0,10	28	34	0,3	0,1				29,5	4,15	3,20	
B71805-E-TPA-P4	25	37	7	0,30	0,10	28	34	0,3	0,1				29,5	3,90	3,00	
HCB71805-C-TPA-P4	25	37	7	0,30	0,10	28	34	0,3	0,1				29,5	2,85	2,24	
HCB71805-E-TPA-P4	25	37	7	0,30	0,10	28	34	0,3	0,1				29,5	2,70	2,12	
B71905-C-T-P4S	25	42	9	0,30	0,30	29	38,5	0,3	0,3				31,8	8,15	5,70	
B71905-E-T-P4S	25	42	9	0,30	0,30	29	38,5	0,3	0,3				31,8	7,80	5,50	
HCB71905-C-T-P4S	25	42	9	0,30	0,30	29	38,5	0,3	0,3				31,8	5,60	4,00	
HCB71905-E-T-P4S	25	42	9	0,30	0,30	29	38,5	0,3	0,3				31,8	5,30	3,80	
XCB71905-C-T-P4S	25	42	9	0,30	0,30	29	38,5	0,3	0,3				31,8	12,50	4,00	
XCB71905-E-T-P4S	25	42	9	0,30	0,30	29	38,5	0,3	0,3				31,8	11,80	3,80	
HS71905-C-T-P4S	25	42	9	0,30		29	38,5	0,3	0,3				32,2	4,25	3,35	
HS71905-E-T-P4S	25	42	9	0,30		29	38,5	0,3	0,3				32,2	4,00	3,15	
HC71905-C-T-P4S	25	42	9	0,30		29	38,5	0,3	0,3				32,2	2,90	2,36	
HC71905-E-T-P4S	25	42	9	0,30		29	38,5	0,3	0,3				32,2	2,75	2,20	
XC71905-C-T-P4S	25	42	9	0,30		29	38,5	0,3	0,3				32,2	6,40	2,36	
XC71905-E-T-P4S	25	42	9	0,30		29	38,5	0,3	0,3				32,2	6,10	2,20	
B7005-C-T-P4S	25	47	12	0,60	0,60	30	42	0,6	0,3				33,5	14,60	9,15	
B7005-E-T-P4S	25	47	12	0,60	0,60	30	42	0,6	0,3				33,5	13,70	8,65	
HCB7005-C-T-P4S	25	47	12	0,60	0,60	30	42	0,6	0,3	2,2	6,6	1,4	33,5	10,00	6,30	
HCB7005-E-T-P4S	25	47	12	0,60	0,60	30	42	0,6	0,3	2,2	6,6	1,4	33,5	9,50	6,00	
XCB7005-C-T-P4S	25	47	12	0,60	0,60	30	42	0,6	0,3	2,2	6,6	1,4	33,5	22,40	6,30	
XCB7005-E-T-P4S	25	47	12	0,60	0,60	30	42	0,6	0,3	2,2	6,6	1,4	33,5	21,20	6,00	
HS7005-C-T-P4S	25	47	12	0,60		30	42	0,6	0,3				34,3	6,30	4,90	
HS7005-E-T-P4S	25	47	12	0,60		30	42	0,6	0,3				34,3	6,00	4,65	
HC7005-C-T-P4S	25	47	12	0,60		30	42	0,6	0,3	2,2	6,6	1,4	34,3	4,30	3,45	
HC7005-E-T-P4S	25	47	12	0,60		30	42	0,6	0,3	2,2	6,6	1,4	34,3	4,05	3,25	
XC7005-C-T-P4S	25	47	12	0,60		30	42	0,6	0,3	2,2	6,6	1,4	34,3	9,65	3,45	
XC7005-E-T-P4S	25	47	12	0,60		30	42	0,6	0,3	2,2	6,6	1,4	34,3	9,00	3,25	
B7205-C-T-P4S	25	52	15	1,00	1,00	31,5	45,5	1,0	1,0				36,5	15,60	9,30	
B7205-E-T-P4S	25	52	15	1,00	1,00	31,5	45,5	1,0	1,0				36,5	15,00	9,00	
HCB7205-C-T-P4S	25	52	15	1,00	1,00	31,5	45,5	1,0	1,0				36,5	10,80	6,55	
HCB7205-E-T-P4S	25	52	15	1,00	1,00	31,5	45,5	1,0	1,0				36,5	10,40	6,20	

- * options; • = possible, – = not possible
- ** see section Engineering, Speeds
- *** see section Engineering, Deflection and Rigidity

Designation examples:

Sealed design

B7005-C-2RSD-T-P4S-UL
HSS7005-E-T-P4S-UL

Hybrid ceramic design

HC7005-E-T-P4S-UL
HCB71805-C-TPA-P4-UL

Direct Lube design

HCB7005-EDLR-T-P4S-UL
HC7005-EDLR-T-P4S-UL

B718..C/E, B719, B70, B72 HS719..C/E, HS70

C: Contact angle $\alpha = 15^\circ$
E: Contact angle $\alpha = 25^\circ$

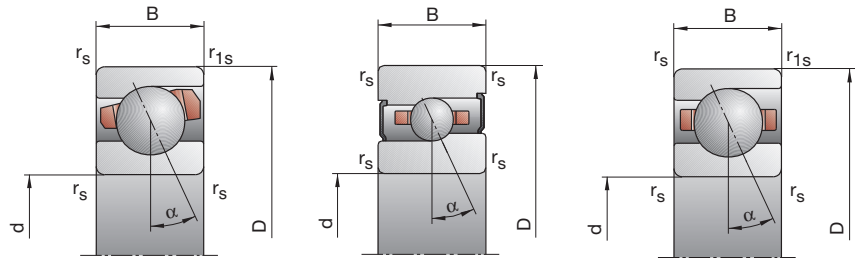

Attainable speed**		Preloading force F_V			Unloading force*** K_{aE}			Axial rigidity*** c_a			Sealed design*	Weight	Bearing code
Grease	Oil	L	M	H	L	M	H	L	M	H		kg	FAG
min ⁻¹	minimal	N						N/μm					
36 000	53 000	16	54	123	49	178	439	19,5	33,5	51,2	—	0,02	B71805-C-TPA-P4
32 000	48 000	18	72	181	52	213	557	41,5	69,0	100,6	—	0,02	B71805-E-TPA-P4
45 000	67 000	8	29	73	24	91	247	16,6	27,9	43,2	—	0,02	HCB71805-C-TPA-P4
38 000	56 000	11	49	110	32	144	333	39,7	67,1	92,2	—	0,02	HCB71805-E-TPA-P4
32 000	48 000	40	141	326	125	484	1 221	27,0	48,6	75,7	•	0,04	B71905-C-T-P4S
30 000	45 000	40	189	430	117	575	1 358	54,5	97,9	137,7	•	0,04	B71905-E-T-P4S
43 000	63 000	13	64	147	39	207	505	19,3	37,3	54,9	•	0,04	HCB71905-C-T-P4S
36 000	53 000	30	84	214	88	251	658	55,7	80,9	116,0	•	0,04	HCB71905-E-T-P4S
53 000	80 000	13	64	147	39	207	505	19,3	37,3	54,9	•	0,04	XCB71905-C-T-P4S
48 000	70 000	30	84	214	88	251	658	55,7	80,9	116,0	•	0,04	XCB71905-E-T-P4S
43 000	63 000	14	42	84	42	133	280	16,8	26,6	36,8	•	0,05	HS71905-C-T-P4S
36 000	53 000	23	69	138	66	203	416	41,9	62,9	82,4	•	0,05	HS71905-E-T-P4S
48 000	70 000	10	29	58	30	90	188	16,7	25,4	34,4	•	0,05	HC71905-C-T-P4S
43 000	60 000	16	47	94	47	139	282	42,6	62,0	80,1	•	0,05	HC71905-E-T-P4S
63 000	95 000	10	29	58	30	90	188	16,7	25,4	34,4	•	0,05	XC71905-C-T-P4S
53 000	80 000	16	47	94	47	139	282	42,6	62,0	80,1	•	0,05	XC71905-E-T-P4S
30 000	45 000	74	254	533	229	852	1 921	29,7	51,8	75,7	•	0,08	B7005-C-T-P4S
28 000	43 000	101	384	828	295	1 161	2 586	67,6	111,9	153,4	•	0,08	B7005-E-T-P4S
38 000	56 000	34	130	281	103	416	950	24,6	42,4	60,4	•	0,06	HCB7005-C-T-P4S
34 000	50 000	39	189	431	114	564	1 318	54,9	96,4	132,1	•	0,06	HCB7005-E-T-P4S
50 000	75 000	34	130	281	103	416	950	24,6	42,4	60,4	•	0,06	XCB7005-C-T-P4S
43 000	63 000	39	189	431	114	564	1 318	54,9	96,4	132,1	•	0,06	XCB7005-E-T-P4S
38 000	56 000	21	64	127	63	204	426	20,5	32,9	45,3	•	0,09	HS7005-C-T-P4S
34 000	50 000	35	104	207	101	307	624	51,4	76,7	100,3	•	0,09	HS7005-E-T-P4S
45 000	67 000	15	44	87	45	138	283	20,3	31,3	42,1	•	0,09	HC7005-C-T-P4S
40 000	56 000	24	71	143	70	210	430	51,3	75,5	98,1	•	0,09	HC7005-E-T-P4S
60 000	90 000	15	44	87	45	138	283	20,3	31,3	42,1	•	0,09	XC7005-C-T-P4S
50 000	75 000	24	71	143	70	210	430	51,3	75,5	98,1	•	0,09	XC7005-E-T-P4S
28 000	43 000	79	269	562	244	911	2 054	30,2	53,5	79,0	•	0,12	B7205-C-T-P4S
26 000	40 000	113	420	901	327	1 264	2 821	68,8	114,2	157,7	•	0,12	B7205-E-T-P4S
36 000	53 000	47	172	367	142	560	1 275	27,3	47,8	69,2	•	0,11	HCB7205-C-T-P4S
32 000	48 000	58	252	563	168	750	1 728	61,4	105,2	144,9	•	0,11	HCB7205-E-T-P4S

X-life ultra design

XCB7005-E-2RSD-T-P4S-UL
XC7005-EDLR-T-P4S-UL

TX design

HCB7005-C-TX-P4S-UL
XC7005-EDLR-TX-P4S-UL

FAG Spindle Bearings

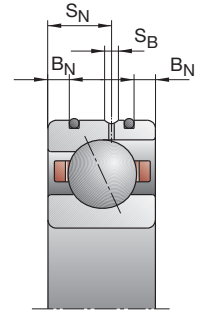
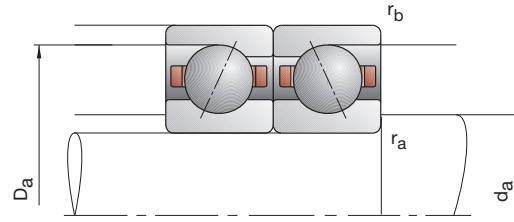
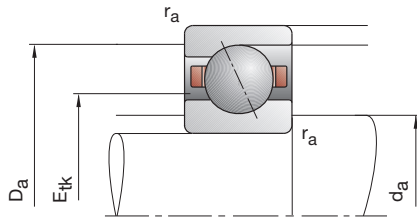

Bearing code	Dimensions					Abutment dimensions				DLR dimensions			Load rating		
	d	D	B	r _{smin}	r _{1smin}	d _a	D _a	r _a	r _b	B _N	S _N	S _B	E _{tk} nom.	C _{dyn}	C _{0stat}
FAG	mm														
B71806-C-TPA-P4	30	42	7	0,30	0,10	33	39	0,3	0,1				34,5	4,40	3,65
B71806-E-TPA-P4	30	42	7	0,30	0,10	33	39	0,3	0,1				34,5	4,15	3,40
HCB71806-C-TPA-P4	30	42	7	0,30	0,10	33	39	0,3	0,1				34,5	3,05	2,55
HCB71806-E-TPA-P4	30	42	7	0,30	0,10	33	39	0,3	0,1				34,5	2,85	2,40
B71906-C-T-P4S	30	47	9	0,30	0,30	34	43,5	0,3	0,3				36,8	8,65	6,55
B71906-E-T-P4S	30	47	9	0,30	0,30	34	43,5	0,3	0,3				36,8	8,15	6,30
HCB71906-C-T-P4S	30	47	9	0,30	0,30	34	43,5	0,3	0,3	1,1	5,3	1,4	36,8	6,00	4,65
HCB71906-E-T-P4S	30	47	9	0,30	0,30	34	43,5	0,3	0,3	1,1	5,3	1,4	36,8	5,60	4,40
XCB71906-C-T-P4S	30	47	9	0,30	0,30	34	43,5	0,3	0,3	1,1	5,3	1,4	36,8	13,40	4,65
XCB71906-E-T-P4S	30	47	9	0,30	0,30	34	43,5	0,3	0,3	1,1	5,3	1,4	36,8	12,50	4,40
HS71906-C-T-P4S	30	47	9	0,30		34	43,5	0,3	0,3				36,8	6,40	5,20
HS71906-E-T-P4S	30	47	9	0,30		34	43,5	0,3	0,3				36,8	6,00	4,90
HC71906-C-T-P4S	30	47	9	0,30		34	43,5	0,3	0,3	1,1	5,3	1,4	36,8	4,40	3,65
HC71906-E-T-P4S	30	47	9	0,30		34	43,5	0,3	0,3	1,1	5,3	1,4	36,8	4,15	3,45
XC71906-C-T-P4S	30	47	9	0,30		34	43,5	0,3	0,3	1,1	5,3	1,4	36,8	9,80	3,65
XC71906-E-T-P4S	30	47	9	0,30		34	43,5	0,3	0,3	1,1	5,3	1,4	36,8	9,30	3,45
B7006-C-T-P4S	30	55	13	1,00	1,00	36	49	1,0	0,3				40,4	15,00	10,20
B7006-E-T-P4S	30	55	13	1,00	1,00	36	49	1,0	0,3				40,4	14,30	9,80
HCB7006-C-T-P4S	30	55	13	1,00	1,00	36	49	1,0	0,3	2,8	7,2	1,4	40,4	10,40	7,20
HCB7006-E-T-P4S	30	55	13	1,00	1,00	36	49	1,0	0,3	2,8	7,2	1,4	40,4	10,00	6,80
XCB7006-C-T-P4S	30	55	13	1,00	1,00	36	49	1,0	0,3	2,8	7,2	1,4	40,4	23,20	7,20
XCB7006-E-T-P4S	30	55	13	1,00	1,00	36	49	1,0	0,3	2,8	7,2	1,4	40,4	22,40	6,80
HS7006-C-T-P4S	30	55	13	1,00		36	49	1,0	0,3				40,5	8,80	7,10
HS7006-E-T-P4S	30	55	13	1,00		36	49	1,0	0,3				40,5	8,30	6,70
HC7006-C-T-P4S	30	55	13	1,00		36	49	1,0	0,3	2,8	7,2	1,4	40,5	6,00	4,90
HC7006-E-T-P4S	30	55	13	1,00		36	49	1,0	0,3	2,8	7,2	1,4	40,5	5,70	4,65
XC7006-C-T-P4S	30	55	13	1,00		36	49	1,0	0,3	2,8	7,2	1,4	40,5	13,40	4,90
XC7006-E-T-P4S	30	55	13	1,00		36	49	1,0	0,3	2,8	7,2	1,4	40,5	12,70	4,65
B7206-C-T-P4S	30	62	16	1,00	1,00	37,5	54,5	1,0	1,0				43,7	23,20	14,60
B7206-E-T-P4S	30	62	16	1,00	1,00	37,5	54,5	1,0	1,0				43,7	22,00	14,00
HCB7206-C-T-P4S	30	62	16	1,00	1,00	37,5	54,5	1,0	1,0				43,7	16,00	10,20
HCB7206-E-T-P4S	30	62	16	1,00	1,00	37,5	54,5	1,0	1,0				43,7	15,30	9,80

- * options; • = possible, – = not possible
- ** see section Engineering, Speeds
- *** see section Engineering, Deflection and Rigidity

Designation examples:

Sealed design

B7006-C-2RSD-T-P4S-UL
HSS7006-E-T-P4S-UL

Hybrid ceramic design

HC7006-E-T-P4S-UL
HCB71806-C-TPA-P4-UL

Direct Lube design

HCB7006-EDLR-T-P4S-UL
HC7006-EDLR-T-P4S-UL

B718..C/E, B719, B70, B72 HS719..C/E, HS70

C: Contact angle $\alpha = 15^\circ$
E: Contact angle $\alpha = 25^\circ$

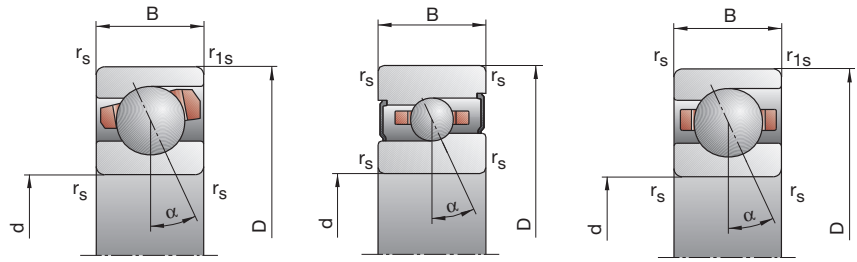

Attainable speed**		Preloading force F_V			Unloading force*** K_{aE}			Axial rigidity*** c_a			Sealed design*	Weight	Bearing code
Grease	Oil	L	M	H	L	M	H	L	M	H		kg	FAG
min ⁻¹	minimal	N						N/μm					
30000	45000	16	56	129	48	183	456	20,9	36,6	56,0	—	0,03	B71806-C-TPA-P4
28000	43000	18	73	189	51	215	578	44,6	75,5	110,9	—	0,03	B71806-E-TPA-P4
38000	56000	8	30	75	24	94	251	18,2	30,8	46,9	—	0,03	HCB71806-C-TPA-P4
34000	50000	13	48	111	37	141	334	45,1	72,9	100,5	—	0,03	HCB71806-E-TPA-P4
28000	43000	42	158	345	131	542	1284	29,5	54,3	82,1	•	0,05	B71906-C-T-P4S
26000	40000	40	194	445	117	588	1399	58,7	105,7	148,9	•	0,05	B71906-E-T-P4S
36000	53000	14	66	153	42	212	522	21,3	40,2	59,2	•	0,04	HCB71906-C-T-P4S
32000	48000	30	86	223	88	257	683	59,9	87,7	125,9	•	0,04	HCB71906-E-T-P4S
48000	70000	14	66	153	42	212	522	21,3	40,2	59,2	•	0,04	XCB71906-C-T-P4S
40000	60000	30	86	223	88	257	683	59,9	87,7	125,9	•	0,04	XCB71906-E-T-P4S
36000	53000	21	64	129	63	203	431	21,1	33,7	46,8	•	0,05	HS71906-C-T-P4S
32000	48000	35	105	209	101	310	629	53,1	79,4	103,6	•	0,05	HS71906-E-T-P4S
43000	63000	15	45	90	45	141	292	21,0	32,6	43,9	•	0,05	HC71906-C-T-P4S
38000	53000	24	72	145	70	213	435	53,0	78,3	101,5	•	0,05	HC71906-E-T-P4S
53000	80000	15	45	90	45	141	292	21,0	32,6	43,9	•	0,05	XC71906-C-T-P4S
48000	70000	24	72	145	70	213	435	53,0	78,3	101,5	•	0,05	XC71906-E-T-P4S
26000	40000	75	260	545	234	885	1998	32,7	57,8	85,1	•	0,11	B7006-C-T-P4S
24000	38000	102	397	861	300	1211	2721	74,1	124,1	171,3	•	0,11	B7006-E-T-P4S
32000	48000	35	137	297	107	445	1022	27,2	47,7	68,5	•	0,10	HCB7006-C-T-P4S
28000	43000	38	193	446	111	580	1377	58,9	106,0	146,6	•	0,10	HCB7006-E-T-P4S
43000	60000	35	137	297	107	445	1022	27,2	47,7	68,5	•	0,10	XCB7006-C-T-P4S
36000	53000	38	193	446	111	580	1377	58,9	106,0	146,6	•	0,10	XCB7006-E-T-P4S
32000	48000	29	88	176	87	280	589	24,2	38,7	53,4	•	0,13	HS7006-C-T-P4S
28000	43000	48	143	285	139	422	859	60,8	90,6	118,3	•	0,13	HS7006-E-T-P4S
38000	56000	20	61	122	60	190	397	23,8	36,9	50,0	•	0,12	HC7006-C-T-P4S
34000	48000	33	99	198	96	293	595	60,5	89,6	115,9	•	0,12	HC7006-E-T-P4S
50000	75000	20	61	122	60	190	397	23,8	36,9	50,0	•	0,12	XC7006-C-T-P4S
40000	60000	33	99	198	96	293	595	60,5	89,6	115,9	•	0,12	XC7006-E-T-P4S
24000	38000	122	412	856	388	1445	3250	42,1	75,5	112,3	•	0,19	B7206-C-T-P4S
22000	36000	175	637	1357	517	1967	4361	94,8	157,3	217,9	•	0,19	B7206-E-T-P4S
30000	45000	75	268	566	233	902	2040	38,4	67,5	98,3	•	0,17	HCB7206-C-T-P4S
26000	40000	100	407	895	295	1243	2820	87,5	148,0	203,6	•	0,17	HCB7206-E-T-P4S

X-life ultra design

XCB7006-E-2RSD-T-P4S-UL
XC7006-EDLR-T-P4S-UL

TX design

HCB7006-C-TX-P4S-UL
XC7006-EDLR-TX-P4S-UL

FAG Spindle Bearings

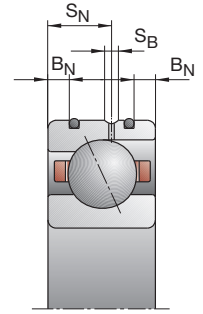
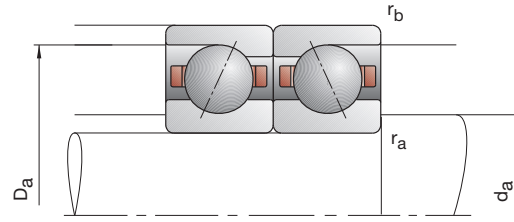
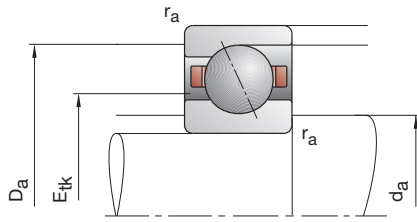

Bearing code	Dimensions					Abutment dimensions				DLR dimensions			Load rating		
	d	D	B	r _{smin}	r _{1smin}	d _a	D _a	r _a	r _b	B _N	S _N	S _B	E _{tk} nom.	C _{dyn}	C _{0stat}
FAG	mm													kN	
B71807-C-TPA-P4	35	47	7	0,30	0,10	38	44	0,3	0,1				39,5	4,65	4,15
B71807-E-TPA-P4	35	47	7	0,30	0,10	38	44	0,3	0,1				39,5	4,40	3,80
HCB71807-C-TPA-P4	35	47	7	0,30	0,10	38	44	0,3	0,1				39,5	3,20	2,85
HCB71807-E-TPA-P4	35	47	7	0,30	0,10	38	44	0,3	0,1				39,5	3,00	2,65
B71907-C-T-P4S	35	55	10	0,60	0,60	40	51,5	0,6	0,6				44,0	11,80	9,50
B71907-E-T-P4S	35	55	10	0,60	0,60	40	51,5	0,6	0,6				44,0	11,00	9,00
HCB71907-C-T-P4S	35	55	10	0,60	0,60	40	51,5	0,6	0,6	1,6	5,8	1,4	44,0	8,15	6,55
HCB71907-E-T-P4S	35	55	10	0,60	0,60	40	51,5	0,6	0,6	1,6	5,8	1,4	44,0	7,65	6,30
XCB71907-C-T-P4S	35	55	10	0,60	0,60	40	51,5	0,6	0,6	1,6	5,8	1,4	44,0	18,00	6,55
XCB71907-E-T-P4S	35	55	10	0,60	0,60	40	51,5	0,6	0,6	1,6	5,8	1,4	44,0	17,00	6,30
HS71907-C-T-P4S	35	55	10	0,60		40	51,5	0,6	0,6				43,3	6,95	6,20
HS71907-E-T-P4S	35	55	10	0,60		40	51,5	0,6	0,6				43,3	6,55	5,85
HC71907-C-T-P4S	35	55	10	0,60		40	51,5	0,6	0,6	1,6	5,8	1,4	43,3	4,80	4,40
HC71907-E-T-P4S	35	55	10	0,60		40	51,5	0,6	0,6	1,6	5,8	1,4	43,3	4,50	4,05
XC71907-C-T-P4S	35	55	10	0,60		40	51,5	0,6	0,6	1,6	5,8	1,4	43,3	10,80	4,40
XC71907-E-T-P4S	35	55	10	0,60		40	51,5	0,6	0,6	1,6	5,8	1,4	43,3	10,00	4,05
B7007-C-T-P4S	35	62	14	1,00	1,00	41	56	1,0	0,3				45,6	19,00	13,70
B7007-E-T-P4S	35	62	14	1,00	1,00	41	56	1,0	0,3				45,6	18,30	12,90
HCB7007-C-T-P4S	35	62	14	1,00	1,00	41	56	1,0	0,3	2,8	8,0	1,4	45,6	13,20	9,50
HCB7007-E-T-P4S	35	62	14	1,00	1,00	41	56	1,0	0,3	2,8	8,0	1,4	45,6	12,50	9,00
XCB7007-C-T-P4S	35	62	14	1,00	1,00	41	56	1,0	0,3	2,8	8,0	1,4	45,6	29,00	9,50
XCB7007-E-T-P4S	35	62	14	1,00	1,00	41	56	1,0	0,3	2,8	8,0	1,4	45,6	28,00	9,00
HS7007-C-T-P4S	35	62	14	1,00		41	56	1,0	0,3				46,5	9,30	8,30
HS7007-E-T-P4S	35	62	14	1,00		41	56	1,0	0,3				46,5	8,80	7,80
HC7007-C-T-P4S	35	62	14	1,00		41	56	1,0	0,3	2,8	8,0	1,4	46,5	6,40	5,85
HC7007-E-T-P4S	35	62	14	1,00		41	56	1,0	0,3	2,8	8,0	1,4	46,5	6,10	5,40
XC7007-C-T-P4S	35	62	14	1,00		41	56	1,0	0,3	2,8	8,0	1,4	46,5	14,30	5,85
XC7007-E-T-P4S	35	62	14	1,00		41	56	1,0	0,3	2,8	8,0	1,4	46,5	13,70	5,40
B7207-C-T-P4S	35	72	17	1,10	1,10	44	63	1,0	1,0				50,7	25,50	18,00
B7207-E-T-P4S	35	72	17	1,10	1,10	44	63	1,0	1,0				50,7	24,50	17,00
HCB7207-C-T-P4S	35	72	17	1,10	1,10	44	63	1,0	1,0				50,7	17,60	8,80
HCB7207-E-T-P4S	35	72	17	1,10	1,10	44	63	1,0	1,0				50,7	16,60	8,50

- * options; • = possible, – = not possible
- ** see section Engineering, Speeds
- *** see section Engineering, Deflection and Rigidity

Designation examples:

Sealed design

B7007-C-2RSD-T-P4S-UL
HSS7007-E-T-P4S-UL

Hybrid ceramic design

HC7007-E-T-P4S-UL
HCB71807-C-TPA-P4-UL

Direct Lube design

HCB7007-EDLR-T-P4S-UL
HC7007-EDLR-T-P4S-UL

B718..C/E, B719, B70, B72 HS719..C/E, HS70

C: Contact angle $\alpha = 15^\circ$
E: Contact angle $\alpha = 25^\circ$

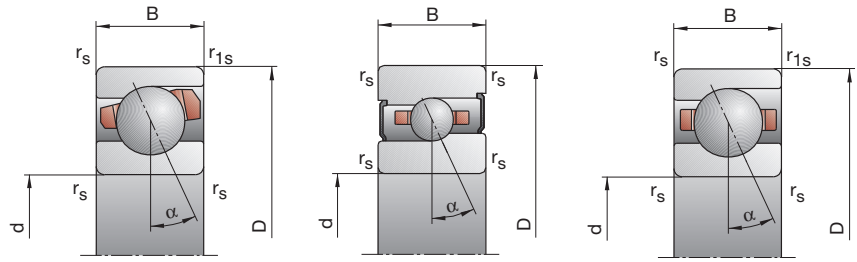

Attainable speed**		Preloading force F_V			Unloading force*** K_{aE}			Axial rigidity*** c_a			Sealed design*	Weight	Bearing code
Grease	Oil	L	M	H	L	M	H	L	M	H		kg	FAG
min ⁻¹	minimal	N						N/μm					
26 000	40 000	17	58	135	51	189	473	23,1	39,9	60,7	—	0,03	B71807-C-TPA-P4
24 000	38 000	19	76	197	54	223	601	49,4	82,6	121,4	—	0,03	B71807-E-TPA-P4
34 000	50 000	9	30	78	27	93	259	20,6	32,9	50,9	—	0,03	HCB71807-C-TPA-P4
30 000	45 000	13	48	112	37	141	336	48,8	78,9	108,7	—	0,03	HCB71807-E-TPA-P4
24 000	38 000	61	209	481	190	711	1 782	36,3	64,1	99,3	•	0,07	B71907-C-T-P4S
22 000	36 000	61	276	619	178	835	1 945	73,5	129,4	180,6	•	0,07	B71907-E-T-P4S
32 000	48 000	21	96	217	63	309	741	26,7	49,7	72,4	•	0,06	HCB71907-C-T-P4S
26 000	40 000	44	127	316	129	380	968	74,1	108,9	154,0	•	0,06	HCB71907-E-T-P4S
40 000	60 000	21	96	217	63	309	741	26,7	49,7	72,4	•	0,06	XCB71907-C-T-P4S
34 000	50 000	44	127	316	129	380	968	74,1	108,9	154,0	•	0,06	XCB71907-E-T-P4S
32 000	48 000	24	71	142	72	224	471	24,8	38,9	53,6	•	0,08	HS71907-C-T-P4S
26 000	40 000	38	115	230	110	339	690	61,4	91,7	119,6	•	0,08	HS71907-E-T-P4S
36 000	53 000	16	49	98	48	152	316	24,0	37,1	50,1	•	0,08	HC71907-C-T-P4S
32 000	45 000	26	79	159	75	233	476	60,5	90,4	117,1	•	0,08	HC71907-E-T-P4S
48 000	70 000	16	49	98	48	152	316	24,0	37,1	50,1	•	0,08	XC71907-C-T-P4S
40 000	60 000	26	79	159	75	233	476	60,5	90,4	117,1	•	0,08	XC71907-E-T-P4S
22 000	36 000	97	333	697	303	1 132	2 548	38,7	67,8	99,5	•	0,15	B7007-C-T-P4S
20 000	34 000	136	518	1 116	400	1 577	3 525	88,4	146,9	202,1	•	0,15	B7007-E-T-P4S
28 000	43 000	46	177	382	140	574	1 312	32,2	56,2	80,5	•	0,13	HCB7007-C-T-P4S
24 000	38 000	54	255	581	159	767	1 789	72,4	126,2	173,3	•	0,13	HCB7007-E-T-P4S
38 000	56 000	46	177	382	140	574	1 312	32,2	56,2	80,5	•	0,13	XCB7007-C-T-P4S
32 000	48 000	54	255	581	159	767	1 789	72,4	126,2	173,3	•	0,13	XCB7007-E-T-P4S
28 000	43 000	32	95	190	96	300	632	27,4	43,1	59,5	•	0,17	HS7007-C-T-P4S
24 000	38 000	51	154	308	147	453	926	67,8	101,5	132,7	•	0,17	HS7007-E-T-P4S
34 000	50 000	22	66	131	66	205	424	26,9	41,3	55,7	•	0,17	HC7007-C-T-P4S
30 000	43 000	36	107	214	105	316	642	68,5	100,6	130,2	•	0,17	HC7007-E-T-P4S
43 000	63 000	22	66	131	66	205	424	26,9	41,3	55,7	•	0,17	XC7007-C-T-P4S
36 000	53 000	36	107	214	105	316	642	68,5	100,6	130,2	•	0,17	XC7007-E-T-P4S
20 000	34 000	136	454	942	427	1 555	3 475	45,3	79,1	116,0	•	0,28	B7207-C-T-P4S
19 000	32 000	197	714	1 521	580	2 185	4 825	103,9	170,4	234,1	•	0,28	B7207-E-T-P4S
26 000	40 000	66	241	514	202	786	1 777	37,9	65,1	93,2	•	0,24	HCB7207-C-T-P4S
22 000	36 000	84	362	804	247	1 091	2 489	86,9	147,5	201,3	•	0,24	HCB7207-E-T-P4S

X-life ultra design

XCB7007-E2RSD-T-P4S-UL
XC7007-EDLR-T-P4S-UL

TX design

HCB7007-C-TX-P4S-UL
XC7007-EDLR-TX-P4S-UL

FAG Spindle Bearings

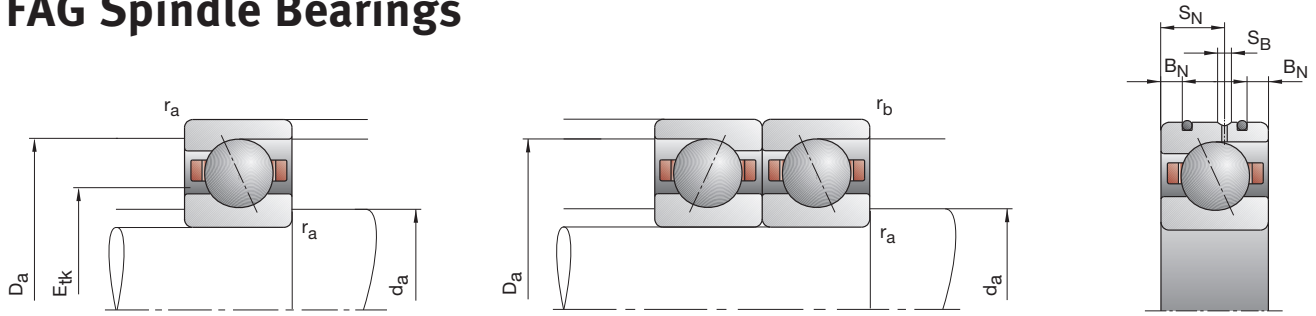

Bearing code	Dimensions					Abutment dimensions				DLR dimensions			Load rating		
	d	D	B	r _{smin}	r _{1smin}	d _a	D _a	r _a	r _b	B _N	S _N	S _B	E _{tk} nom.	C _{dyn}	C _{0stat}
FAG	mm													kN	
B71808-C-TPA-P4	40	52	7	0,30	0,10	43	49	0,3	0,1				44,5	4,80	4,55
B71808-E-TPA-P4	40	52	7	0,30	0,10	43	49	0,3	0,1				44,5	4,55	4,25
HCB71808-C-TPA-P4	40	52	7	0,30	0,10	43	49	0,3	0,1				44,5	3,35	3,15
HCB71808-E-TPA-P4	40	52	7	0,30	0,10	43	49	0,3	0,1				44,5	3,15	2,90
B71908-C-T-P4S	40	62	12	0,60	0,60	45	58,5	0,6	0,6				49,1	17,60	13,70
B71908-E-T-P4S	40	62	12	0,60	0,60	45	58,5	0,6	0,6				49,1	16,60	13,20
HCB71908-C-T-P4S	40	62	12	0,60	0,60	45	58,5	0,6	0,6	2,2	6,6	1,4	49,1	12,20	9,65
HCB71908-E-T-P4S	40	62	12	0,60	0,60	45	58,5	0,6	0,6	2,2	6,6	1,4	49,1	11,40	9,15
XCB71908-C-T-P4S	40	62	12	0,60	0,60	45	58,5	0,6	0,6	2,2	6,6	1,4	49,1	27,00	9,65
XCB71908-E-T-P4S	40	62	12	0,60	0,60	45	58,5	0,6	0,6	2,2	6,6	1,4	49,1	25,50	9,15
HS71908-C-T-P4S	40	62	12	0,60		45	58,5	0,6	0,6				49,3	7,20	6,95
HS71908-E-T-P4S	40	62	12	0,60		45	58,5	0,6	0,6				49,3	6,80	6,40
HC71908-C-T-P4S	40	62	12	0,60		45	58,5	0,6	0,6	2,2	6,6	1,4	49,3	5,00	4,80
HC71908-E-T-P4S	40	62	12	0,60		45	58,5	0,6	0,6	2,2	6,6	1,4	49,3	4,75	4,50
XC71908-C-T-P4S	40	62	12	0,60		45	58,5	0,6	0,6	2,2	6,6	1,4	49,3	11,20	4,80
XC71908-E-T-P4S	40	62	12	0,60		45	58,5	0,6	0,6	2,2	6,6	1,4	49,3	10,60	4,50
B7008-C-T-P4S	40	68	15	1,00	1,00	46	62	1,0	0,3				50,8	20,40	16,00
B7008-E-T-P4S	40	68	15	1,00	1,00	46	62	1,0	0,3				50,8	19,60	15,00
HCB7008-C-T-P4S	40	68	15	1,00	1,00	46	62	1,0	0,3	2,8	8,5	1,4	50,8	14,30	11,00
HCB7008-E-T-P4S	40	68	15	1,00	1,00	46	62	1,0	0,3	2,8	8,5	1,4	50,8	13,40	10,60
XCB7008-C-T-P4S	40	68	15	1,00	1,00	46	62	1,0	0,3	2,8	8,5	1,4	50,8	32,00	11,00
XCB7008-E-T-P4S	40	68	15	1,00	1,00	46	62	1,0	0,3	2,8	8,5	1,4	50,8	30,00	10,60
HS7008-C-T-P4S	40	68	15	1,00		46	62	1,0	0,3				52,0	10,00	9,30
HS7008-E-T-P4S	40	68	15	1,00		46	62	1,0	0,3				52,0	9,30	8,65
HC7008-C-T-P4S	40	68	15	1,00		46	62	1,0	0,3	2,8	8,5	1,4	52,0	6,80	6,55
HC7008-E-T-P4S	40	68	15	1,00		46	62	1,0	0,3	2,8	8,5	1,4	52,0	6,40	6,10
XC7008-C-T-P4S	40	68	15	1,00		46	62	1,0	0,3	2,8	8,5	1,4	52,0	15,30	6,55
XC7008-E-T-P4S	40	68	15	1,00		46	62	1,0	0,3	2,8	8,5	1,4	52,0	14,30	6,10
B7208-C-T-P4S	40	80	18	1,10	1,10	48	72	1,0	1,0				56,7	32,00	22,40
B7208-E-T-P4S	40	80	18	1,10	1,10	48	72	1,0	1,0				56,7	30,50	21,60
HCB7208-C-T-P4S	40	80	18	1,10	1,10	48	72	1,0	1,0				56,7	22,00	15,60
HCB7208-E-T-P4S	40	80	18	1,10	1,10	48	72	1,0	1,0				56,7	21,20	15,00

* options; • = possible, – = not possible

** see section Engineering, Speeds

*** see section Engineering, Deflection and Rigidity

Designation examples:

Sealed design

B7008-C-2RSD-T-P4S-UL

HSS7008-E-T-P4S-UL

Hybrid ceramic design

HC7008-E-T-P4S-UL

HCB71808-C-TPA-P4-UL

Direct Lube design

HCB7008-EDLR-T-P4S-UL

HC7008-EDLR-T-P4S-UL

B718..C/E, B719, B70, B72 HS719..C/E, HS70

C: Contact angle $\alpha = 15^\circ$
E: Contact angle $\alpha = 25^\circ$

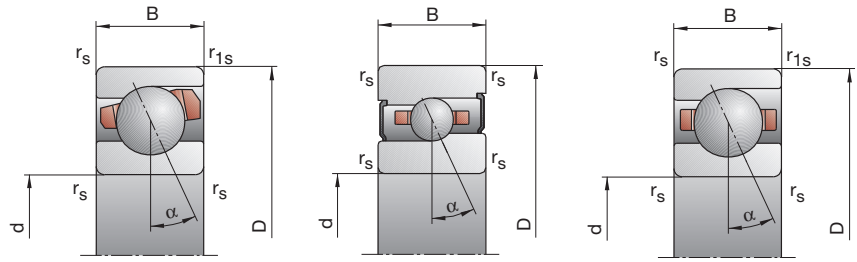

Attainable speed**		Preloading force F_V			Unloading force*** K_{aE}			Axial rigidity*** c_a			Sealed design*	Weight	Bearing code
Grease	Oil	L	M	H	L	M	H	L	M	H		kg	FAG
minimal		N						N/ μ m					
min^{-1}													
24 000	38 000	17	59	138	51	190	481	24,7	42,4	64,9	—	0,03	B71808-C-TPA-P4
22 000	36 000	17	75	199	48	220	604	50,8	88,2	129,8	—	0,03	B71808-E-TPA-P4
30 000	45 000	8	29	77	24	90	253	21,2	34,8	53,5	—	0,03	HCB71808-C-TPA-P4
26 000	40 000	16	47	112	46	138	334	56,9	84,0	115,9	—	0,03	HCB71808-E-TPA-P4
22 000	36 000	85	300	633	265	1019	2315	41,1	72,9	107,4	•	0,11	B71908-C-T-P4S
20 000	34 000	112	450	984	328	1366	3101	91,7	155,3	215,0	•	0,11	B71908-E-T-P4S
28 000	43 000	39	156	341	119	505	1170	33,9	59,8	86,1	•	0,09	HCB71908-C-T-P4S
24 000	38 000	76	222	519	224	666	1596	90,7	133,7	185,4	•	0,09	HCB71908-E-T-P4S
36 000	53 000	39	156	341	119	505	1170	33,9	59,8	86,1	•	0,09	XCB71908-C-T-P4S
30 000	45 000	76	222	519	224	666	1596	90,7	133,7	185,4	•	0,09	XCB71908-E-T-P4S
28 000	43 000	25	74	147	75	233	484	27,0	42,3	57,7	•	0,13	HS71908-C-T-P4S
24 000	38 000	40	120	239	115	352	715	66,9	99,9	130,0	•	0,13	HS71908-E-T-P4S
32 000	48 000	17	51	102	51	158	328	26,4	40,5	54,5	•	0,12	HC71908-C-T-P4S
30 000	43 000	28	83	166	81	244	496	67,0	98,7	127,8	•	0,12	HC71908-E-T-P4S
40 000	60 000	17	51	102	51	158	328	26,4	40,5	54,5	•	0,12	XC71908-C-T-P4S
36 000	53 000	28	83	166	81	244	496	67,0	98,7	127,8	•	0,12	XC71908-E-T-P4S
20 000	34 000	102	353	743	318	1201	2722	43,5	76,9	113,2	•	0,19	B7008-C-T-P4S
19 000	32 000	142	547	1180	417	1665	3728	99,2	165,8	228,5	•	0,19	B7008-E-T-P4S
26 000	40 000	48	187	406	146	607	1397	36,2	63,5	91,3	•	0,17	HCB7008-C-T-P4S
22 000	36 000	55	269	617	161	809	1900	80,3	142,5	196,1	•	0,17	HCB7008-E-T-P4S
34 000	50 000	48	187	406	146	607	1397	36,2	63,5	91,3	•	0,17	XCB7008-C-T-P4S
28 000	43 000	55	269	617	161	809	1900	80,3	142,5	196,1	•	0,17	XCB7008-E-T-P4S
26 000	40 000	34	101	201	102	318	665	30,3	47,5	65,2	•	0,22	HS7008-C-T-P4S
22 000	36 000	54	163	327	156	479	981	75,1	112,0	146,4	•	0,22	HS7008-E-T-P4S
30 000	45 000	23	70	139	69	217	448	29,6	45,6	61,2	•	0,20	HC7008-C-T-P4S
28 000	40 000	38	113	225	110	333	673	75,1	110,9	143,1	•	0,20	HC7008-E-T-P4S
38 000	56 000	23	70	139	69	217	448	29,6	45,6	61,2	•	0,20	XC7008-C-T-P4S
34 000	50 000	38	113	225	110	333	673	75,1	110,9	143,1	•	0,20	XC7008-E-T-P4S
18 000	30 000	176	584	1204	554	2007	4451	49,6	86,5	126,5	•	0,37	B7208-C-T-P4S
17 000	28 000	259	912	1925	764	2796	6112	114,2	185,5	253,8	•	0,37	B7208-E-T-P4S
24 000	38 000	89	314	662	273	1027	2296	42,1	71,5	102,0	•	0,33	HCB7208-C-T-P4S
20 000	34 000	118	477	1045	347	1441	3235	97,6	162,5	220,5	•	0,33	HCB7208-E-T-P4S

X-life ultra design

XCB7008-E-2RSD-T-P4S-UL
XC7008-EDLR-T-P4S-UL

TX design

HCB7008-C-TX-P4S-UL
XC7008-EDLR-TX-P4S-UL

FAG Spindle Bearings

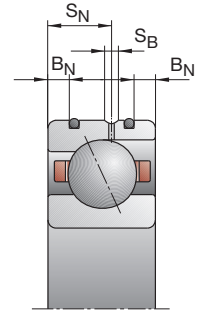
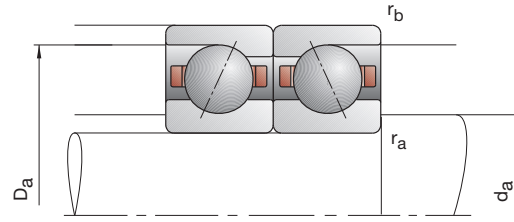
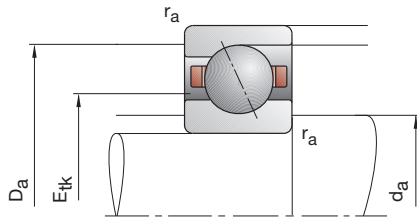

Bearing code	Dimensions					Abutment dimensions				DLR dimensions			Load rating			
	d	D	B	r _{smin}	r _{1smin}	d _a	D _a	r _a	r _b	B _N	S _N	S _B	E _{tk} nom.	C _{dyn}	C _{0stat}	
FAG	mm														kN	
B71809-C-TPA-P4	45	58	7	0,30	0,10	48	55,5	0,3	0,1				49,6	7,20	6,95	
B71809-E-TPA-P4	45	58	7	0,30	0,10	48	55,5	0,3	0,1				49,6	6,80	6,40	
HCB71809-C-TPA-P4	45	58	7	0,30	0,10	48	55,5	0,3	0,1				49,6	5,00	4,80	
HCB71809-E-TPA-P4	45	58	7	0,30	0,10	48	55,5	0,3	0,1				49,6	4,75	4,50	
B71909-C-T-P4S	45	68	12	0,60	0,60	50	63,5	0,6	0,6				54,4	18,60	15,60	
B71909-E-T-P4S	45	68	12	0,60	0,60	50	63,5	0,6	0,6				54,4	17,60	15,00	
HCB71909-C-T-P4S	45	68	12	0,60	0,60	50	63,5	0,6	0,6	2,2	6,6	1,4	54,4	12,90	10,80	
HCB71909-E-T-P4S	45	68	12	0,60	0,60	50	63,5	0,6	0,6	2,2	6,6	1,4	54,4	12,20	10,40	
XCB71909-C-T-P4S	45	68	12	0,60	0,60	50	63,5	0,6	0,6	2,2	6,6	1,4	54,4	29,00	10,80	
XCB71909-E-T-P4S	45	68	12	0,60	0,60	50	63,5	0,6	0,6	2,2	6,6	1,4	54,4	27,00	10,40	
HS71909-C-T-P4S	45	68	12	0,60		50	63,5	0,6	0,6				54,5	10,00	9,65	
HS71909-E-T-P4S	45	68	12	0,60		50	63,5	0,6	0,6				54,5	9,50	9,00	
HC71909-C-T-P4S	45	68	12	0,60		50	63,5	0,6	0,6	2,2	6,6	1,4	54,5	6,95	6,70	
HC71909-E-T-P4S	45	68	12	0,60		50	63,5	0,6	0,6	2,2	6,6	1,4	54,5	6,55	6,30	
XC71909-C-T-P4S	45	68	12	0,60		50	63,5	0,6	0,6	2,2	6,6	1,4	54,5	15,60	6,70	
XC71909-E-T-P4S	45	68	12	0,60		50	63,5	0,6	0,6	2,2	6,6	1,4	54,5	14,60	6,30	
B7009-C-T-P4S	45	75	16	1,00	1,00	51	69	1,0	0,3				56,2	27,50	21,20	
B7009-E-T-P4S	45	75	16	1,00	1,00	51	69	1,0	0,3				56,2	26,50	20,00	
HCB7009-C-T-P4S	45	75	16	1,00	1,00	51	69	1,0	0,3	3,4	9,3	1,4	56,2	19,00	14,60	
HCB7009-E-T-P4S	45	75	16	1,00	1,00	51	69	1,0	0,3	3,4	9,3	1,4	56,2	18,00	14,00	
XCB7009-C-T-P4S	45	75	16	1,00	1,00	51	69	1,0	0,3	3,4	9,3	1,4	56,2	42,50	14,60	
XCB7009-E-T-P4S	45	75	16	1,00	1,00	51	69	1,0	0,3	3,4	9,3	1,4	56,2	40,00	14,00	
HS7009-C-T-P4S	45	75	16	1,00		51	69	1,0	0,3				57,7	12,90	12,20	
HS7009-E-T-P4S	45	75	16	1,00		51	69	1,0	0,3				57,7	12,20	11,40	
HC7009-C-T-P4S	45	75	16	1,00		51	69	1,0	0,3	3,4	9,3	1,4	57,7	8,80	8,50	
HC7009-E-T-P4S	45	75	16	1,00		51	69	1,0	0,3	3,4	9,3	1,4	57,7	8,30	8,00	
XC7009-C-T-P4S	45	75	16	1,00		51	69	1,0	0,3	3,4	9,3	1,4	57,7	19,60	8,50	
XC7009-E-T-P4S	45	75	16	1,00		51	69	1,0	0,3	3,4	9,3	1,4	57,7	18,60	8,00	
B7209-C-T-P4S	45	85	19	1,10	1,10	52,5	78	1,0	1,0				61,8	33,50	24,50	
B7209-E-T-P4S	45	85	19	1,10	1,10	52,5	78	1,0	1,0				61,8	32,00	23,60	
HCB7209-C-T-P4S	45	85	19	1,10	1,10	52,5	78	1,0	1,0				61,8	23,20	12,20	
HCB7209-E-T-P4S	45	85	19	1,10	1,10	52,5	78	1,0	1,0				61,8	22,00	11,60	

- * options; • = possible, – = not possible
- ** see section Engineering, Speeds
- *** see section Engineering, Deflection and Rigidity

Designation examples:

Sealed design

B7009-C-2RSD-T-P4S-UL
HSS7009-E-T-P4S-UL

Hybrid ceramic design

HC7009-E-T-P4S-UL
HCB71809-C-TPA-P4-UL

Direct Lube design

HCB7009-EDLR-T-P4S-UL
HC7009-EDLR-T-P4S-UL

B718..C/E, B719, B70, B72 HS719..C/E, HS70

C: Contact angle $\alpha = 15^\circ$
E: Contact angle $\alpha = 25^\circ$

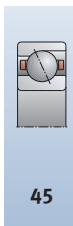
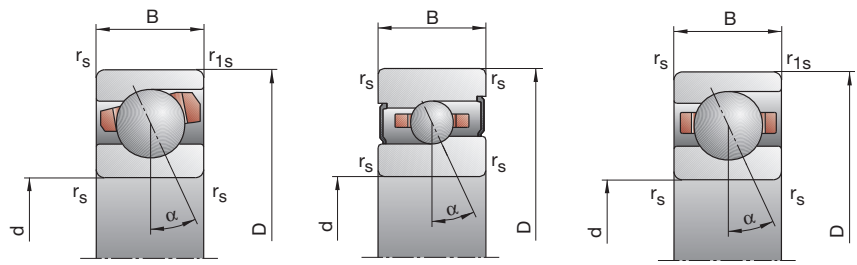

Attainable speed**		Preloading force F_V			Unloading force*** K_{aE}			Axial rigidity*** c_a			Sealed design*	Weight	Bearing code
Grease	Oil	L	M	H	L	M	H	L	M	H		kg	FAG
min ⁻¹	minimal	N						N/μm					
22000	36000	22	98	221	66	318	774	28,2	53,6	80,7	—	0,04	B71809-C-TPA-P4
19000	32000	35	133	328	100	391	999	69,0	113,1	162,6	—	0,04	B71809-E-TPA-P4
28000	43000	15	53	130	45	165	431	27,5	45,3	68,2	—	0,04	HCB71809-C-TPA-P4
24000	38000	24	85	193	69	249	580	68,6	107,9	147,7	—	0,04	HCB71809-E-TPA-P4
19000	32000	89	315	667	276	1064	2425	44,4	78,7	116,0	•	0,13	B71909-C-T-P4S
18000	30000	116	473	1038	339	1433	3261	99,2	168,8	233,6	•	0,13	B71909-E-T-P4S
24000	38000	41	164	360	124	529	1229	36,6	64,8	93,3	•	0,11	HCB71909-C-T-P4S
22000	36000	79	230	541	232	689	1659	98,2	144,8	200,8	•	0,11	HCB71909-E-T-P4S
32000	48000	41	164	360	124	529	1229	36,6	64,8	93,3	•	0,11	XCB71909-C-T-P4S
28000	43000	79	230	541	232	689	1659	98,2	144,8	200,8	•	0,11	XCB71909-E-T-P4S
26000	38000	34	103	205	102	323	677	31,0	48,8	67,1	•	0,14	HS71909-C-T-P4S
22000	36000	55	166	331	159	487	992	77,5	115,4	150,5	•	0,14	HS71909-E-T-P4S
28000	43000	24	71	142	72	220	457	30,8	46,9	63,1	•	0,13	HC71909-C-T-P4S
26000	38000	38	115	230	110	339	688	77,0	114,4	147,8	•	0,13	HC71909-E-T-P4S
38000	56000	24	71	142	72	220	457	30,8	46,9	63,1	•	0,13	XC71909-C-T-P4S
32000	48000	38	115	230	110	339	688	77,0	114,4	147,8	•	0,13	XC71909-E-T-P4S
18000	30000	145	490	1019	453	1669	3734	50,2	87,8	128,6	•	0,23	B7009-C-T-P4S
17000	28000	209	768	1638	614	2344	5176	115,5	190,0	260,6	•	0,23	B7009-E-T-P4S
24000	38000	72	264	562	220	858	1935	42,5	73,0	104,2	•	0,20	HCB7009-C-T-P4S
20000	34000	90	393	876	264	1182	2706	97,0	165,3	225,7	•	0,20	HCB7009-E-T-P4S
30000	45000	72	264	562	220	858	1935	42,5	73,0	104,2	•	0,20	XCB7009-C-T-P4S
26000	40000	90	393	876	264	1182	2706	97,0	165,3	225,7	•	0,20	XCB7009-E-T-P4S
26000	38000	44	131	263	131	412	870	34,3	54,2	74,9	•	0,27	HS7009-C-T-P4S
20000	34000	71	214	428	204	628	1283	85,7	128,1	167,4	•	0,27	HS7009-E-T-P4S
26000	40000	30	91	182	89	282	586	33,4	52,1	70,2	•	0,26	HC7009-C-T-P4S
26000	38000	49	147	294	142	431	876	85,5	126,1	163,3	•	0,26	HC7009-E-T-P4S
34000	50000	30	91	182	89	282	586	33,4	52,1	70,2	•	0,26	XC7009-C-T-P4S
30000	45000	49	147	294	142	431	876	85,5	126,1	163,3	•	0,26	XC7009-E-T-P4S
17000	28000	184	607	1252	578	2078	4609	52,7	91,5	133,6	•	0,41	B7209-C-T-P4S
15000	24000	270	955	2016	796	2916	6388	121,6	197,3	270,0	•	0,41	B7209-E-T-P4S
22000	36000	93	329	694	285	1074	2400	44,8	76,1	108,3	•	0,34	HCB7209-C-T-P4S
18000	30000	121	493	1083	356	1487	3346	103,4	172,2	233,8	•	0,34	HCB7209-E-T-P4S

X-life ultra design

XCB7009-E-2RSD-T-P4S-UL
XC7009-EDLR-T-P4S-UL

TX design

HCB7009-C-TX-P4S-UL
XC7009-EDLR-TX-P4S-UL

FAG Spindle Bearings

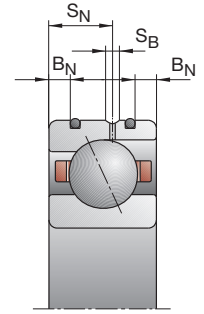
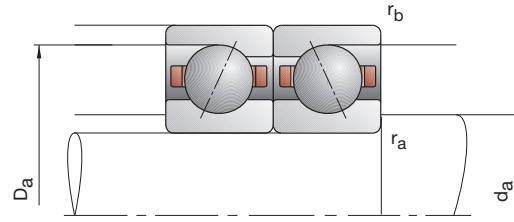
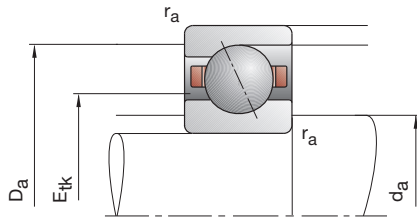

Bearing code	Dimensions					Abutment dimensions				DLR dimensions			Load rating			
	d	D	B	r _{smin}	r _{1smin}	d _a	D _a	r _a	r _b	B _N	S _N	S _B	E _{tk} nom.	C _{dyn}	C _{0stat}	
FAG	mm														kN	
B71810-C-TPA-P4	50	65	7	0,30	0,10	54	61,5	0,3	0,1				55,6	7,35	7,35	
B71810-E-TPA-P4	50	65	7	0,30	0,10	54	61,5	0,3	0,1				55,6	6,95	6,80	
HCB71810-C-TPA-P4	50	65	7	0,30	0,10	54	61,5	0,3	0,1				55,6	5,10	5,10	
HCB71810-E-TPA-P4	50	65	7	0,30	0,10	54	61,5	0,3	0,1				55,6	4,80	4,75	
B71910-C-T-P4S	50	72	12	0,60	0,60	55	67,5	0,6	0,6				58,9	19,00	16,60	
B71910-E-T-P4S	50	72	12	0,60	0,60	55	67,5	0,6	0,6				58,9	18,00	15,60	
HCB71910-C-T-P4S	50	72	12	0,60	0,60	55	67,5	0,6	0,6	2,2	6,6	1,4	58,9	13,20	11,60	
HCB71910-E-T-P4S	50	72	12	0,60	0,60	55	67,5	0,6	0,6	2,2	6,6	1,4	58,9	12,20	11,00	
XCB71910-C-T-P4S	50	72	12	0,60	0,60	55	67,5	0,6	0,6	2,2	6,6	1,4	58,9	29,00	11,60	
XCB71910-E-T-P4S	50	72	12	0,60	0,60	55	67,5	0,6	0,6	2,2	6,6	1,4	58,9	27,00	11,00	
HS71910-C-T-P4S	50	72	12	0,60		55	67,5	0,6	0,6				59,0	10,40	10,20	
HS71910-E-T-P4S	50	72	12	0,60		55	67,5	0,6	0,6				59,0	9,80	9,65	
HC71910-C-T-P4S	50	72	12	0,60		55	67,5	0,6	0,6	2,2	6,6	1,4	59,0	7,10	7,20	
HC71910-E-T-P4S	50	72	12	0,60		55	67,5	0,6	0,6	2,2	6,6	1,4	59,0	6,70	6,70	
XC71910-C-T-P4S	50	72	12	0,60		55	67,5	0,6	0,6	2,2	6,6	1,4	59,0	16,00	7,20	
XC71910-E-T-P4S	50	72	12	0,60		55	67,5	0,6	0,6	2,2	6,6	1,4	59,0	15,00	6,70	
B7010-C-T-P4S	50	80	16	1,00	1,00	56	74	1,0	0,3				61,2	28,50	22,80	
B7010-E-T-P4S	50	80	16	1,00	1,00	56	74	1,0	0,3				61,2	27,00	21,60	
HCB7010-C-T-P4S	50	80	16	1,00	1,00	56	74	1,0	0,3	3,4	9,3	1,4	61,2	19,60	16,00	
HCB7010-E-T-P4S	50	80	16	1,00	1,00	56	74	1,0	0,3	3,4	9,3	1,4	61,2	18,60	15,30	
XCB7010-C-T-P4S	50	80	16	1,00	1,00	56	74	1,0	0,3	3,4	9,3	1,4	61,2	44,00	16,00	
XCB7010-E-T-P4S	50	80	16	1,00	1,00	56	74	1,0	0,3	3,4	9,3	1,4	61,2	41,50	15,30	
HS7010-C-T-P4S	50	80	16	1,00		56	74	1,0	0,3				62,7	13,40	13,20	
HS7010-E-T-P4S	50	80	16	1,00		56	74	1,0	0,3				62,7	12,50	12,20	
HC7010-C-T-P4S	50	80	16	1,00		56	74	1,0	0,3	3,4	9,3	1,4	62,7	9,15	9,15	
HC7010-E-T-P4S	50	80	16	1,00		56	74	1,0	0,3	3,4	9,3	1,4	62,7	8,65	8,50	
XC7010-C-T-P4S	50	80	16	1,00		56	74	1,0	0,3	3,4	9,3	1,4	62,7	20,40	9,15	
XC7010-E-T-P4S	50	80	16	1,00		56	74	1,0	0,3	3,4	9,3	1,4	62,7	19,30	8,50	
B7210-C-T-P4S	50	90	20	1,10	1,10	57	83	1,0	1,0				66,2	43,00	31,50	
B7210-E-T-P4S	50	90	20	1,10	1,10	57	83	1,0	1,0				66,2	40,50	30,50	
HCB7210-C-T-P4S	50	90	20	1,10	1,10	57	83	1,0	1,0				66,2	30,00	22,00	
HCB7210-E-T-P4S	50	90	20	1,10	1,10	57	83	1,0	1,0				66,2	28,00	21,20	

- * options; • = possible, – = not possible
- ** see section Engineering, Speeds
- *** see section Engineering, Deflection and Rigidity

Designation examples:

Sealed design

B7010-C-2RSD-T-P4S-UL
HSS7010-E-T-P4S-UL

Hybrid ceramic design

HC7010-E-T-P4S-UL
HCB71810-C-TPA-P4-UL

Direct Lube design

HCB7010-EDLR-T-P4S-UL
HC7010-EDLR-T-P4S-UL

B718..C/E, B719, B70, B72 HS719..C/E, HS70

C: Contact angle $\alpha = 15^\circ$

E: Contact angle $\alpha = 25^\circ$

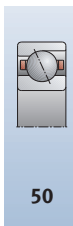
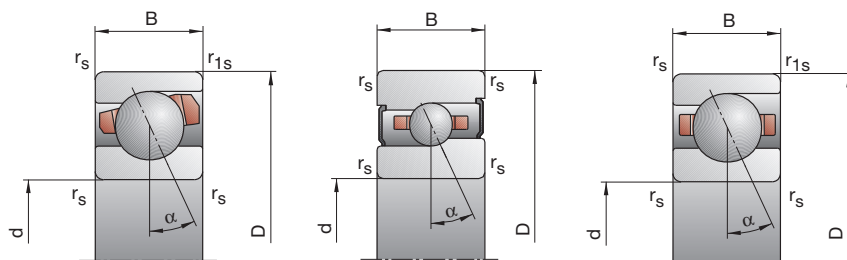

Attainable speed**		Preloading force			Unloading force***			Axial rigidity***			Sealed design*	Weight	Bearing code
Grease	Oil	L	M	H	L	M	H	L	M	H			
min ⁻¹	minimal	N						N/μm			kg	FAG	
19000	32000	21	99	224	62	320	780	28,5	55,9	84,0	—	0,05	B71810-C-TPA-P4
17000	28000	34	133	332	97	390	1011	71,4	117,9	170,2	—	0,05	B71810-E-TPA-P4
24000	38000	14	52	129	41	162	425	27,5	46,9	70,4	—	0,05	HCB71810-C-TPA-P4
20000	34000	25	86	195	72	252	585	72,9	113,3	154,7	—	0,05	HCB71810-E-TPA-P4
18000	30000	90	321	679	279	1081	2459	46,0	81,4	119,7	•	0,13	B71910-C-T-P4S
16000	26000	118	482	1059	345	1458	3322	103,1	175,1	242,3	•	0,13	B71910-E-T-P4S
22000	36000	41	166	366	124	534	1246	37,8	66,9	96,4	•	0,11	HCB71910-C-T-P4S
20000	34000	79	232	549	232	694	1681	101,4	149,7	208,0	•	0,11	HCB71910-E-T-P4S
30000	43000	41	166	366	124	534	1246	37,8	66,9	96,4	•	0,11	XCB71910-C-T-P4S
26000	40000	79	232	549	232	694	1681	101,4	149,7	208,0	•	0,11	XCB71910-E-T-P4S
24000	36000	35	105	209	105	329	687	32,8	51,4	70,2	•	0,15	HS71910-C-T-P4S
20000	34000	58	173	345	167	507	1033	82,4	122,5	159,7	•	0,15	HS71910-E-T-P4S
26000	40000	24	72	145	71	222	465	31,8	49,1	66,2	•	0,14	HC71910-C-T-P4S
24000	36000	39	117	235	113	344	702	81,5	120,3	155,8	•	0,14	HC71910-E-T-P4S
34000	50000	24	72	145	71	222	465	31,8	49,1	66,2	•	0,14	XC71910-C-T-P4S
30000	45000	39	117	235	113	344	702	81,5	120,3	155,8	•	0,14	XC71910-E-T-P4S
17000	28000	150	507	1054	468	1722	3850	52,7	92,0	134,7	•	0,25	B7010-C-T-P4S
15000	24000	211	779	1663	619	2372	5240	120,4	198,1	271,5	•	0,25	B7010-E-T-P4S
22000	36000	74	275	586	226	892	2014	44,6	76,9	109,7	•	0,21	HCB7010-C-T-P4S
18000	30000	89	397	889	261	1192	2741	100,5	172,3	235,5	•	0,21	HCB7010-E-T-P4S
28000	43000	74	275	586	226	892	2014	44,6	76,9	109,7	•	0,21	XCB7010-C-T-P4S
24000	38000	89	397	889	261	1192	2741	100,5	172,3	235,5	•	0,21	XCB7010-E-T-P4S
22000	36000	46	137	273	137	430	900	36,7	57,7	79,4	•	0,29	HS7010-C-T-P4S
18000	30000	74	222	444	212	650	1329	91,2	136,2	178,0	•	0,29	HS7010-E-T-P4S
24000	38000	32	95	190	95	294	610	36,0	55,4	74,7	•	0,27	HC7010-C-T-P4S
24000	36000	51	154	308	148	451	917	91,3	134,6	174,3	•	0,27	HC7010-E-T-P4S
32000	48000	32	95	190	95	294	610	36,0	55,4	74,7	•	0,27	XC7010-C-T-P4S
28000	43000	51	154	308	148	451	917	91,3	134,6	174,3	•	0,27	XC7010-E-T-P4S
16000	26000	242	792	1631	761	2708	6004	60,4	104,4	152,5	•	0,46	B7210-C-T-P4S
14000	22000	355	1230	2583	1045	3757	8185	139,2	224,3	306,1	•	0,46	B7210-E-T-P4S
20000	34000	123	425	893	377	1384	3080	51,4	86,5	122,8	•	0,39	HCB7210-C-T-P4S
17000	28000	169	657	1425	498	1985	4409	121,0	198,4	268,1	•	0,39	HCB7210-E-T-P4S

X-life ultra design

XCB7010-E-2RSD-T-P4S-UL
XC7010-EDLR-T-P4S-UL

TX design

HCB7010-C-TX-P4S-UL
XC7010-EDLR-TX-P4S-UL

FAG Spindle Bearings

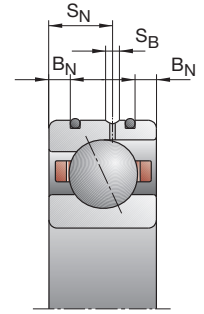
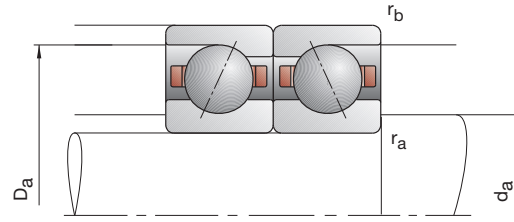
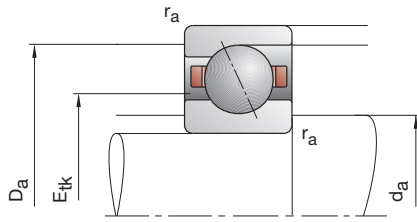

Bearing code	Dimensions					Abutment dimensions				DLR dimensions			Load rating			
	d	D	B	r _{smin}	r _{1smin}	d _a	D _a	r _a	r _b	B _N	S _N	S _B	E _{tk} nom.	C _{dyn}	C _{0stat}	
FAG	mm														kN	
B71811-C-TPA-P4	55	72	9	0,30	0,10	59	68,5	0,3	0,1				61,2	10,20	10,20	
B71811-E-TPA-P4	55	72	9	0,30	0,10	59	68,5	0,3	0,1				61,2	9,65	9,50	
HCB71811-C-TPA-P4	55	72	9	0,30	0,10	59	68,5	0,3	0,1				61,2	7,10	7,20	
HCB71811-E-TPA-P4	55	72	9	0,30	0,10	59	68,5	0,3	0,1				61,2	6,70	6,70	
B71911-C-T-P4S	55	80	13	1,00	1,00	60	75,5	0,6	0,6				65,1	22,80	20,40	
B71911-E-T-P4S	55	80	13	1,00	1,00	60	75,5	0,6	0,6				65,1	21,60	19,30	
HCB71911-C-T-P4S	55	80	13	1,00	1,00	60	75,5	0,6	0,6	2,8	7,2	1,4	65,1	16,00	14,30	
HCB71911-E-T-P4S	55	80	13	1,00	1,00	60	75,5	0,6	0,6	2,8	7,2	1,4	65,1	15,00	13,40	
XCB71911-C-T-P4S	55	80	13	1,00	1,00	60	75,5	0,6	0,6	2,8	7,2	1,4	65,1	35,50	14,30	
XCB71911-E-T-P4S	55	80	13	1,00	1,00	60	75,5	0,6	0,6	2,8	7,2	1,4	65,1	33,50	13,40	
HS71911-C-T-P4S	55	80	13	1,00		60	75,5	0,6	0,6				65,2	13,40	13,70	
HS71911-E-T-P4S	55	80	13	1,00		60	75,5	0,6	0,6				65,2	12,70	12,70	
HC71911-C-T-P4S	55	80	13	1,00		60	75,5	0,6	0,6	2,8	7,2	1,4	65,2	9,30	9,50	
HC71911-E-T-P4S	55	80	13	1,00		60	75,5	0,6	0,6	2,8	7,2	1,4	65,2	8,80	8,80	
XC71911-C-T-P4S	55	80	13	1,00		60	75,5	0,6	0,6	2,8	7,2	1,4	65,2	20,80	9,50	
XC71911-E-T-P4S	55	80	13	1,00		60	75,5	0,6	0,6	2,8	7,2	1,4	65,2	19,60	8,80	
B7011-C-T-P4S	55	90	18	1,10	1,10	62	83	1,0	0,6				68,1	38,00	31,00	
B7011-E-T-P4S	55	90	18	1,10	1,10	62	83	1,0	0,6				68,1	36,00	29,00	
HCB7011-C-T-P4S	55	90	18	1,10	1,10	62	83	1,0	0,6	4,3	9,7	1,4	68,1	26,00	21,60	
HCB7011-E-T-P4S	55	90	18	1,10	1,10	62	83	1,0	0,6	4,3	9,7	1,4	68,1	25,00	20,40	
XCB7011-C-T-P4S	55	90	18	1,10	1,10	62	83	1,0	0,6	4,3	9,7	1,4	68,1	58,50	21,60	
XCB7011-E-T-P4S	55	90	18	1,10	1,10	62	83	1,0	0,6	4,3	9,7	1,4	68,1	56,00	20,40	
HS7011-C-T-P4S	55	90	18	1,10		62	83	1,0	0,6				69,7	18,60	19,00	
HS7011-E-T-P4S	55	90	18	1,10		62	83	1,0	0,6				69,7	17,60	17,60	
HC7011-C-T-P4S	55	90	18	1,10		62	83	1,0	0,6	4,3	9,7	1,4	69,7	12,90	13,20	
HC7011-E-T-P4S	55	90	18	1,10		62	83	1,0	0,6	4,3	9,7	1,4	69,7	12,20	12,20	
XC7011-C-T-P4S	55	90	18	1,10		62	83	1,0	0,6	4,3	9,7	1,4	69,7	29,00	13,20	
XC7011-E-T-P4S	55	90	18	1,10		62	83	1,0	0,6	4,3	9,7	1,4	69,7	27,00	12,20	
B7211-C-T-P4S	55	100	21	1,50	1,50	63	92	1,5	1,5				73,7	46,50	37,50	
B7211-E-T-P4S	55	100	21	1,50	1,50	63	92	1,5	1,5				73,7	44,00	35,50	
HCB7211-C-T-P4S	55	100	21	1,50	1,50	63	92	1,5	1,5				73,7	32,00	18,30	
HCB7211-E-T-P4S	55	100	21	1,50	1,50	63	92	1,5	1,5				73,7	30,50	17,60	

- * options; • = possible, – = not possible
- ** see section Engineering, Speeds
- *** see section Engineering, Deflection and Rigidity

Designation examples:

Sealed design

B7011-C-2RSD-T-P4S-UL
HSS7011-E-T-P4S-UL

Hybrid ceramic design

HC7011-E-T-P4S-UL
HCB71811-C-TPA-P4-UL

Direct Lube design

HCB7011-EDLR-T-P4S-UL
HC7011-EDLR-T-P4S-UL

B718..C/E, B719, B70, B72 HS719..C/E, HS70

C: Contact angle $\alpha = 15^\circ$
E: Contact angle $\alpha = 25^\circ$

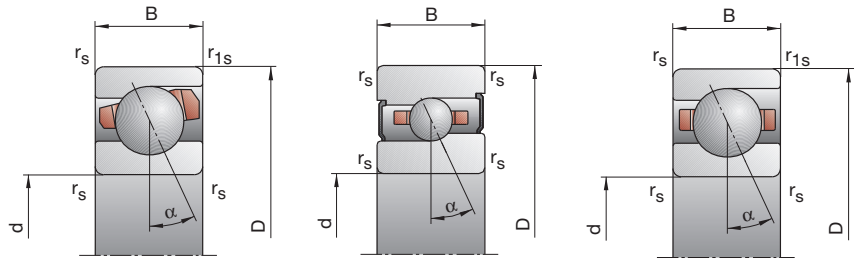

Attainable speed**		Preloading force F_V			Unloading force*** K_{aE}			Axial rigidity*** c_a			Sealed design*	Weight	Bearing code
Grease	Oil	L	M	H	L	M	H	L	M	H		kg	FAG
min ⁻¹		N						N/μm					
17000	28000	35	147	326	105	477	1139	35,9	66,8	99,7	—	0,08	B71811-C-TPA-P4
16000	26000	57	206	491	163	607	1497	88,4	142,6	202,4	—	0,08	B71811-E-TPA-P4
22000	36000	17	82	194	50	257	645	30,5	57,4	84,9	—	0,08	HCB71811-C-TPA-P4
19000	32000	30	98	269	86	286	805	80,0	122,1	178,6	—	0,08	HCB71811-E-TPA-P4
16000	26000	112	391	825	347	1317	2985	51,2	90,0	131,9	•	0,18	B71911-C-T-P4S
15000	24000	149	592	1287	436	1791	4036	115,5	194,2	267,4	•	0,18	B71911-E-T-P4S
20000	34000	51	204	444	154	656	1510	42,1	74,2	106,2	•	0,15	HCB71911-C-T-P4S
18000	30000	58	298	693	170	893	2125	94,2	168,8	233,2	•	0,15	HCB71911-E-T-P4S
26000	40000	51	204	444	154	656	1510	42,1	74,2	106,2	•	0,15	XCB71911-C-T-P4S
24000	38000	58	298	693	170	893	2125	94,2	168,8	233,2	•	0,15	XCB71911-E-T-P4S
22000	34000	46	139	279	137	436	919	37,5	59,4	81,8	•	0,20	HS71911-C-T-P4S
18000	30000	75	225	451	215	659	1349	93,9	140,1	183,1	•	0,20	HS71911-E-T-P4S
24000	38000	32	96	193	95	296	619	36,8	56,8	76,7	•	0,19	HC71911-C-T-P4S
22000	34000	52	156	313	150	457	931	93,6	138,5	179,3	•	0,19	HC71911-E-T-P4S
32000	48000	32	96	193	95	296	619	36,8	56,8	76,7	•	0,19	XC71911-C-T-P4S
26000	40000	52	156	313	150	457	931	93,6	138,5	179,3	•	0,19	XC71911-E-T-P4S
15000	24000	207	687	1424	647	2336	5203	61,9	107,2	156,5	•	0,37	B7011-C-T-P4S
14000	22000	298	1066	2257	876	3243	7117	142,4	231,6	316,4	•	0,37	B7011-E-T-P4S
19000	32000	104	373	789	317	1212	2713	52,6	89,6	127,3	•	0,32	HCB7011-C-T-P4S
17000	28000	134	553	1219	394	1664	3754	121,6	202,9	275,4	•	0,32	HCB7011-E-T-P4S
26000	40000	104	373	789	317	1212	2713	52,6	89,6	127,3	•	0,32	XCB7011-C-T-P4S
22000	36000	134	553	1219	394	1664	3754	121,6	202,9	275,4	•	0,32	XCB7011-E-T-P4S
20000	32000	64	192	383	191	603	1264	42,6	67,2	92,4	•	0,43	HS7011-C-T-P4S
17000	28000	105	315	630	301	922	1883	106,6	159,2	207,9	•	0,43	HS7011-E-T-P4S
22000	36000	45	134	268	134	415	861	42,1	64,7	87,1	•	0,40	HC7011-C-T-P4S
20000	32000	73	219	437	211	643	1303	106,7	157,8	203,9	•	0,40	HC7011-E-T-P4S
28000	43000	45	134	268	134	415	861	42,1	64,7	87,1	•	0,40	XC7011-C-T-P4S
24000	38000	73	219	437	211	643	1303	106,7	157,8	203,9	•	0,40	XC7011-E-T-P4S
14000	22000	261	849	1750	816	2885	6395	67,3	115,6	168,4	•	0,61	B7211-C-T-P4S
13000	20000	381	1331	2797	1120	4055	8833	155,5	250,7	341,7	•	0,61	B7211-E-T-P4S
18000	30000	134	466	979	410	1513	3363	57,7	97,0	137,5	•	0,51	HCB7211-C-T-P4S
15000	24000	178	702	1527	524	2111	4710	134,4	220,8	298,5	•	0,51	HCB7211-E-T-P4S

X-life ultra design

XCB7011-E-2RSD-T-P4S-UL
XC7011-EDLR-T-P4S-UL

TX design

HCB7011-C-TX-P4S-UL
XC7011-EDLR-TX-P4S-UL

FAG Spindle Bearings

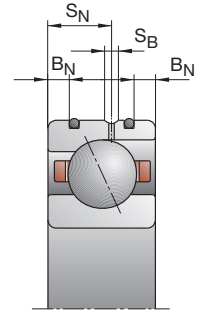
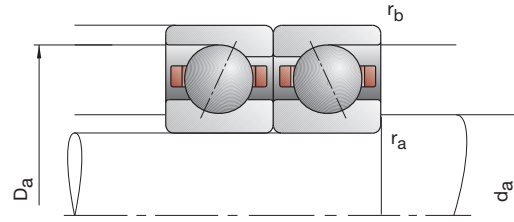
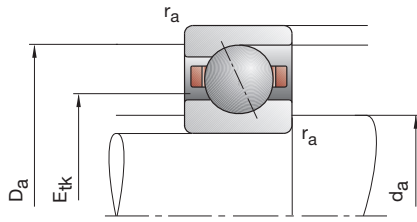

Bearing code	Dimensions					Abutment dimensions				DLR dimensions			Load rating		
	d	D	B	r _{smin}	r _{1smin}	d _a	D _a	r _a	r _b	B _N	S _N	S _B	E _{tk} nom.	C _{dyn}	C _{0stat}
FAG	mm														
B71812-C-TPA-P4	60	78	10	0,30	0,10	63	74,5	0,3	0,1				66,3	13,20	13,20
B71812-E-TPA-P4	60	78	10	0,30	0,10	63	74,5	0,3	0,1				66,3	12,20	12,20
HCB71812-C-TPA-P4	60	78	10	0,30	0,10	63	74,5	0,3	0,1				66,3	9,00	9,15
HCB71812-E-TPA-P4	60	78	10	0,30	0,10	63	74,5	0,3	0,1				66,3	8,50	8,50
B71912-C-T-P4S	60	85	13	1,00	1,00	65	80,5	0,6	0,6				70,1	24,00	22,80
B71912-E-T-P4S	60	85	13	1,00	1,00	65	80,5	0,6	0,6				70,1	22,80	21,60
HCB71912-C-T-P4S	60	85	13	1,00	1,00	65	80,5	0,6	0,6	2,8	7,2	1,4	70,1	16,60	16,00
HCB71912-E-T-P4S	60	85	13	1,00	1,00	65	80,5	0,6	0,6	2,8	7,2	1,4	70,1	15,60	15,00
XCB71912-C-T-P4S	60	85	13	1,00	1,00	65	80,5	0,6	0,6	2,8	7,2	1,4	70,1	37,50	16,00
XCB71912-E-T-P4S	60	85	13	1,00	1,00	65	80,5	0,6	0,6	2,8	7,2	1,4	70,1	34,50	15,00
HS71912-C-T-P4S	60	85	13	1,00		65	80,5	0,6	0,6				70,2	14,00	14,60
HS71912-E-T-P4S	60	85	13	1,00		65	80,5	0,6	0,6				70,2	13,20	13,40
HC71912-C-T-P4S	60	85	13	1,00		65	80,5	0,6	0,6	2,8	7,2	1,4	70,2	9,65	10,00
HC71912-E-T-P4S	60	85	13	1,00		65	80,5	0,6	0,6	2,8	7,2	1,4	70,2	9,00	9,50
XC71912-C-T-P4S	60	85	13	1,00		65	80,5	0,6	0,6	2,8	7,2	1,4	70,2	21,60	10,00
XC71912-E-T-P4S	60	85	13	1,00		65	80,5	0,6	0,6	2,8	7,2	1,4	70,2	20,00	9,50
B7012-C-T-P4S	60	95	18	1,10	1,10	67	88	1,0	0,6				73,1	39,00	33,50
B7012-E-T-P4S	60	95	18	1,10	1,10	67	88	1,0	0,6				73,1	36,50	31,50
HCB7012-C-T-P4S	60	95	18	1,10	1,10	67	88	1,0	0,6	4,3	9,7	1,4	73,1	27,00	23,20
HCB7012-E-T-P4S	60	95	18	1,10	1,10	67	88	1,0	0,6	4,3	9,7	1,4	73,1	25,50	22,00
XCB7012-C-T-P4S	60	95	18	1,10	1,10	67	88	1,0	0,6	4,3	9,7	1,4	73,1	60,00	23,20
XCB7012-E-T-P4S	60	95	18	1,10	1,10	67	88	1,0	0,6	4,3	9,7	1,4	73,1	57,00	22,00
HS7012-C-T-P4S	60	95	18	1,10		67	88	1,0	0,6				74,7	19,30	20,00
HS7012-E-T-P4S	60	95	18	1,10		67	88	1,0	0,6				74,7	18,30	19,00
HC7012-C-T-P4S	60	95	18	1,10		67	88	1,0	0,6	4,3	9,7	1,4	74,7	13,40	14,00
HC7012-E-T-P4S	60	95	18	1,10		67	88	1,0	0,6	4,3	9,7	1,4	74,7	12,70	13,20
XC7012-C-T-P4S	60	95	18	1,10		67	88	1,0	0,6	4,3	9,7	1,4	74,7	30,00	14,00
XC7012-E-T-P4S	60	95	18	1,10		67	88	1,0	0,6	4,3	9,7	1,4	74,7	28,50	13,20
B7212-C-T-P4S	60	110	22	1,50	1,50	69,5	101,5	1,5	1,5				81,2	55,00	44,00
B7212-E-T-P4S	60	110	22	1,50	1,50	69,5	101,5	1,5	1,5				81,2	52,00	42,50
HCB7212-C-T-P4S	60	110	22	1,50	1,50	69,5	101,5	1,5	1,5				81,2	38,00	30,50
HCB7212-E-T-P4S	60	110	22	1,50	1,50	69,5	101,5	1,5	1,5				81,2	36,00	29,00

- * options; • = possible, – = not possible
- ** see section Engineering, Speeds
- *** see section Engineering, Deflection and Rigidity

Designation examples:

Sealed design

B7012-C-2RSD-T-P4S-UL
HSS7012-E-T-P4S-UL

Hybrid ceramic design

HC7012-E-T-P4S-UL
HCB71812-C-TPA-P4-UL

Direct Lube design

HCB7012-EDLR-T-P4S-UL
HC7012-EDLR-T-P4S-UL

B718..C/E, B719, B70, B72 HS719..C/E, HS70

C: Contact angle $\alpha = 15^\circ$
E: Contact angle $\alpha = 25^\circ$

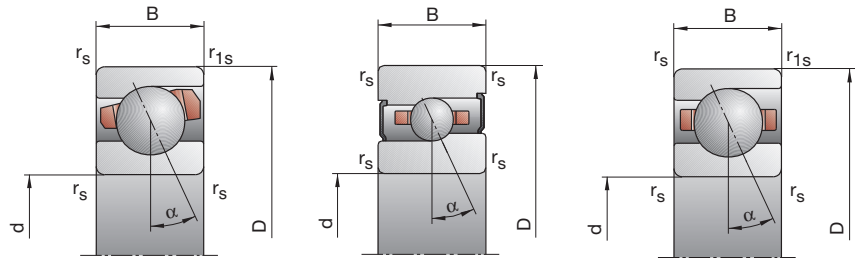

Attainable speed**		Preloading force F_V			Unloading force*** K_{aE}			Axial rigidity*** c_a			Sealed design*	Weight	Bearing code
Grease	Oil	L	M	H	L	M	H	L	M	H		kg	FAG
min ⁻¹	minimal	N						N/μm					
16 000	26 000	51	200	435	153	654	1 530	41,0	75,1	111,3	—	0,10	B71812-C-TPA-P4
14 000	22 000	80	280	649	229	826	1 985	99,6	159,2	223,9	—	0,10	B71812-E-TPA-P4
20 000	34 000	24	112	258	71	352	860	34,6	64,3	94,4	—	0,10	HCB71812-C-TPA-P4
17 000	28 000	41	145	370	118	424	1 111	89,5	140,4	200,4	—	0,10	HCB71812-E-TPA-P4
15 000	24 000	117	410	866	362	1 376	3 119	55,0	96,5	141,2	•	0,19	B71912-C-T-P4S
14 000	22 000	156	622	1 353	455	1 879	4 234	124,4	209,2	287,9	•	0,19	B71912-E-T-P4S
19 000	32 000	54	215	470	163	690	1 590	45,5	79,9	114,3	•	0,16	HCB71912-C-T-P4S
17 000	28 000	57	302	707	167	903	2 162	99,4	179,6	248,3	•	0,16	HCB71912-E-T-P4S
26 000	40 000	54	215	470	163	690	1 590	45,5	79,9	114,3	•	0,16	XCB71912-C-T-P4S
22 000	36 000	57	302	707	167	903	2 162	99,4	179,6	248,3	•	0,16	XCB71912-E-T-P4S
20 000	32 000	48	145	289	143	454	949	39,8	62,8	86,2	•	0,21	HS71912-C-T-P4S
17 000	28 000	78	235	469	224	688	1 401	99,7	148,7	193,8	•	0,21	HS71912-E-T-P4S
22 000	36 000	34	101	201	101	312	643	39,4	60,5	81,1	•	0,19	HC71912-C-T-P4S
20 000	32 000	53	160	320	153	468	951	98,7	146,0	188,8	•	0,19	HC71912-E-T-P4S
28 000	43 000	34	101	201	101	312	643	39,4	60,5	81,1	•	0,19	XC71912-C-T-P4S
24 000	38 000	53	160	320	153	468	951	98,7	146,0	188,8	•	0,19	XC71912-E-T-P4S
14 000	22 000	211	704	1 459	658	2 387	5 310	64,5	111,7	162,8	•	0,40	B7012-C-T-P4S
13 000	20 000	299	1 075	2 281	878	3 263	7 173	147,9	240,4	328,4	•	0,40	B7012-E-T-P4S
18 000	30 000	105	378	801	320	1 224	2 743	54,7	93,0	132,0	•	0,34	HCB7012-C-T-P4S
15 000	24 000	137	572	1 263	402	1 720	3 885	127,0	213,0	289,0	•	0,34	HCB7012-E-T-P4S
24 000	38 000	105	378	801	320	1 224	2 743	54,7	93,0	132,0	•	0,34	XCB7012-C-T-P4S
20 000	34 000	137	572	1 263	402	1 720	3 885	127,0	213,0	289,0	•	0,34	XCB7012-E-T-P4S
19 000	30 000	67	201	402	200	630	1 323	45,4	71,4	98,2	•	0,46	HS7012-C-T-P4S
15 000	24 000	107	322	644	307	941	1 921	112,7	168,1	219,3	•	0,46	HS7012-E-T-P4S
20 000	34 000	46	139	279	136	429	895	44,2	68,5	92,4	•	0,43	HC7012-C-T-P4S
19 000	30 000	75	225	451	217	660	1 343	113,2	167,1	216,1	•	0,43	HC7012-E-T-P4S
28 000	43 000	46	139	279	136	429	895	44,2	68,5	92,4	•	0,43	XC7012-C-T-P4S
24 000	38 000	75	225	451	217	660	1 343	113,2	167,1	216,1	•	0,43	XC7012-E-T-P4S
13 000	20 000	315	1 022	2 100	986	3 479	7 697	71,4	122,8	178,8	•	0,80	B7212-C-T-P4S
12 000	19 000	467	1 599	3 333	1 374	4 877	10 509	165,9	265,8	360,8	•	0,80	B7212-E-T-P4S
16 000	26 000	162	557	1 164	496	1 811	4 002	61,3	102,7	145,2	•	0,70	HCB7212-C-T-P4S
14 000	22 000	229	867	1 866	674	2 612	5 767	145,8	236,5	318,7	•	0,70	HCB7212-E-T-P4S

X-life ultra design

XCB7012-E-2RSD-T-P4S-UL
XC7012-EDLR-T-P4S-UL

TX design

HCB7012-C-TX-P4S-UL
XC7012-EDLR-TX-P4S-UL

FAG Spindle Bearings

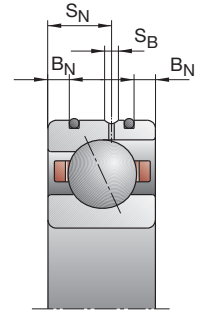
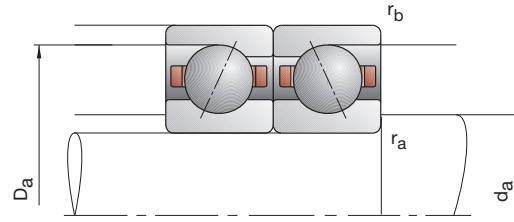
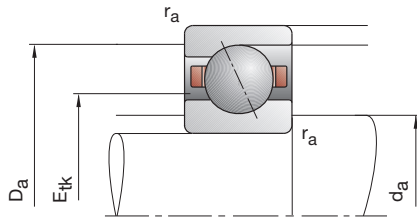

Bearing code	Dimensions					Abutment dimensions				DLR dimensions			Load rating			
	d	D	B	r _{smin}	r _{1smin}	d _a	D _a	r _a	r _b	B _N	S _N	S _B	E _{tk} nom.	C _{dyn}	C _{0stat}	
FAG	mm														kN	
B71813-C-TPA-P4	65	85	10	0,60	0,30	69	80,5	0,6	0,3				72,3	13,40	14,00	
B71813-E-TPA-P4	65	85	10	0,60	0,30	69	80,5	0,6	0,3				72,3	12,70	12,90	
HCB71813-C-TPA-P4	65	85	10	0,60	0,30	69	80,5	0,6	0,3				72,3	9,30	9,80	
HCB71813-E-TPA-P4	65	85	10	0,60	0,30	69	80,5	0,6	0,3				72,3	8,80	9,15	
B71913-C-T-P4S	65	90	13	1,00	1,00	70	85,5	0,6	0,6				75,1	24,50	24,00	
B71913-E-T-P4S	65	90	13	1,00	1,00	70	85,5	0,6	0,6				75,1	22,80	22,40	
HCB71913-C-T-P4S	65	90	13	1,00	1,00	70	85,5	0,6	0,6	2,8	7,2	1,4	75,1	17,00	16,60	
HCB71913-E-T-P4S	65	90	13	1,00	1,00	70	85,5	0,6	0,6	2,8	7,2	1,4	75,1	16,00	16,00	
XCB71913-C-T-P4S	65	90	13	1,00	1,00	70	85,5	0,6	0,6	2,8	7,2	1,4	75,1	38,00	16,60	
XCB71913-E-T-P4S	65	90	13	1,00	1,00	70	85,5	0,6	0,6	2,8	7,2	1,4	75,1	35,50	16,00	
HS71913-C-T-P4S	65	90	13	1,00		70	85,5	0,6	0,6				75,2	14,30	15,30	
HS71913-E-T-P4S	65	90	13	1,00		70	85,5	0,6	0,6				75,2	13,40	14,30	
HC71913-C-T-P4S	65	90	13	1,00		70	85,5	0,6	0,6	2,8	7,2	1,4	75,2	9,80	10,80	
HC71913-E-T-P4S	65	90	13	1,00		70	85,5	0,6	0,6	2,8	7,2	1,4	75,2	9,30	10,00	
XC71913-C-T-P4S	65	90	13	1,00		70	85,5	0,6	0,6	2,8	7,2	1,4	75,2	22,00	10,80	
XC71913-E-T-P4S	65	90	13	1,00		70	85,5	0,6	0,6	2,8	7,2	1,4	75,2	20,80	10,00	
B7013-C-T-P4S	65	100	18	1,10	1,10	72	93	1,0	0,6				78,1	40,00	35,50	
B7013-E-T-P4S	65	100	18	1,10	1,10	72	93	1,0	0,6				78,1	38,00	33,50	
HCB7013-C-T-P4S	65	100	18	1,10	1,10	72	93	1,0	0,6	4,0	10,4	1,4	78,1	27,50	24,50	
HCB7013-E-T-P4S	65	100	18	1,10	1,10	72	93	1,0	0,6	4,0	10,4	1,4	78,1	26,00	23,60	
XCB7013-C-T-P4S	65	100	18	1,10	1,10	72	93	1,0	0,6	4,0	10,4	1,4	78,1	61,00	24,50	
XCB7013-E-T-P4S	65	100	18	1,10	1,10	72	93	1,0	0,6	4,0	10,4	1,4	78,1	58,50	23,60	
HS7013-C-T-P4S	65	100	18	1,10		72	93	1,0	0,6				79,7	20,00	21,60	
HS7013-E-T-P4S	65	100	18	1,10		72	93	1,0	0,6				79,7	19,00	20,00	
HC7013-C-T-P4S	65	100	18	1,10		72	93	1,0	0,6	4,0	10,4	1,4	79,7	13,70	15,00	
HC7013-E-T-P4S	65	100	18	1,10		72	93	1,0	0,6	4,0	10,4	1,4	79,7	12,90	14,00	
XC7013-C-T-P4S	65	100	18	1,10		72	93	1,0	0,6	4,0	10,4	1,4	79,7	30,50	15,00	
XC7013-E-T-P4S	65	100	18	1,10		72	93	1,0	0,6	4,0	10,4	1,4	79,7	28,50	14,00	
B7213-C-T-P4S	65	120	23	1,50	1,50	75,5	109,5	1,5	1,5				88,2	57,00	48,00	
B7213-E-T-P4S	65	120	23	1,50	1,50	75,5	109,5	1,5	1,5				88,2	54,00	45,50	
HCB7213-C-T-P4S	65	120	23	1,50	1,50	75,5	109,5	1,5	1,5				88,2	40,00	23,60	
HCB7213-E-T-P4S	65	120	23	1,50	1,50	75,5	109,5	1,5	1,5				88,2	37,50	22,40	

- * options; • = possible, – = not possible
- ** see section Engineering, Speeds
- *** see section Engineering, Deflection and Rigidity

Designation examples:

Sealed design

B7013-C-2RSD-T-P4S-UL
HSS7013-E-T-P4S-UL

Hybrid ceramic design

HC7013-E-T-P4S-UL
HCB71813-C-TPA-P4-UL

Direct Lube design

HCB7013-EDLR-T-P4S-UL
HC7013-EDLR-T-P4S-UL

B718..C/E, B719, B70, B72 HS719..C/E, HS70

C: Contact angle $\alpha = 15^\circ$

E: Contact angle $\alpha = 25^\circ$

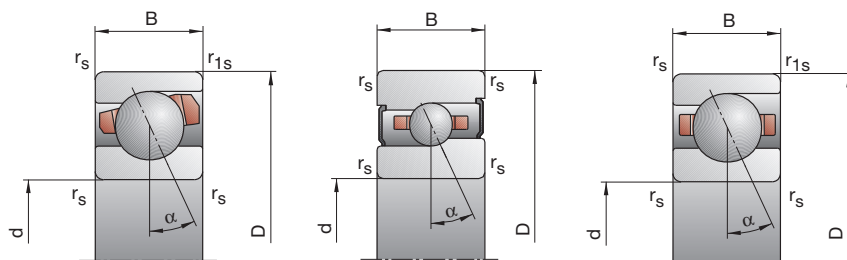

Attainable speed**		Preloading force			Unloading force***			Axial rigidity***			Sealed design*	Weight	Bearing code
Grease	Oil	L	M	H	L	M	H	L	M	H			
min ⁻¹	minimal	N						N/μm			kg	FAG	
15 000	24 000	51	201	440	154	660	1 554	43,6	79,9	118,6	—	0,13	B71813-C-TPA-P4
13 000	20 000	82	289	673	236	857	2 070	106,8	171,0	241,1	—	0,13	B71813-E-TPA-P4
19 000	32 000	24	116	267	71	366	895	36,6	69,1	101,6	—	0,13	HCB71813-C-TPA-P4
16 000	26 000	42	149	384	121	438	1 160	95,5	150,5	215,8	—	0,13	HCB71813-E-TPA-P4
14 000	22 000	118	417	883	364	1 396	3 172	56,5	99,4	145,6	•	0,20	B71913-C-T-P4S
13 000	20 000	153	617	1 348	447	1 860	4 207	127,1	214,0	294,5	•	0,20	B71913-E-T-P4S
18 000	30 000	55	219	479	166	702	1 617	47,1	82,6	117,9	•	0,17	HCB71913-C-T-P4S
15 000	24 000	57	307	721	167	918	2 203	102,3	185,7	256,8	•	0,17	HCB71913-E-T-P4S
24 000	38 000	55	219	479	166	702	1 617	47,1	82,6	117,9	•	0,17	XCB71913-C-T-P4S
20 000	34 000	57	307	721	167	918	2 203	102,3	185,7	256,8	•	0,17	XCB71913-E-T-P4S
19 000	30 000	49	147	295	145	459	965	41,6	65,6	90,0	•	0,23	HS71913-C-T-P4S
15 000	24 000	80	239	478	229	698	1 426	104,6	155,7	203,1	•	0,23	HS71913-E-T-P4S
20 000	34 000	34	103	205	101	317	654	41,1	63,3	84,9	•	0,21	HC71913-C-T-P4S
19 000	30 000	55	166	331	159	486	983	104,4	154,4	199,1	•	0,21	HC71913-E-T-P4S
26 000	43 000	34	103	205	101	317	654	41,1	63,3	84,9	•	0,21	XC71913-C-T-P4S
24 000	38 000	55	166	331	159	486	983	104,4	154,4	199,1	•	0,21	XC71913-E-T-P4S
13 000	20 000	216	720	1 495	672	2 433	5 422	67,1	116,1	169,1	•	0,42	B7013-C-T-P4S
12 000	19 000	310	1 118	2 372	910	3 391	7 452	155,1	252,3	344,4	•	0,42	B7013-E-T-P4S
17 000	28 000	109	391	830	332	1 264	2 837	57,4	97,3	138,1	•	0,36	HCB7013-C-T-P4S
15 000	24 000	137	579	1 281	402	1 739	3 934	131,6	221,3	300,2	•	0,36	HCB7013-E-T-P4S
22 000	36 000	109	391	830	332	1 264	2 837	57,4	97,3	138,1	•	0,36	XCB7013-C-T-P4S
19 000	32 000	137	579	1 281	402	1 739	3 934	131,6	221,3	300,2	•	0,36	XCB7013-E-T-P4S
17 000	28 000	70	209	418	208	654	1 373	48,0	75,5	103,8	•	0,48	HS7013-C-T-P4S
15 000	24 000	112	336	672	321	981	2 002	119,7	178,3	232,5	•	0,48	HS7013-E-T-P4S
20 000	34 000	47	142	284	139	438	907	46,6	72,0	96,7	•	0,45	HC7013-C-T-P4S
18 000	28 000	77	230	460	222	674	1 367	119,2	176,0	227,1	•	0,45	HC7013-E-T-P4S
26 000	40 000	47	142	284	139	438	907	46,6	72,0	96,7	•	0,45	XC7013-C-T-P4S
22 000	36 000	77	230	460	222	674	1 367	119,2	176,0	227,1	•	0,45	XC7013-E-T-P4S
12 000	19 000	325	1 051	2 163	1 015	3 565	7 874	75,1	128,6	186,9	•	1,02	B7213-C-T-P4S
11 000	18 000	482	1 656	3 455	1 417	5 043	10 873	174,9	280,1	380,1	•	1,02	B7213-E-T-P4S
15 000	24 000	170	580	1 213	520	1 882	4 161	64,9	108,3	153,1	•	0,88	HCB7213-C-T-P4S
13 000	20 000	234	892	1 918	688	2 684	5 918	153,2	248,9	334,9	•	0,88	HCB7213-E-T-P4S

X-life ultra design

XCB7013-E-2RSD-T-P4S-UL
XC7013-EDLR-T-P4S-UL

TX design

HCB7013-C-TX-P4S-UL
XC7013-EDLR-TX-P4S-UL

FAG Spindle Bearings

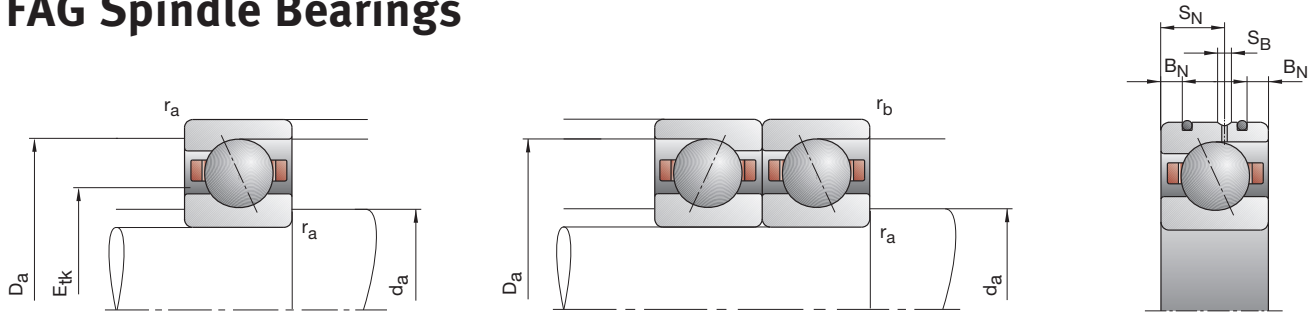

Bearing code	Dimensions					Abutment dimensions				DLR dimensions			Load rating		
	d	D	B	r _{smin}	r _{1smin}	d _a	D _a	r _a	r _b	B _N	S _N	S _B	E _{tk} nom.	C _{dyn}	C _{0stat}
FAG	mm													kN	
B71814-C-TPA-P4	70	90	10	0,60	0,30	74	85,5	0,6	0,3				77,3	14,00	15,00
B71814-E-TPA-P4	70	90	10	0,60	0,30	74	85,5	0,6	0,3				77,3	12,90	13,70
HCB71814-C-TPA-P4	70	90	10	0,60	0,30	74	85,5	0,6	0,3				77,3	9,50	10,40
HCB71814-E-TPA-P4	70	90	10	0,60	0,30	74	85,5	0,6	0,3				77,3	9,50	9,65
B71914-C-T-P4S	70	100	16	1,00	1,00	76	94,5	0,6	0,6				82,2	33,50	32,50
B71914-E-T-P4S	70	100	16	1,00	1,00	76	94,5	0,6	0,6				82,2	31,50	31,00
HCB71914-C-T-P4S	70	100	16	1,00	1,00	76	94,5	0,6	0,6	3,1	9,3	1,4	82,2	23,20	22,80
HCB71914-E-T-P4S	70	100	16	1,00	1,00	76	94,5	0,6	0,6	3,1	9,3	1,4	82,2	22,00	21,60
XCB71914-C-T-P4S	70	100	16	1,00	1,00	76	94,5	0,6	0,6	3,1	9,3	1,4	82,2	52,00	22,80
XCB71914-E-T-P4S	70	100	16	1,00	1,00	76	94,5	0,6	0,6	3,1	9,3	1,4	82,2	49,00	21,60
HS71914-C-T-P4S	70	100	16	1,00		76	94,5	0,6	0,6				82,3	18,30	20,00
HS71914-E-T-P4S	70	100	16	1,00		76	94,5	0,6	0,6				82,3	17,30	18,60
HC71914-C-T-P4S	70	100	16	1,00		76	94,5	0,6	0,6	3,1	9,3	1,4	82,3	12,70	14,00
HC71914-E-T-P4S	70	100	16	1,00		76	94,5	0,6	0,6	3,1	9,3	1,4	82,3	12,00	13,20
XC71914-C-T-P4S	70	100	16	1,00		76	94,5	0,6	0,6	3,1	9,3	1,4	82,3	28,50	14,00
XC71914-E-T-P4S	70	100	16	1,00		76	94,5	0,6	0,6	3,1	9,3	1,4	82,3	27,00	13,20
B7014-C-T-P4S	70	110	20	1,10	1,10	77	102	1,0	0,6				85,0	50,00	43,00
B7014-E-T-P4S	70	110	20	1,10	1,10	77	102	1,0	0,6				85,0	46,50	41,50
HCB7014-C-T-P4S	70	110	20	1,10	1,10	77	102	1,0	0,6	4,0	11,6	1,4	85,0	34,00	30,00
HCB7014-E-T-P4S	70	110	20	1,10	1,10	77	102	1,0	0,6	4,0	11,6	1,4	85,0	32,50	29,00
XCB7014-C-T-P4S	70	110	20	1,10	1,10	77	102	1,0	0,6	4,0	11,6	1,4	85,0	76,50	30,00
XCB7014-E-T-P4S	70	110	20	1,10	1,10	77	102	1,0	0,6	4,0	11,6	1,4	85,0	72,00	29,00
HS7014-C-T-P4S	70	110	20	1,10		77	102	1,0	0,6				86,7	26,00	28,00
HS7014-E-T-P4S	70	110	20	1,10		77	102	1,0	0,6				86,7	24,50	26,00
HC7014-C-T-P4S	70	110	20	1,10		77	102	1,0	0,6	4,0	11,6	1,4	86,7	18,00	19,60
HC7014-E-T-P4S	70	110	20	1,10		77	102	1,0	0,6	4,0	11,6	1,4	86,7	17,00	18,30
XC7014-C-T-P4S	70	110	20	1,10		77	102	1,0	0,6	4,0	11,6	1,4	86,7	40,00	19,60
XC7014-E-T-P4S	70	110	20	1,10		77	102	1,0	0,6	4,0	11,6	1,4	86,7	38,00	18,30
B7214-C-T-P4S	70	125	24	1,50	1,50	80	115	1,5	1,5				92,7	69,50	58,50
B7214-E-T-P4S	70	125	24	1,50	1,50	80	115	1,5	1,5				92,7	65,50	56,00
HCB7214-C-T-P4S	70	125	24	1,50	1,50	80	115	1,5	1,5				92,7	48,00	40,50
HCB7214-E-T-P4S	70	125	24	1,50	1,50	80	115	1,5	1,5				92,7	45,50	39,00

* options; • = possible, – = not possible

** see section Engineering, Speeds

*** see section Engineering, Deflection and Rigidity

Designation examples:

Sealed design

B7014-C-2RSD-T-P4S-UL

HSS7014-E-T-P4S-UL

Hybrid ceramic design

HC7014-E-T-P4S-UL

HCB71814-C-TPA-P4-UL

Direct Lube design

HCB7014-EDLR-T-P4S-UL

HC7014-EDLR-T-P4S-UL

B718..C/E, B719, B70, B72 HS719..C/E, HS70

C: Contact angle $\alpha = 15^\circ$
E: Contact angle $\alpha = 25^\circ$

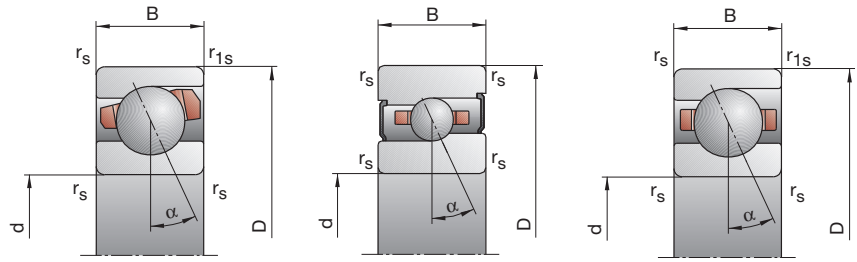

70

Attainable speed**		Preloading force F_V			Unloading force*** K_{aE}			Axial rigidity*** c_a			Sealed design*	Weight	Bearing code
Grease	Oil	L	M	H	L	M	H	L	M	H		kg	FAG
min ⁻¹	minimal	N						N/μm					
14 000	22 000	53	210	459	160	688	1 617	46,1	84,4	125,2	—	0,14	B71814-C-TPA-P4
13 000	20 000	81	289	678	233	855	2 079	111,0	178,1	251,3	—	0,14	B71814-E-TPA-P4
18 000	30 000	24	120	277	71	378	927	38,2	72,9	107,1	—	0,14	HCB71814-C-TPA-P4
15 000	24 000	40	147	387	115	431	1 166	97,9	156,1	225,3	—	0,14	HCB71814-E-TPA-P4
13 000	20 000	172	588	1 230	532	1 970	4 418	66,5	115,5	168,2	•	0,33	B71914-C-T-P4S
12 000	19 000	234	890	1 917	684	2 691	5 984	151,6	250,6	342,8	•	0,33	B71914-E-T-P4S
16 000	26 000	82	311	671	248	997	2 271	55,7	96,0	136,7	•	0,28	HCB71914-C-T-P4S
14 000	22 000	96	452	1 026	281	1 351	3 143	125,8	218,6	299,0	•	0,28	HCB71914-E-T-P4S
22 000	36 000	82	311	671	248	997	2 271	55,7	96,0	136,7	•	0,28	XCB71914-C-T-P4S
18 000	30 000	96	452	1 026	281	1 351	3 143	125,8	218,6	299,0	•	0,28	XCB71914-E-T-P4S
16 000	26 000	64	192	383	190	600	1 254	47,6	75,0	102,6	•	0,37	HS71914-C-T-P4S
14 000	22 000	103	308	616	295	898	1 833	119,0	176,9	230,7	•	0,37	HS71914-E-T-P4S
19 000	32 000	44	131	263	131	403	839	46,9	71,5	96,3	•	0,35	HC71914-C-T-P4S
17 000	26 000	71	214	428	205	626	1 271	118,8	175,4	226,7	•	0,35	HC71914-E-T-P4S
24 000	40 000	44	131	263	131	403	839	46,9	71,5	96,3	•	0,35	XC71914-C-T-P4S
22 000	36 000	71	214	428	205	626	1 271	118,8	175,4	226,7	•	0,35	XC71914-E-T-P4S
12 000	19 000	278	915	1 888	866	3 095	6 864	73,9	127,3	185,1	•	0,59	B7014-C-T-P4S
11 000	18 000	398	1 397	2 945	1 167	4 242	9 262	170,1	274,3	373,5	•	0,59	B7014-E-T-P4S
16 000	26 000	140	492	1 036	427	1 590	3 538	63,0	106,1	150,1	•	0,50	HCB7014-C-T-P4S
13 000	20 000	184	736	1 609	541	2 208	4 948	146,7	241,9	327,1	•	0,50	HCB7014-E-T-P4S
20 000	34 000	140	492	1 036	427	1 590	3 538	63,0	106,1	150,1	•	0,50	XCB7014-C-T-P4S
17 000	28 000	184	736	1 609	541	2 208	4 948	146,7	241,9	327,1	•	0,50	XCB7014-E-T-P4S
16 000	26 000	89	268	536	265	837	1 757	52,5	82,6	113,5	•	0,67	HS7014-C-T-P4S
13 000	20 000	146	437	874	419	1 277	2 608	131,9	196,4	256,2	•	0,67	HS7014-E-T-P4S
18 000	30 000	63	188	375	187	579	1 202	52,0	79,8	107,4	•	0,63	HC7014-C-T-P4S
16 000	24 000	101	304	607	292	892	1 807	131,8	194,9	251,5	•	0,63	HC7014-E-T-P4S
24 000	38 000	63	188	375	187	579	1 202	52,0	79,8	107,4	•	0,63	XC7014-C-T-P4S
20 000	34 000	101	304	607	292	892	1 807	131,8	194,9	251,5	•	0,63	XC7014-E-T-P4S
11 000	18 000	404	1 301	2 664	1 264	4 419	9 712	83,8	143,2	207,6	•	1,12	B7214-C-T-P4S
10 000	17 000	600	2 030	4 233	1 765	6 187	13 319	194,9	310,5	421,0	•	1,12	B7214-E-T-P4S
14 000	22 000	208	708	1 477	635	2 298	5 066	71,8	119,8	169,0	•	0,96	HCB7214-C-T-P4S
12 000	19 000	295	1 101	2 350	868	3 315	7 237	171,5	276,5	370,8	•	0,96	HCB7214-E-T-P4S

X-life ultra design

XCB7014-E-2RSD-T-P4S-UL
XC7014-EDLR-T-P4S-UL

TX design

HCB7014-C-TX-P4S-UL
XC7014-EDLR-TX-P4S-UL

FAG Spindle Bearings

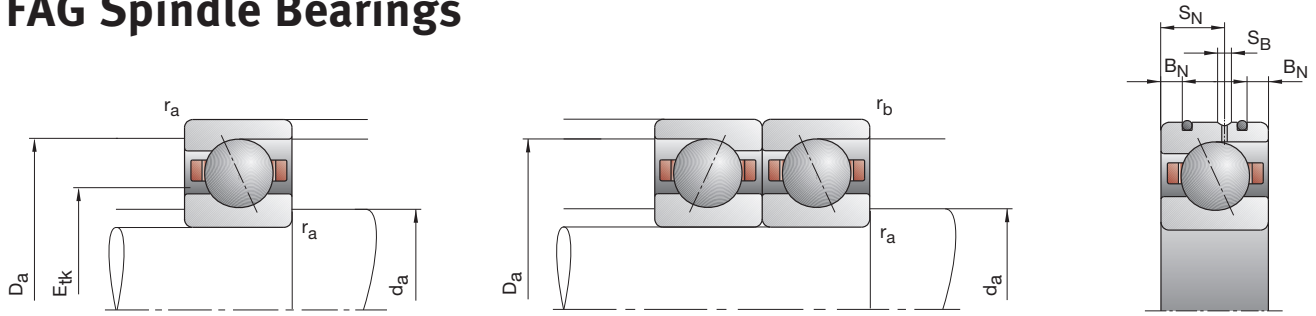

Bearing code	Dimensions					Abutment dimensions				DLR dimensions			Load rating			
	d	D	B	r _{smin}	r _{1smin}	d _a	D _a	r _a	r _b	B _N	S _N	S _B	E _{tk} nom.	C _{dyn}	C _{0stat}	
FAG	mm														kN	
B71815-C-TPA-P4	75	95	10	0,60	0,30	79	90,5	0,6	0,3				82,3	14,30	15,60	
B71815-E-TPA-P4	75	95	10	0,60	0,30	79	90,5	0,6	0,3				82,3	13,40	14,60	
HCB71815-C-TPA-P4	75	95	10	0,60	0,30	79	90,5	0,6	0,3				82,3	9,80	11,00	
HCB71815-E-TPA-P4	75	95	10	0,60	0,30	79	90,5	0,6	0,3				82,3	9,30	10,20	
B71915-C-T-P4S	75	105	16	1,00	1,00	81	99,5	0,6	0,6				87,2	34,00	34,50	
B71915-E-T-P4S	75	105	16	1,00	1,00	81	99,5	0,6	0,6				87,2	32,00	32,50	
HCB71915-C-T-P4S	75	105	16	1,00	1,00	81	99,5	0,6	0,6	3,1	9,3	1,4	87,2	23,60	24,00	
HCB71915-E-T-P4S	75	105	16	1,00	1,00	81	99,5	0,6	0,6	3,1	9,3	1,4	87,2	22,00	22,80	
XCB71915-C-T-P4S	75	105	16	1,00	1,00	81	99,5	0,6	0,6	3,1	9,3	1,4	87,2	53,00	24,00	
XCB71915-E-T-P4S	75	105	16	1,00	1,00	81	99,5	0,6	0,6	3,1	9,3	1,4	87,2	49,00	22,80	
HS71915-C-T-P4S	75	105	16	1,00		81	99,5	0,6	0,6				87,3	19,00	21,20	
HS71915-E-T-P4S	75	105	16	1,00		81	99,5	0,6	0,6				87,3	17,60	20,00	
HC71915-C-T-P4S	75	105	16	1,00		81	99,5	0,6	0,6	3,1	9,3	1,4	87,3	12,90	15,00	
HC71915-E-T-P4S	75	105	16	1,00		81	99,5	0,6	0,6	3,1	9,3	1,4	87,3	12,20	13,70	
XC71915-C-T-P4S	75	105	16	1,00		81	99,5	0,6	0,6	3,1	9,3	1,4	87,3	29,00	15,00	
XC71915-E-T-P4S	75	105	16	1,00		81	99,5	0,6	0,6	3,1	9,3	1,4	87,3	27,00	13,70	
B7015-C-T-P4S	75	115	20	1,10	1,10	82	107	1,0	0,6				90,0	51,00	46,50	
B7015-E-T-P4S	75	115	20	1,10	1,10	82	107	1,0	0,6				90,0	48,00	44,00	
HCB7015-C-T-P4S	75	115	20	1,10	1,10	82	107	1,0	0,6	4,0	11,6	1,4	90,0	35,50	32,50	
HCB7015-E-T-P4S	75	115	20	1,10	1,10	82	107	1,0	0,6	4,0	11,6	1,4	90,0	33,50	30,50	
XCB7015-C-T-P4S	75	115	20	1,10	1,10	82	107	1,0	0,6	4,0	11,6	1,4	90,0	80,00	32,50	
XCB7015-E-T-P4S	75	115	20	1,10	1,10	82	107	1,0	0,6	4,0	11,6	1,4	90,0	75,00	30,50	
HS7015-C-T-P4S	75	115	20	1,10		82	107	1,0	0,6				91,7	26,50	29,00	
HS7015-E-T-P4S	75	115	20	1,10		82	107	1,0	0,6				91,7	25,00	27,00	
HC7015-C-T-P4S	75	115	20	1,10		82	107	1,0	0,6	4,0	11,6	1,4	91,7	18,30	20,00	
HC7015-E-T-P4S	75	115	20	1,10		82	107	1,0	0,6	4,0	11,6	1,4	91,7	17,30	18,60	
XC7015-C-T-P4S	75	115	20	1,10		82	107	1,0	0,6	4,0	11,6	1,4	91,7	40,50	20,00	
XC7015-E-T-P4S	75	115	20	1,10		82	107	1,0	0,6	4,0	11,6	1,4	91,7	38,00	18,60	
B7215-C-T-P4S	75	130	25	1,50	1,50	85	120	1,5	1,5				97,7	72,00	63,00	
B7215-E-T-P4S	75	130	25	1,50	1,50	85	120	1,5	1,5				97,7	68,00	60,00	
HCB7215-C-T-P4S	75	130	25	1,50	1,50	85	120	1,5	1,5				97,7	50,00	44,00	
HCB7215-E-T-P4S	75	130	25	1,50	1,50	85	120	1,5	1,5				97,7	47,50	41,50	

* options; • = possible, – = not possible

** see section Engineering, Speeds

*** see section Engineering, Deflection and Rigidity

Designation examples:

Sealed design

B7015-C-2RSD-T-P4S-UL

HSS7015-E-T-P4S-UL

Hybrid ceramic design

HC7015-E-T-P4S-UL

HCB71815-C-TPA-P4-UL

Direct Lube design

HCB7015-EDLR-T-P4S-UL

HC7015-EDLR-T-P4S-UL

B718..C/E, B719, B70, B72 HS719..C/E, HS70

C: Contact angle $\alpha = 15^\circ$
E: Contact angle $\alpha = 25^\circ$

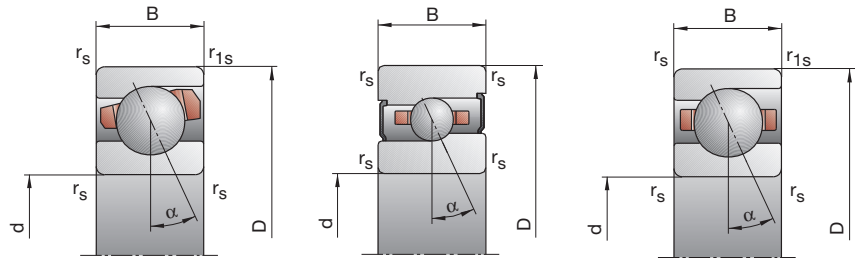

Attainable speed**		Preloading force F_V			Unloading force*** K_{aE}			Axial rigidity*** c_a			Sealed design*	Weight	Bearing code
Grease	Oil	L	M	H	L	M	H	L	M	H		kg	FAG
min ⁻¹	minimal	N						N/μm					
13 000	20 000	53	213	467	159	695	1 638	47,7	87,8	130,1	—	0,14	B71815-C-TPA-P4
12 000	19 000	84	298	702	241	881	2 150	116,8	187,3	264,5	—	0,14	B71815-E-TPA-P4
16 000	26 000	24	120	280	71	377	933	39,8	75,6	111,2	—	0,14	HCB71815-C-TPA-P4
14 000	22 000	41	148	392	118	434	1 180	103,0	163,0	235,4	—	0,14	HCB71815-E-TPA-P4
12 000	19 000	174	596	1 246	537	1 991	4 460	68,5	118,8	172,7	•	0,35	B71915-C-T-P4S
11 000	18 000	236	901	1 943	689	2 721	6 055	156,2	258,3	353,3	•	0,35	B71915-E-T-P4S
16 000	26 000	84	320	691	254	1 025	2 336	57,7	99,6	141,7	•	0,30	HCB71915-C-T-P4S
13 000	20 000	96	457	1 039	280	1 365	3 179	128,9	225,4	308,4	•	0,30	HCB71915-E-T-P4S
20 000	34 000	84	320	691	254	1 025	2 336	57,7	99,6	141,7	•	0,30	XCB71915-C-T-P4S
17 000	28 000	96	457	1 039	280	1 365	3 179	128,9	225,4	308,4	•	0,30	XCB71915-E-T-P4S
16 000	26 000	65	196	391	193	611	1 276	49,8	78,3	107,0	•	0,40	HS71915-C-T-P4S
13 000	20 000	105	315	630	301	918	1 872	124,8	185,4	241,4	•	0,40	HS71915-E-T-P4S
18 000	30 000	45	134	268	133	412	852	48,8	74,9	100,3	•	0,37	HC71915-C-T-P4S
16 000	24 000	73	219	437	211	641	1 297	125,0	184,1	237,4	•	0,37	HC71915-E-T-P4S
23 000	40 000	45	134	268	133	412	852	48,8	74,9	100,3	•	0,37	XC71915-C-T-P4S
19 000	32 000	73	219	437	211	641	1 297	125,0	184,1	237,4	•	0,37	XC71915-E-T-P4S
12 000	19 000	283	931	1 923	880	3 138	6 964	76,8	131,9	191,7	•	0,62	B7015-C-T-P4S
11 000	18 000	408	1 439	3 027	1 196	4 365	9 505	177,7	286,7	389,8	•	0,62	B7015-E-T-P4S
15 000	24 000	144	509	1 071	439	1 643	3 650	65,9	111,0	156,8	•	0,53	HCB7015-C-T-P4S
13 000	20 000	190	762	1 667	557	2 285	5 122	153,6	253,5	342,7	•	0,53	HCB7015-E-T-P4S
19 000	32 000	144	509	1 071	439	1 643	3 650	65,9	111,0	156,8	•	0,53	XCB7015-C-T-P4S
16 000	26 000	190	762	1 667	557	2 285	5 122	153,6	253,5	342,7	•	0,53	XCB7015-E-T-P4S
15 000	24 000	91	273	547	270	852	1 790	54,0	85,0	116,7	•	0,71	HS7015-C-T-P4S
13 000	20 000	148	444	888	425	1 297	2 647	135,8	201,9	263,2	•	0,71	HS7015-E-T-P4S
17 000	28 000	63	188	375	187	578	1 199	53,2	81,4	109,5	•	0,66	HC7015-C-T-P4S
16 000	24 000	101	304	607	292	891	1 805	134,9	199,2	257,0	•	0,66	HC7015-E-T-P4S
22 000	36 000	63	188	375	187	578	1 199	53,2	81,4	109,5	•	0,66	XC7015-C-T-P4S
19 000	32 000	101	304	607	292	891	1 805	134,9	199,2	257,0	•	0,66	XC7015-E-T-P4S
11 000	18 000	416	1 346	2 757	1 299	4 560	10 021	87,8	150,1	217,4	•	1,21	B7215-C-T-P4S
9 500	16 000	619	2 103	4 389	1 820	6 402	13 790	204,9	326,6	442,6	•	1,21	B7215-E-T-P4S
14 000	22 000	215	733	1 531	656	2 375	5 239	75,5	125,8	177,4	•	1,05	HCB7215-C-T-P4S
12 000	19 000	306	1 142	2 439	900	3 436	7 503	180,6	291,2	390,2	•	1,05	HCB7215-E-T-P4S

X-life ultra design

XCB7015-E-2RSD-T-P4S-UL
XC7015-EDLR-T-P4S-UL

TX design

HCB7015-C-TX-P4S-UL
XC7015-E-TX-P4S-UL

FAG Spindle Bearings

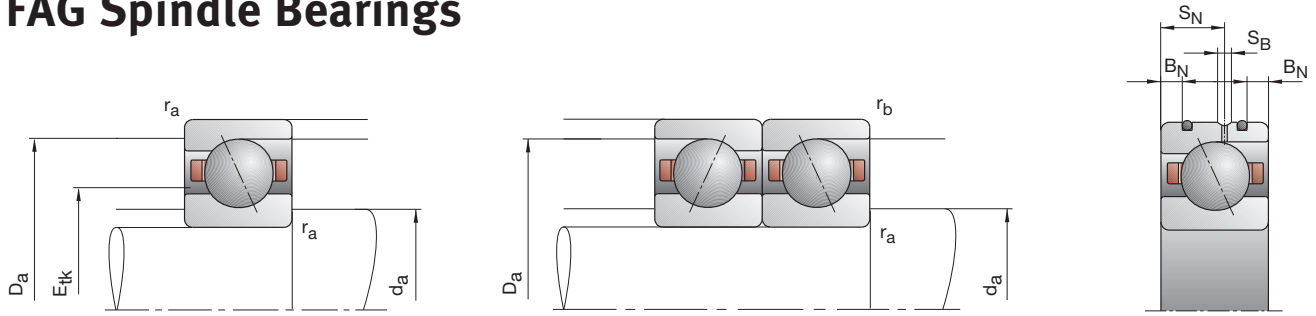

Bearing code	Dimensions					Abutment dimensions				DLR dimensions			Load rating			
	d	D	B	r _{smin}	r _{1smin}	d _a	D _a	r _a	r _b	B _N	S _N	S _B	E _{tk} nom.	C _{dyn}	C _{0stat}	
FAG	mm														kN	
B71816-C-TPA-P4	80	100	10	0,60	0,30	84	95,5	0,6	0,3				87,3	14,60	16,60	
B71816-E-TPA-P4	80	100	10	0,60	0,30	84	95,5	0,6	0,3				87,3	13,70	15,60	
HCB71816-C-TPA-P4	80	100	10	0,60	0,30	84	95,5	0,6	0,3				87,3	10,00	11,60	
HCB71816-E-TPA-P4	80	100	10	0,60	0,30	84	95,5	0,6	0,3				87,3	9,50	10,80	
B71916-C-T-P4S	80	110	16	1,00	1,00	86	104	0,6	0,6				92,2	34,50	36,00	
B71916-E-T-P4S	80	110	16	1,00	1,00	86	104	0,6	0,6				92,2	32,50	34,00	
HCB71916-C-T-P4S	80	110	16	1,00	1,00	86	104	0,6	0,6	3,1	9,3	1,4	92,2	24,00	25,00	
HCB71916-E-T-P4S	80	110	16	1,00	1,00	86	104	0,6	0,6	3,1	9,3	1,4	92,2	22,40	23,60	
XCB71916-C-T-P4S	80	110	16	1,00	1,00	86	104	0,6	0,6	3,1	9,3	1,4	92,2	54,00	25,00	
XCB71916-E-T-P4S	80	110	16	1,00	1,00	86	104	0,6	0,6	3,1	9,3	1,4	92,2	50,00	23,60	
HS71916-C-T-P4S	80	110	16	1,00		86	104	0,6	0,6				92,2	21,20	24,00	
HS71916-E-T-P4S	80	110	16	1,00		86	104	0,6	0,6				92,2	19,60	22,40	
HC71916-C-T-P4S	80	110	16	1,00		86	104	0,6	0,6	3,1	9,3	1,4	92,2	14,60	16,60	
HC71916-E-T-P4S	80	110	16	1,00		86	104	0,6	0,6	3,1	9,3	1,4	92,2	13,70	15,60	
XC71916-C-T-P4S	80	110	16	1,00		86	104	0,6	0,6	3,1	9,3	1,4	92,2	32,50	16,60	
XC71916-E-T-P4S	80	110	16	1,00		86	104	0,6	0,6	3,1	9,3	1,4	92,2	30,50	15,60	
B7016-C-T-P4S	80	125	22	1,10	1,10	88	117	1,0	0,6				96,8	63,00	58,50	
B7016-E-T-P4S	80	125	22	1,10	1,10	88	117	1,0	0,6				96,8	60,00	55,00	
HCB7016-C-T-P4S	80	125	22	1,10	1,10	88	117	1,0	0,6	4,7	12,2	2,2	96,8	44,00	40,50	
HCB7016-E-T-P4S	80	125	22	1,10	1,10	88	117	1,0	0,6	4,7	12,2	2,2	96,8	41,50	39,00	
XCB7016-C-T-P4S	80	125	22	1,10	1,10	88	117	1,0	0,6	4,7	12,2	2,2	96,8	98,00	40,50	
XCB7016-E-T-P4S	80	125	22	1,10	1,10	88	117	1,0	0,6	4,7	12,2	2,2	96,8	93,00	39,00	
HS7016-C-T-P4S	80	125	22	1,10		88	117	1,0	0,6				98,9	31,50	34,50	
HS7016-E-T-P4S	80	125	22	1,10		88	117	1,0	0,6				98,9	30,00	32,50	
HC7016-C-T-P4S	80	125	22	1,10		88	117	1,0	0,6	4,7	12,2	2,2	98,9	21,60	24,50	
HC7016-E-T-P4S	80	125	22	1,10		88	117	1,0	0,6	4,7	12,2	2,2	98,9	20,40	22,80	
XC7016-C-T-P4S	80	125	22	1,10		88	117	1,0	0,6	4,7	12,2	2,2	98,9	48,00	24,50	
XC7016-E-T-P4S	80	125	22	1,10		88	117	1,0	0,6	4,7	12,2	2,2	98,9	45,50	22,80	
B7216-C-T-P4S	80	140	26	2,00	2,00	94	126	2,0	2,0				105,2	73,50	68,00	
B7216-E-T-P4S	80	140	26	2,00	2,00	94	126	2,0	2,0				105,2	71,00	64,00	
HCB7216-C-T-P4S	80	140	26	2,00	2,00	94	126	2,0	2,0				105,2	51,00	47,50	
HCB7216-E-T-P4S	80	140	26	2,00	2,00	94	126	2,0	2,0				105,2	49,00	45,00	

* options; • = possible, – = not possible

** see section Engineering, Speeds

*** see section Engineering, Deflection and Rigidity

Designation examples:

Sealed design

B7016-C-2RSD-T-P4S-UL

HSS7016-E-T-P4S-UL

Hybrid ceramic design

HC7016-E-T-P4S-UL

HCB71816-C-TPA-P4-UL

Direct Lube design

HCB7016-EDLR-T-P4S-UL

HC7016-EDLR-T-P4S-UL

B718..C/E, B719, B70, B72 HS719..C/E, HS70

C: Contact angle $\alpha = 15^\circ$
E: Contact angle $\alpha = 25^\circ$

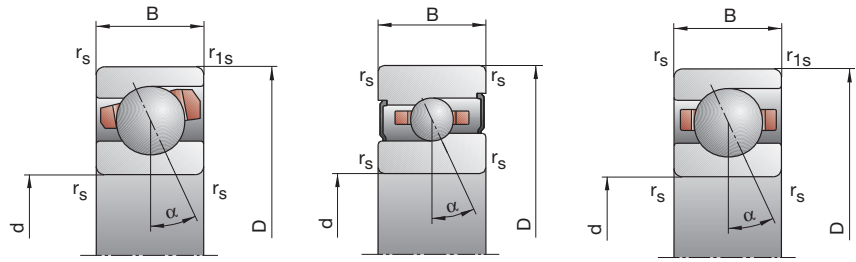

Attainable speed**		Preloading force F_V			Unloading force*** K_{aE}			Axial rigidity*** c_a			Sealed design*	Weight kg	Bearing code FAG
Grease	Oil	L	M	H	L	M	H	L	M	H			
min ⁻¹	minimal	N						N/μm					
12000	19000	53	216	474	159	703	1655	49,5	91,2	134,9	—	0,15	B71816-C-TPA-P4
11000	18000	84	302	712	241	892	2176	121,4	195,3	275,3	—	0,15	B71816-E-TPA-P4
16000	26000	23	121	282	68	379	935	40,7	78,4	115,0	—	0,15	HCB71816-C-TPA-P4
13000	20000	41	152	402	118	445	1208	107,1	170,7	246,3	—	0,15	HCB71816-E-TPA-P4
12000	19000	175	603	1262	539	2009	4504	70,3	122,0	177,2	•	0,37	B71916-C-T-P4S
11000	18000	238	911	1969	695	2748	6127	160,9	266,0	363,7	•	0,37	B71916-E-T-P4S
15000	24000	83	319	689	251	1019	2320	59,0	101,8	144,5	•	0,31	HCB71916-C-T-P4S
13000	20000	96	462	1052	280	1379	3215	132,5	232,3	317,6	•	0,31	HCB71916-E-T-P4S
19000	32000	83	319	689	251	1019	2320	59,0	101,8	144,5	•	0,31	XCB71916-C-T-P4S
16000	26000	96	462	1052	280	1379	3215	132,5	232,3	317,6	•	0,31	XCB71916-E-T-P4S
15000	24000	73	218	437	217	679	1425	52,9	82,6	113,1	•	0,41	HS71916-C-T-P4S
13000	20000	117	352	704	335	1026	2092	131,8	196,3	255,6	•	0,41	HS71916-E-T-P4S
17000	28000	50	150	300	148	461	954	51,7	79,3	106,3	•	0,38	HC71916-C-T-P4S
16000	24000	81	244	488	234	714	1448	132,0	194,7	251,1	•	0,38	HC71916-E-T-P4S
22000	36000	50	150	300	148	461	954	51,7	79,3	106,3	•	0,38	XC71916-C-T-P4S
19000	32000	81	244	488	234	714	1448	132,0	194,7	251,1	•	0,38	XC71916-E-T-P4S
11000	18000	357	1163	2391	1110	3920	8635	86,3	147,5	213,5	•	0,84	B7016-C-T-P4S
9500	16000	529	1830	3825	1552	5557	11989	201,7	323,3	437,9	•	0,84	B7016-E-T-P4S
14000	22000	185	643	1345	564	2077	4585	74,5	124,8	175,8	•	0,71	HCB7016-C-T-P4S
12000	19000	250	967	2089	734	2902	6423	175,2	285,5	384,2	•	0,71	HCB7016-E-T-P4S
18000	30000	185	643	1345	564	2077	4585	74,5	124,8	175,8	•	0,71	XCB7016-C-T-P4S
15000	24000	250	967	2089	734	2902	6423	175,2	285,5	384,2	•	0,71	XCB7016-E-T-P4S
14000	22000	109	328	657	323	1024	2150	59,1	93,2	127,9	•	0,96	HS7016-C-T-P4S
12000	19000	175	524	1049	502	1530	3127	147,9	220,0	287,0	•	0,96	HS7016-E-T-P4S
16000	26000	74	222	445	219	682	1418	57,7	88,7	119,3	•	0,89	HC7016-C-T-P4S
14000	20000	123	368	736	355	1079	2185	148,4	219,2	282,8	•	0,89	HC7016-E-T-P4S
20000	34000	74	222	445	219	682	1418	57,7	88,7	119,3	•	0,89	XC7016-C-T-P4S
17000	28000	123	368	736	355	1079	2185	148,4	219,2	282,8	•	0,89	XC7016-E-T-P4S
10000	17000	424	1354	2701	1309	4516	10274	91,7	155,0	220,5	•	1,52	B7216-C-T-P4S
9000	15000	662	2249	4899	1928	6770	14523	221,2	351,9	475,3	•	1,52	B7216-E-T-P4S
12000	19000	224	761	1570	669	2400	5217	79,4	131,4	183,7	•	1,40	HCB7216-C-T-P4S
11000	18000	325	1219	2611	935	3583	7847	193,9	312,5	418,7	•	1,40	HCB7216-E-T-P4S

X-life ultra design

XCB7016-E-2RSD-T-P4S-UL
XC7016-EDLR-T-P4S-UL

TX design

HCB7016-C-TX-P4S-UL
XC7016-EDLR-TX-P4S-UL

FAG Spindle Bearings

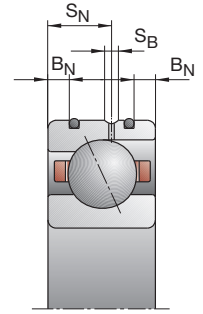
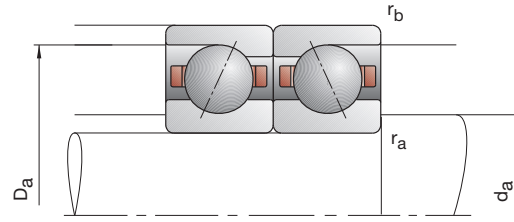
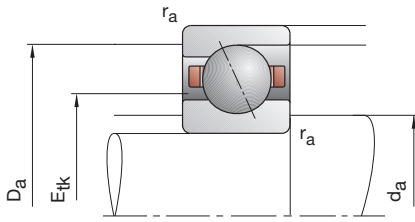

Bearing code	Dimensions					Abutment dimensions				DLR dimensions			Load rating		
	d	D	B	r _{smin}	r _{1smin}	d _a	D _a	r _a	r _b	B _N	S _N	S _B	E _{tk} nom.	C _{dyn}	C _{0stat}
FAG	mm														
B71817-C-TPA-P4	85	110	13	1,00	0,30	90	104,5	1,0	0,3				94,1	21,60	24,00
B71817-E-TPA-P4	85	110	13	1,00	0,30	90	104,5	1,0	0,3				94,1	20,40	22,40
HCB71817-C-TPA-P4	85	110	13	1,00	0,30	90	104,5	1,0	0,3				94,1	15,00	16,60
HCB71817-E-TPA-P4	85	110	13	1,00	0,30	90	104,5	1,0	0,3				94,1	14,00	15,60
B71917-C-T-P4S	85	120	18	1,10	1,10	92	114	0,6	0,6				99,2	45,00	46,50
B71917-E-T-P4S	85	120	18	1,10	1,10	92	114	0,6	0,6				99,2	42,50	44,00
HCB71917-C-T-P4S	85	120	18	1,10	1,10	92	114	0,6	0,6	4,0	10,4	2,2	99,2	31,00	32,50
HCB71917-E-T-P4S	85	120	18	1,10	1,10	92	114	0,6	0,6	4,0	10,4	2,2	99,2	29,00	30,50
XCB71917-C-T-P4S	85	120	18	1,10	1,10	92	114	0,6	0,6	4,0	10,4	2,2	99,2	69,50	32,50
XCB71917-E-T-P4S	85	120	18	1,10	1,10	92	114	0,6	0,6	4,0	10,4	2,2	99,2	64,00	30,50
HS71917-C-T-P4S	85	120	18	1,10		92	114	0,6	0,6				99,7	22,00	26,00
HS71917-E-T-P4S	85	120	18	1,10		92	114	0,6	0,6				99,7	20,40	24,50
HC71917-C-T-P4S	85	120	18	1,10		92	114	0,6	0,6	4,0	10,4	2,2	99,7	15,00	18,00
HC71917-E-T-P4S	85	120	18	1,10		92	114	0,6	0,6	4,0	10,4	2,2	99,7	14,30	17,00
XC71917-C-T-P4S	85	120	18	1,10		92	114	0,6	0,6	4,0	10,4	2,2	99,7	33,50	18,00
XC71917-E-T-P4S	85	120	18	1,10		92	114	0,6	0,6	4,0	10,4	2,2	99,7	32,00	17,00
B7017-C-T-P4S	85	130	22	1,10	1,10	93	122	1,0	0,6				101,8	65,50	62,00
B7017-E-T-P4S	85	130	22	1,10	1,10	93	122	1,0	0,6				101,8	62,00	58,50
HCB7017-C-T-P4S	85	130	22	1,10	1,10	93	122	1,0	0,6	4,7	12,2	2,2	101,8	45,00	43,00
HCB7017-E-T-P4S	85	130	22	1,10	1,10	93	122	1,0	0,6	4,7	12,2	2,2	101,8	42,50	40,50
XCB7017-C-T-P4S	85	130	22	1,10	1,10	93	122	1,0	0,6	4,7	12,2	2,2	101,8	100,00	43,00
XCB7017-E-T-P4S	85	130	22	1,10	1,10	93	122	1,0	0,6	4,7	12,2	2,2	101,8	95,00	40,50
HS7017-C-T-P4S	85	130	22	1,10		93	122	1,0	0,6				103,9	32,00	36,00
HS7017-E-T-P4S	85	130	22	1,10		93	122	1,0	0,6				103,9	30,00	33,50
HC7017-C-T-P4S	85	130	22	1,10		93	122	1,0	0,6	4,7	12,2	2,2	103,9	22,00	25,00
HC7017-E-T-P4S	85	130	22	1,10		93	122	1,0	0,6	4,7	12,2	2,2	103,9	20,80	23,20
XC7017-C-T-P4S	85	130	22	1,10		93	122	1,0	0,6	4,7	12,2	2,2	103,9	49,00	25,00
XC7017-E-T-P4S	85	130	22	1,10		93	122	1,0	0,6	4,7	12,2	2,2	103,9	46,50	23,20
B7217-C-T-P4S	85	150	28	2,00	2,00	98	138	2,0	2,0				112,3	96,50	85,00
B7217-E-T-P4S	85	150	28	2,00	2,00	98	138	2,0	2,0				112,3	91,50	80,00
HCB7217-C-T-P4S	85	150	28	2,00	2,00	98	138	2,0	2,0				112,3	67,00	58,50
HCB7217-E-T-P4S	85	150	28	2,00	2,00	98	138	2,0	2,0				112,3	63,00	56,00

- * options; • = possible, – = not possible
- ** see section Engineering, Speeds
- *** see section Engineering, Deflection and Rigidity

Designation examples:

Sealed design

B7017-C-2RSD-T-P4S-UL
HSS7017-E-T-P4S-UL

Hybrid ceramic design

HC7017-E-T-P4S-UL
HCB71817-C-TPA-P4-UL

Direct Lube design

HCB7017-EDLR-T-P4S-UL
HC7017-EDLR-T-P4S-UL

B718..C/E, B719, B70, B72 HS719..C/E, HS70

C: Contact angle $\alpha = 15^\circ$

E: Contact angle $\alpha = 25^\circ$

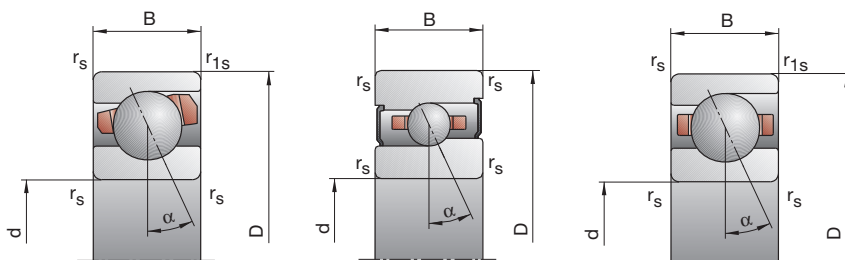

Attainable speed**		Preloading force F_V			Unloading force*** K_{aE}			Axial rigidity*** c_a			Sealed design*	Weight kg	Bearing code FAG
Grease	Oil	L	M	H	L	M	H	L	M	H			
min ⁻¹	minimal	N						N/μm					
11 000	18 000	93	344	739	281	1 129	2 603	59,5	106,2	156,2	—	0,27	B71817-C-TPA-P4
10 000	17 000	113	507	1 142	325	1 508	3 507	131,7	230,0	319,4	—	0,27	B71817-E-TPA-P4
14 000	22 000	48	205	457	143	650	1 532	51,8	93,4	135,2	—	0,27	HCB71817-C-TPA-P4
12 000	19 000	89	279	678	258	823	2 048	137,5	207,1	290,5	—	0,27	HCB71817-E-TPA-P4
11 000	18 000	239	804	1 672	739	2 687	5 982	80,3	138,0	200,0	•	0,53	B71917-C-T-P4S
9 500	16 000	336	1 232	2 631	983	3 716	8 205	185,3	301,8	411,4	•	0,53	B71917-E-T-P4S
13 000	20 000	120	438	934	363	1 405	3 160	68,6	116,5	164,9	•	0,45	HCB71917-C-T-P4S
12 000	19 000	148	642	1 436	433	1 921	4 389	157,3	266,2	361,7	•	0,45	HCB71917-E-T-P4S
18 000	30 000	120	438	934	363	1 405	3 160	68,6	116,5	164,9	•	0,45	XCB71917-C-T-P4S
15 000	24 000	148	642	1 436	433	1 921	4 389	157,3	266,2	361,7	•	0,45	XCB71917-E-T-P4S
14 000	22 000	76	228	456	225	708	1 482	56,4	88,3	120,7	•	0,61	HS71917-C-T-P4S
12 000	19 000	123	368	736	352	1 071	2 184	141,7	210,4	273,8	•	0,61	HS71917-E-T-P4S
16 000	26 000	53	158	316	157	485	1 003	55,8	85,2	114,0	•	0,57	HC71917-C-T-P4S
14 000	20 000	84	253	506	242	739	1 499	140,9	208,0	268,3	•	0,57	HC71917-E-T-P4S
20 000	34 000	53	158	316	157	485	1 003	55,8	85,2	114,0	•	0,57	XC71917-C-T-P4S
17 000	28 000	84	253	506	242	739	1 499	140,9	208,0	268,3	•	0,57	XC71917-E-T-P4S
10 000	17 000	370	1 209	2 484	1 150	4 070	8 957	90,3	154,3	223,1	•	0,89	B7017-C-T-P4S
9 000	15 000	545	1 888	3 949	1 598	5 728	12 364	210,6	337,5	457,1	•	0,89	B7017-E-T-P4S
13 000	20 000	192	667	1 401	585	2 152	4 772	78,0	130,5	184,1	•	0,74	HCB7017-C-T-P4S
11 000	18 000	260	1 008	2 179	763	3 024	6 697	183,6	299,5	402,9	•	0,74	HCB7017-E-T-P4S
17 000	28 000	192	667	1 401	585	2 152	4 772	78,0	130,5	184,1	•	0,74	XCB7017-C-T-P4S
14 000	22 000	260	1 008	2 179	763	3 024	6 697	183,6	299,5	402,9	•	0,74	XCB7017-E-T-P4S
13 000	20 000	109	328	657	323	1 022	2 144	60,5	95,1	130,2	•	0,99	HS7017-C-T-P4S
11 000	18 000	178	534	1 067	509	1 559	3 178	151,9	226,4	294,9	•	0,99	HS7017-E-T-P4S
15 000	24 000	76	228	456	225	700	1 452	59,6	91,5	122,9	•	0,92	HC7017-C-T-P4S
14 000	20 000	123	368	736	355	1 079	2 183	151,8	224,1	288,9	•	0,93	HC7017-E-T-P4S
19 000	32 000	76	228	456	225	700	1 452	59,6	91,5	122,9	•	0,92	XC7017-C-T-P4S
16 000	26 000	123	368	736	355	1 079	2 183	151,8	224,1	288,9	•	0,93	XC7017-E-T-P4S
9 000	15 000	573	1 825	3 734	1 789	6 176	13 586	99,8	169,5	245,6	—	1,85	B7217-C-T-P4S
8 000	13 000	869	2 889	5 972	2 554	8 786	18 785	234,3	370,6	500,9	—	1,85	B7217-E-T-P4S
11 000	18 000	301	999	2 066	920	3 234	7 057	86,4	142,4	199,8	—	1,58	HCB7217-C-T-P4S
10 000	17 000	437	1 567	3 319	1 287	4 722	10 222	207,8	330,5	441,6	—	1,58	HCB7217-E-T-P4S

X-life ultra design

XCB7017-E-2RSD-T-P4S-UL

XC7017-EDLR-T-P4S-UL

TX design

HCB7017-C-TX-P4S-UL

XC7017-EDLR-TX-P4S-UL

FAG Spindle Bearings

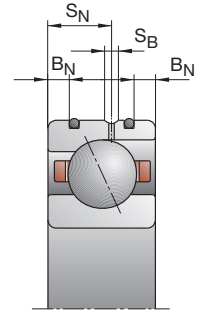
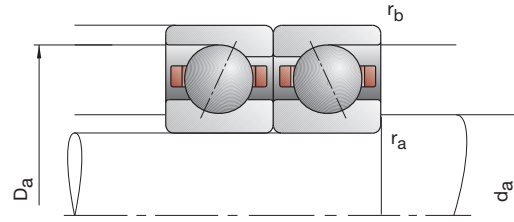
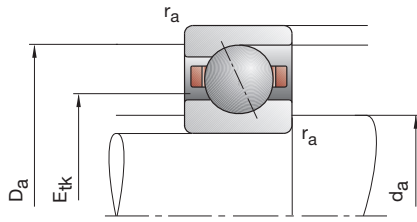

Bearing code	Dimensions					Abutment dimensions				DLR dimensions			Load rating		
	d	D	B	r _{smin}	r _{1smin}	d _a	D _a	r _a	r _b	B _N	S _N	S _B	E _{tk} nom.	C _{dyn}	C _{0stat}
FAG	mm														
B71818-C-TPA-P4	90	115	13	1,00	0,30	95	109,5	1,0	0,3				99,4	21,20	23,60
B71818-E-TPA-P4	90	115	13	1,00	0,30	95	109,5	1,0	0,3				99,4	20,00	22,00
HCB71818-C-TPA-P4	90	115	13	1,00	0,30	95	109,5	1,0	0,3				99,4	14,60	16,60
HCB71818-E-TPA-P4	90	115	13	1,00	0,30	95	109,5	1,0	0,3				99,4	14,00	15,30
B71918-C-T-P4S	90	125	18	1,10	1,10	97	119	0,6	0,6				104,2	45,50	49,00
B71918-E-T-P4S	90	125	18	1,10	1,10	97	119	0,6	0,6				104,2	43,00	46,50
HCB71918-C-T-P4S	90	125	18	1,10	1,10	97	119	0,6	0,6	4,0	10,4	2,2	104,2	31,50	34,00
HCB71918-E-T-P4S	90	125	18	1,10	1,10	97	119	0,6	0,6	4,0	10,4	2,2	104,2	30,00	32,00
XCB71918-C-T-P4S	90	125	18	1,10	1,10	97	119	0,6	0,6	4,0	10,4	2,2	104,2	71,00	34,00
XCB71918-E-T-P4S	90	125	18	1,10	1,10	97	119	0,6	0,6	4,0	10,4	2,2	104,2	67,00	32,00
HS71918-C-T-P4S	90	125	18	1,10		97	119	0,6	0,6				104,5	23,60	28,50
HS71918-E-T-P4S	90	125	18	1,10		97	119	0,6	0,6				104,5	22,40	26,50
HC71918-C-T-P4S	90	125	18	1,10		97	119	0,6	0,6	4,0	10,4	2,2	104,5	16,30	19,60
HC71918-E-T-P4S	90	125	18	1,10		97	119	0,6	0,6	4,0	10,4	2,2	104,5	15,60	18,60
XC71918-C-T-P4S	90	125	18	1,10		97	119	0,6	0,6	4,0	10,4	2,2	104,5	36,50	19,60
XC71918-E-T-P4S	90	125	18	1,10		97	119	0,6	0,6	4,0	10,4	2,2	104,5	34,50	18,60
B7018-C-T-P4S	90	140	24	1,50	1,50	100	131	1,5	0,6				108,6	76,50	72,00
B7018-E-T-P4S	90	140	24	1,50	1,50	100	131	1,5	0,6				108,6	72,00	68,00
HCB7018-C-T-P4S	90	140	24	1,50	1,50	100	131	1,5	0,6	5,5	14,5	2,2	108,6	53,00	50,00
HCB7018-E-T-P4S	90	140	24	1,50	1,50	100	131	1,5	0,6	5,5	14,5	2,2	108,6	50,00	47,50
XCB7018-C-T-P4S	90	140	24	1,50	1,50	100	131	1,5	0,6	5,5	14,5	2,2	108,6	118,00	50,00
XCB7018-E-T-P4S	90	140	24	1,50	1,50	100	131	1,5	0,6	5,5	14,5	2,2	108,6	112,00	47,50
HS7018-C-T-P4S	90	140	24	1,50		100	131	1,5	0,6				111,0	37,50	43,00
HS7018-E-T-P4S	90	140	24	1,50		100	131	1,5	0,6				111,0	35,50	40,00
HC7018-C-T-P4S	90	140	24	1,50		100	131	1,5	0,6	5,5	14,5	2,2	111,0	26,00	30,00
HC7018-E-T-P4S	90	140	24	1,50		100	131	1,5	0,6	5,5	14,5	2,2	111,0	24,50	28,00
XC7018-C-T-P4S	90	140	24	1,50		100	131	1,5	0,6	5,5	14,5	2,2	111,0	58,50	30,00
XC7018-E-T-P4S	90	140	24	1,50		100	131	1,5	0,6	5,5	14,5	2,2	111,0	55,00	28,00
B7218-C-T-P4S	90	160	30	2,00	2,00	104	147	2,0	2,0				118,8	122,00	104,00
B7218-E-T-P4S	90	160	30	2,00	2,00	104	147	2,0	2,0				118,8	116,00	100,00
HCB7218-C-T-P4S	90	160	30	2,00	2,00	104	147	2,0	2,0				118,8	85,00	73,50
HCB7218-E-T-P4S	90	160	30	2,00	2,00	104	147	2,0	2,0				118,8	80,00	69,50

- * options; • = possible, – = not possible
- ** see section Engineering, Speeds
- *** see section Engineering, Deflection and Rigidity

Designation examples:

Sealed design

B7018-C-2RSD-T-P4S-UL
HSS7018-E-T-P4S-UL

Hybrid ceramic design

HC7018-E-T-P4S-UL
HCB71818-C-TPA-P4-UL

Direct Lube design

HCB7018-EDLR-T-P4S-UL
HC7018-EDLR-T-P4S-UL

B718..C/E, B719, B70, B72 HS719..C/E, HS70

C: Contact angle $\alpha = 15^\circ$
E: Contact angle $\alpha = 25^\circ$

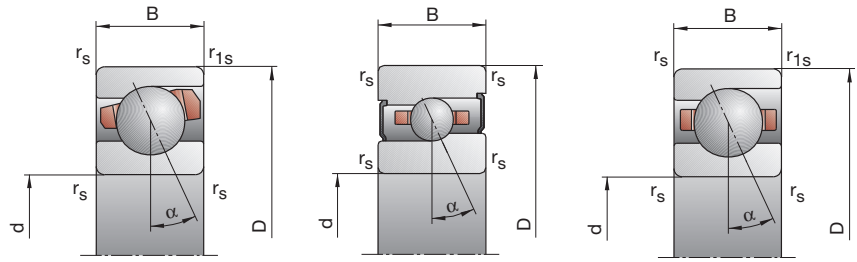

Attainable speed**		Preloading force F_V			Unloading force*** K_{aE}			Axial rigidity*** c_a			Sealed design*	Weight kg	Bearing code FAG
Grease	Oil	L	M	H	L	M	H	L	M	H			
min ⁻¹	minimal	N			N/μm			N/μm					
11 000	18 000	91	337	724	275	1 104	2 544	59,0	105,2	154,5	—	0,28	B71818-C-TPA-P4
9 500	16 000	110	495	1 116	316	1 471	3 423	130,4	227,8	316,3	—	0,28	B71818-E-TPA-P4
14 000	22 000	47	200	446	140	633	1 496	51,4	92,4	133,8	—	0,28	HCB71818-C-TPA-P4
12 000	19 000	79	271	659	228	799	1 989	131,5	205,0	287,4	—	0,28	HCB71818-E-TPA-P4
10 000	17 000	240	811	1 688	740	2 703	6 019	82,3	141,6	204,9	•	0,55	B71918-C-T-P4S
9 000	15 000	337	1 243	2 655	985	3 745	8 266	190,3	310,5	422,9	•	0,55	B71918-E-T-P4S
13 000	20 000	122	445	950	369	1 425	3 207	70,9	120,1	169,8	•	0,47	HCB71918-C-T-P4S
11 000	18 000	149	653	1 461	436	1 953	4 461	162,0	274,9	373,3	•	0,47	HCB71918-E-T-P4S
17 000	28 000	122	445	950	369	1 425	3 207	70,9	120,1	169,8	•	0,47	XCB71918-C-T-P4S
14 000	22 000	149	653	1 461	436	1 953	4 461	162,0	274,9	373,3	•	0,47	XCB71918-E-T-P4S
13 000	20 000	83	249	498	246	772	1 620	58,2	91,0	124,5	•	0,63	HS71918-C-T-P4S
11 000	18 000	133	398	796	381	1 158	2 362	145,7	216,0	281,2	•	0,63	HS71918-E-T-P4S
15 000	24 000	57	170	340	168	520	1 078	56,9	87,1	116,7	•	0,58	HC71918-C-T-P4S
14 000	20 000	92	276	552	265	807	1 636	145,3	214,5	276,5	•	0,58	HC71918-E-T-P4S
19 000	32 000	57	170	340	168	520	1 078	56,9	87,1	116,7	•	0,58	XC71918-C-T-P4S
16 000	26 000	92	276	552	265	807	1 636	145,3	214,5	276,5	•	0,58	XC71918-E-T-P4S
9 500	16 000	440	1 427	2 925	1 369	4 810	10 569	95,8	163,5	236,2	•	1,15	B7018-C-T-P4S
8 500	14 000	649	2 217	4 623	1 905	6 732	14 476	223,6	356,6	482,2	•	1,15	B7018-E-T-P4S
12 000	19 000	227	775	1 622	691	2 501	5 523	82,6	137,2	193,2	•	0,96	HCB7018-C-T-P4S
10 000	17 000	319	1 207	2 585	937	3 625	7 934	196,9	318,6	427,0	•	0,96	HCB7018-E-T-P4S
15 000	24 000	227	775	1 622	691	2 501	5 523	82,6	137,2	193,2	•	0,96	XCB7018-C-T-P4S
13 000	20 000	319	1 207	2 585	937	3 625	7 934	196,9	318,6	427,0	•	0,96	XCB7018-E-T-P4S
12 000	19 000	130	389	777	386	1 212	2 536	66,1	103,5	141,6	•	1,31	HS7018-C-T-P4S
10 000	17 000	207	621	1 242	592	1 813	3 689	164,4	244,9	318,6	•	1,31	HS7018-E-T-P4S
14 000	22 000	89	268	536	264	823	1 706	64,7	99,3	133,3	•	1,22	HC7018-C-T-P4S
13 000	19 000	146	437	874	422	1 278	2 593	165,7	244,0	314,9	•	1,22	HC7018-E-T-P4S
18 000	30 000	89	268	536	264	823	1 706	64,7	99,3	133,3	•	1,22	XC7018-C-T-P4S
15 000	24 000	146	437	874	422	1 278	2 593	165,7	244,0	314,9	•	1,22	XC7018-E-T-P4S
8 500	14 000	738	2 332	4 746	2 308	7 904	17 237	109,7	185,7	267,8	—	2,26	B7218-C-T-P4S
7 500	12 000	1 136	3 717	7 651	3 343	11 322	24 113	258,6	406,9	549,2	—	2,26	B7218-E-T-P4S
11 000	18 000	399	1 309	2 691	1 224	4 252	9 221	96,1	157,7	220,9	—	1,86	HCB7218-C-T-P4S
9 000	15 000	580	2 021	4 246	1 707	6 083	13 095	230,4	362,8	483,7	—	1,86	HCB7218-E-T-P4S

X-life ultra design

XCB7018-E-2RSD-T-P4S-UL
XC7018-EDLR-T-P4S-UL

TX design

HCB7018-C-TX-P4S-UL
XC7018-EDLR-TX-P4S-UL

FAG Spindle Bearings

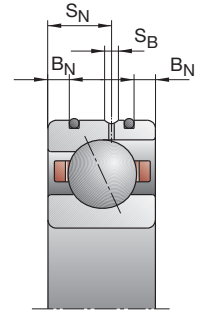
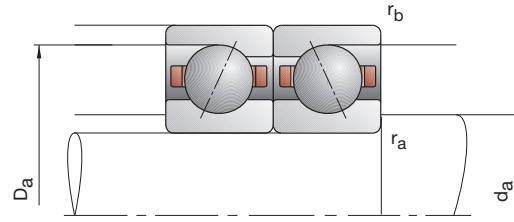
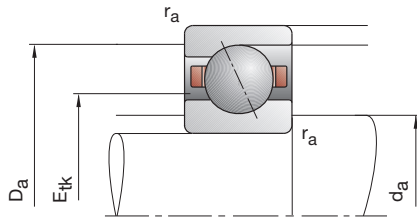

Bearing code	Dimensions					Abutment dimensions				DLR dimensions			Load rating		
	d	D	B	r _{smin}	r _{1smin}	d _a	D _a	r _a	r _b	B _N	S _N	S _B	E _{tk} nom.	C _{dyn}	C _{0stat}
FAG	mm														
B71819-C-TPA-P4	95	120	13	1,00	0,30	100	114,5	1,0	0,3				104,4	21,60	24,50
B71819-E-TPA-P4	95	120	13	1,00	0,30	100	114,5	1,0	0,3				104,4	20,40	22,80
HCB71819-C-TPA-P4	95	120	13	1,00	0,30	100	114,5	1,0	0,3				104,4	15,00	17,00
HCB71819-E-TPA-P4	95	120	13	1,00	0,30	100	114,5	1,0	0,3				104,4	14,00	16,00
B71919-C-T-P4S	95	130	18	1,10	1,10	102	124	0,6	0,6				109,2	46,50	51,00
B71919-E-T-P4S	95	130	18	1,10	1,10	102	124	0,6	0,6				109,2	44,00	48,00
HCB71919-C-T-P4S	95	130	18	1,10	1,10	102	124	0,6	0,6	4,0	10,4	2,2	109,2	32,00	35,50
HCB71919-E-T-P4S	95	130	18	1,10	1,10	102	124	0,6	0,6	4,0	10,4	2,2	109,2	30,50	33,50
XCB71919-C-T-P4S	95	130	18	1,10	1,10	102	124	0,6	0,6	4,0	10,4	2,2	109,2	71,00	35,50
XCB71919-E-T-P4S	95	130	18	1,10	1,10	102	124	0,6	0,6	4,0	10,4	2,2	109,2	68,00	33,50
HS71919-C-T-P4S	95	130	18	1,10		102	124	0,6	0,6				109,5	24,50	30,00
HS71919-E-T-P4S	95	130	18	1,10		102	124	0,6	0,6				109,5	22,80	28,00
HC71919-C-T-P4S	95	130	18	1,10		102	124	0,6	0,6	4,0	10,4	2,2	109,5	17,00	20,80
HC71919-E-T-P4S	95	130	18	1,10		102	124	0,6	0,6	4,0	10,4	2,2	109,5	16,00	19,30
XC71919-C-T-P4S	95	130	18	1,10		102	124	0,6	0,6	4,0	10,4	2,2	109,5	38,00	20,80
XC71919-E-T-P4S	95	130	18	1,10		102	124	0,6	0,6	4,0	10,4	2,2	109,5	35,50	19,30
B7019-C-T-P4S	95	145	24	1,50	1,50	105	136	1,5	0,6				113,6	78,00	76,50
B7019-E-T-P4S	95	145	24	1,50	1,50	105	136	1,5	0,6				113,6	75,00	72,00
HCB7019-C-T-P4S	95	145	24	1,50	1,50	105	136	1,5	0,6	5,5	14,5	2,2	113,6	54,00	53,00
HCB7019-E-T-P4S	95	145	24	1,50	1,50	105	136	1,5	0,6	5,5	14,5	2,2	113,6	51,00	51,00
XCB7019-C-T-P4S	95	145	24	1,50	1,50	105	136	1,5	0,6	5,5	14,5	2,2	113,6	120,00	53,00
XCB7019-E-T-P4S	95	145	24	1,50	1,50	105	136	1,5	0,6	5,5	14,5	2,2	113,6	114,00	51,00
HS7019-C-T-P4S	95	145	24	1,50		105	136	1,5	0,6				116,0	38,00	44,00
HS7019-E-T-P4S	95	145	24	1,50		105	136	1,5	0,6				116,0	35,50	41,50
HC7019-C-T-P4S	95	145	24	1,50		105	136	1,5	0,6	5,5	14,5	2,2	116,0	26,00	31,00
HC7019-E-T-P4S	95	145	24	1,50		105	136	1,5	0,6	5,5	14,5	2,2	116,0	24,50	28,50
XC7019-C-T-P4S	95	145	24	1,50		105	136	1,5	0,6	5,5	14,5	2,2	116,0	58,50	31,00
XC7019-E-T-P4S	95	145	24	1,50		105	136	1,5	0,6	5,5	14,5	2,2	116,0	55,00	28,50
B7219-C-T-P4S	95	170	32	2,10	2,10	110,5	154	2,0	2,0				125,8	127,00	114,00
B7219-E-T-P4S	95	170	32	2,10	2,10	110,5	154	2,0	2,0				125,8	122,00	108,00
HCB7219-C-T-P4S	95	170	32	2,10	2,10	110,5	154	2,0	2,0				125,8	88,00	80,00
HCB7219-E-T-P4S	95	170	32	2,10	2,10	110,5	154	2,0	2,0				125,8	83,00	75,00

- * options; • = possible, – = not possible
- ** see section Engineering, Speeds
- *** see section Engineering, Deflection and Rigidity

Designation examples:

Sealed design

B7019-C-2RSD-T-P4S-UL
HSS7019-E-T-P4S-UL

Hybrid ceramic design

HC7019-E-T-P4S-UL
HCB71918-C-TPA-P4-UL

Direct Lube design

HCB7019-EDLR-T-P4S-UL
HC7019-EDLR-T-P4S-UL

B718..C/E, B719, B70, B72 HS719..C/E, HS70

C: Contact angle $\alpha = 15^\circ$
E: Contact angle $\alpha = 25^\circ$

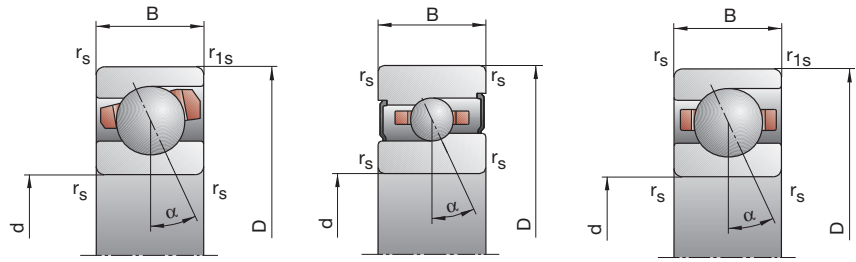

Attainable speed**		Preloading force F_V			Unloading force*** K_{aE}			Axial rigidity*** c_a			Sealed design*	Weight	Bearing code
Grease	Oil	L	M	H	L	M	H	L	M	H		kg	FAG
min ⁻¹	minimal	N			N/μm			N/μm					
10000	17000	92	343	737	278	1122	2586	60,5	107,9	158,4	—	0,29	B71819-C-TPA-P4
9000	15000	111	504	1137	319	1497	3485	133,7	234,0	324,9	—	0,29	B71819-E-TPA-P4
13000	20000	46	199	444	137	629	1484	52,1	94,0	135,7	—	0,29	HCB71819-C-TPA-P4
11000	18000	77	267	655	222	786	1974	133,0	208,0	292,4	—	0,29	HCB71819-E-TPA-P4
9500	16000	245	827	1724	755	2752	6135	84,9	145,9	211,1	•	0,58	B71919-C-T-P4S
8500	14000	343	1269	2713	1002	3820	8439	196,4	320,5	436,5	•	0,58	B71919-E-T-P4S
12000	19000	121	443	947	365	1415	3185	72,3	122,5	173,0	•	0,49	HCB71919-C-T-P4S
10000	17000	150	663	1487	439	1982	4537	166,6	283,4	384,9	•	0,49	HCB71919-E-T-P4S
16000	26000	121	443	947	365	1415	3185	72,3	122,5	173,0	•	0,49	XCB71919-C-T-P4S
14000	22000	150	663	1487	439	1982	4537	166,6	283,4	384,9	•	0,49	XCB71919-E-T-P4S
13000	19000	85	255	509	252	789	1651	60,8	94,8	129,4	•	0,66	HS71919-C-T-P4S
10000	17000	138	414	828	395	1205	2455	152,8	226,9	295,0	•	0,66	HS71919-E-T-P4S
14000	22000	59	177	354	174	541	1122	59,7	91,4	122,5	•	0,61	HC71919-C-T-P4S
13000	19000	96	288	575	277	842	1704	153,1	225,5	290,4	•	0,61	HC71919-E-T-P4S
18000	30000	59	177	354	174	541	1122	59,7	91,4	122,5	•	0,61	XC71919-C-T-P4S
16000	26000	96	288	575	277	842	1704	153,1	225,5	290,4	•	0,61	XC71919-E-T-P4S
9000	15000	447	1452	2980	1388	4880	10731	99,4	169,3	244,3	•	1,20	B7019-C-T-P4S
8000	13000	675	2308	4813	1981	7005	15060	234,4	373,7	505,1	•	1,20	B7019-E-T-P4S
11000	18000	238	811	1692	724	2617	5757	86,7	144,1	202,4	•	1,01	HCB7019-C-T-P4S
9500	16000	325	1231	2641	954	3694	8096	204,9	331,4	444,1	•	1,01	HCB7019-E-T-P4S
15000	24000	238	811	1692	724	2617	5757	86,7	144,1	202,4	•	1,01	XCB7019-C-T-P4S
13000	20000	325	1231	2641	954	3694	8096	204,9	331,4	444,1	•	1,01	XCB7019-E-T-P4S
12000	18000	130	389	777	385	1210	2529	67,4	105,5	144,1	•	1,34	HS7019-C-T-P4S
9500	16000	211	633	1265	604	1847	3756	169,3	251,8	327,5	•	1,34	HS7019-E-T-P4S
13000	20000	89	268	536	263	822	1702	65,9	101,3	135,7	•	1,24	HC7019-C-T-P4S
12000	18000	146	437	874	422	1277	2591	169,3	249,1	321,4	•	1,25	HC7019-E-T-P4S
17000	28000	89	268	536	263	822	1702	65,9	101,3	135,7	•	1,24	XC7019-C-T-P4S
14000	22000	146	437	874	422	1277	2591	169,3	249,1	321,4	•	1,25	XC7019-E-T-P4S
8000	13000	768	2426	4937	2398	8203	17878	115,7	195,6	281,8	—	2,78	B7219-C-T-P4S
7000	11000	1193	3906	8042	3509	11890	25320	274,2	431,5	582,0	—	2,78	B7219-E-T-P4S
10000	17000	411	1353	2784	1258	4384	9513	101,0	165,9	232,1	—	2,36	HCB7219-C-T-P4S
8500	14000	598	2092	4400	1759	6291	13552	242,8	382,6	510,0	—	2,36	HCB7219-E-T-P4S

X-life ultra design

XCB7019-E-2RSD-T-P4S-UL
XC7019-EDLR-T-P4S-UL

TX design

HCB7019-C-TX-P4S-UL
XC7019-EDLR-TX-P4S-UL

FAG Spindle Bearings

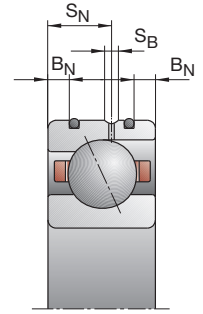
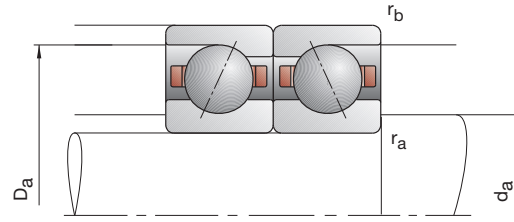
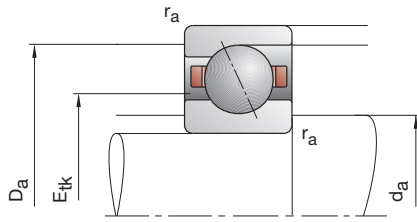

Bearing code	Dimensions					Abutment dimensions				DLR dimensions			Load rating		
	d	D	B	r _{smin}	r _{1smin}	d _a	D _a	r _a	r _b	B _N	S _N	S _B	E _{tk} nom.	C _{dyn}	C _{0stat}
FAG	mm														
B71820-C-TPA-P4	100	125	13	1,00	0,30	105	119,5	1,0	0,3				109,4	21,60	25,00
B71820-E-TPA-P4	100	125	13	1,00	0,30	105	119,5	1,0	0,3				109,4	20,40	23,60
HCB71820-C-TPA-P4	100	125	13	1,00	0,30	105	119,5	1,0	0,3				109,4	15,00	17,60
HCB71820-E-TPA-P4	100	125	13	1,00	0,30	105	119,5	1,0	0,3				109,4	14,00	16,30
B71920-C-T-P4S	100	140	20	1,10	1,10	107	133	0,6	0,6				117,2	58,50	64,00
B71920-E-T-P4S	100	140	20	1,10	1,10	107	133	0,6	0,6				117,2	55,00	60,00
HCB71920-C-T-P4S	100	140	20	1,10	1,10	107	133	0,6	0,6	4,0	12,0	2,2	117,2	40,50	44,00
HCB71920-E-T-P4S	100	140	20	1,10	1,10	107	133	0,6	0,6	4,0	12,0	2,2	117,2	38,00	42,50
XCB71920-C-T-P4S	100	140	20	1,10	1,10	107	133	0,6	0,6	4,0	12,0	2,2	117,2	90,00	44,00
XCB71920-E-T-P4S	100	140	20	1,10	1,10	107	133	0,6	0,6	4,0	12,0	2,2	117,2	85,00	42,50
HS71920-C-T-P4S	100	140	20	1,10		107	133	0,6	0,6				116,7	29,00	36,00
HS71920-E-T-P4S	100	140	20	1,10		107	133	0,6	0,6				116,7	27,50	33,50
HC71920-C-T-P4S	100	140	20	1,10		107	133	0,6	0,6	4,0	12,0	2,2	116,7	20,40	25,00
HC71920-E-T-P4S	100	140	20	1,10		107	133	0,6	0,6	4,0	12,0	2,2	116,7	19,00	23,60
XC71920-C-T-P4S	100	140	20	1,10		107	133	0,6	0,6	4,0	12,0	2,2	116,7	45,50	25,00
XC71920-E-T-P4S	100	140	20	1,10		107	133	0,6	0,6	4,0	12,0	2,2	116,7	42,50	23,60
B7020-C-T-P4S	100	150	24	1,50	1,50	110	141	1,5	0,6				118,6	81,50	81,50
B7020-E-T-P4S	100	150	24	1,50	1,50	110	141	1,5	0,6				118,6	76,50	76,50
HCB7020-C-T-P4S	100	150	24	1,50	1,50	110	141	1,5	0,6	5,5	14,5	2,2	118,6	56,00	56,00
HCB7020-E-T-P4S	100	150	24	1,50	1,50	110	141	1,5	0,6	5,5	14,5	2,2	118,6	53,00	53,00
XCB7020-C-T-P4S	100	150	24	1,50	1,50	110	141	1,5	0,6	5,5	14,5	2,2	118,6	125,00	56,00
XCB7020-E-T-P4S	100	150	24	1,50	1,50	110	141	1,5	0,6	5,5	14,5	2,2	118,6	118,00	53,00
HS7020-C-T-P4S	100	150	24	1,50		110	141	1,5	0,6				121,0	38,00	45,50
HS7020-E-T-P4S	100	150	24	1,50		110	141	1,5	0,6				121,0	36,00	42,50
HC7020-C-T-P4S	100	150	24	1,50		110	141	1,5	0,6	5,5	14,5	2,2	121,0	26,50	31,50
HC7020-E-T-P4S	100	150	24	1,50		110	141	1,5	0,6	5,5	14,5	2,2	121,0	25,00	30,00
XC7020-C-T-P4S	100	150	24	1,50		110	141	1,5	0,6	5,5	14,5	2,2	121,0	58,50	31,50
XC7020-E-T-P4S	100	150	24	1,50		110	141	1,5	0,6	5,5	14,5	2,2	121,0	56,00	30,00
B7220-C-T-P4S	100	180	34	2,10	2,10	114,5	165,5	2,1	2,1				132,4	132,00	122,00
B7220-E-T-P4S	100	180	34	2,10	2,10	114,5	165,5	2,1	2,1				132,4	125,00	116,00
HCB7220-C-T-P4S	100	180	34	2,10	2,10	114,5	165,5	2,1	2,1				132,4	91,50	85,00
HCB7220-E-T-P4S	100	180	34	2,10	2,10	114,5	165,5	2,1	2,1				132,4	86,50	81,50

- * options; • = possible, – = not possible
- ** see section Engineering, Speeds
- *** see section Engineering, Deflection and Rigidity

Designation examples:

Sealed design

B7020-C-2RSD-T-P4S-UL
HSS7020-E-T-P4S-UL

Hybrid ceramic design

HC7020-E-T-P4S-UL
HCB71820-C-TPA-P4-UL

Direct Lube design

HCB7020-EDLR-T-P4S-UL
HC7020-EDLR-T-P4S-UL

B718..C/E, B719, B70, B72 HS719..C/E, HS70

C: Contact angle $\alpha = 15^\circ$
E: Contact angle $\alpha = 25^\circ$

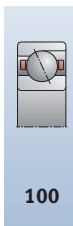
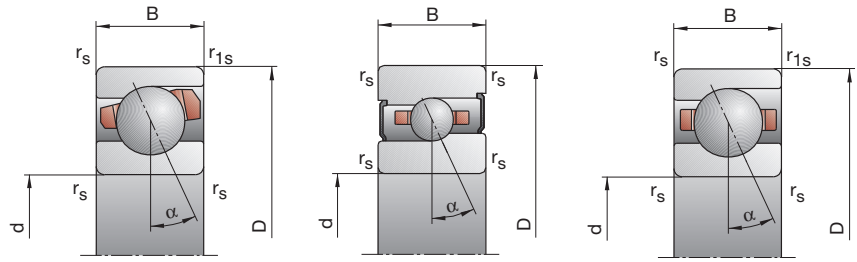

Attainable speed**		Preloading force			Unloading force***			Axial rigidity***			Sealed design*	Weight	Bearing code
Grease	Oil	L	M	H	L	M	H	L	M	H			
min ⁻¹	minimal	N			N/μm			N/μm			kg	FAG	
9500	16000	91	341	735	274	1112	2570	61,2	109,4	160,6	—	0,30	B71820-C-TPA-P4
8500	14000	109	500	1132	313	1483	3464	135,5	237,9	330,4	—	0,30	B71820-E-TPA-P4
12000	19000	46	203	454	136	641	1517	52,8	96,5	139,5	—	0,30	HCB71820-C-TPA-P4
10000	17000	79	272	669	228	801	2016	137,2	213,8	300,7	—	0,30	HCB71820-E-TPA-P4
9000	15000	318	1059	2194	980	3524	7827	94,6	161,7	233,7	•	0,79	B71920-C-T-P4S
8000	13000	453	1626	3437	1323	4902	10706	219,8	355,1	481,6	•	0,79	B71920-E-T-P4S
11000	18000	161	576	1220	488	1841	4106	81,4	136,6	192,3	•	0,66	HCB71920-C-T-P4S
9500	16000	204	852	1881	596	2544	5745	188,0	313,9	424,3	•	0,66	HCB71920-E-T-P4S
15000	24000	161	576	1220	488	1841	4106	81,4	136,6	192,3	•	0,66	XCB71920-C-T-P4S
12000	19000	204	852	1881	596	2544	5745	188,0	313,9	424,3	•	0,66	XCB71920-E-T-P4S
11000	18000	102	306	611	301	947	1978	65,5	102,4	139,7	•	0,90	HS71920-C-T-P4S
9500	16000	166	497	994	476	1447	2950	165,5	245,4	319,2	•	0,90	HS71920-E-T-P4S
13000	20000	70	209	418	207	639	1324	64,4	98,3	131,5	•	0,84	HC71920-C-T-P4S
12000	18000	115	345	690	332	1009	2046	165,4	243,6	314,1	•	0,84	HC71920-E-T-P4S
17000	28000	70	209	418	207	639	1324	64,4	98,3	131,5	•	0,84	XC71920-C-T-P4S
14000	22000	115	345	690	332	1009	2046	165,4	243,6	314,1	•	0,84	XC71920-E-T-P4S
8500	14000	467	1516	3112	1450	5092	11199	104,1	177,2	255,8	•	1,26	B7020-C-T-P4S
7500	12000	685	2347	4902	2009	7114	15314	243,1	387,4	523,6	•	1,26	B7020-E-T-P4S
11000	18000	238	818	1707	723	2632	5787	89,4	148,6	208,5	•	1,05	HCB7020-C-T-P4S
9000	15000	334	1272	2731	980	3815	8366	213,5	345,9	463,5	•	1,05	HCB7020-E-T-P4S
14000	22000	238	818	1707	723	2632	5787	89,4	148,6	208,5	•	1,05	XCB7020-C-T-P4S
12000	19000	334	1272	2731	980	3815	8366	213,5	345,9	463,5	•	1,05	XCB7020-E-T-P4S
12000	18000	134	402	804	397	1250	2618	69,5	108,9	149,0	•	1,40	HS7020-C-T-P4S
9000	15000	215	644	1288	615	1879	3822	173,9	258,6	336,2	•	1,40	HS7020-E-T-P4S
12000	19000	91	273	547	269	837	1736	67,8	104,0	139,4	•	1,29	HC7020-C-T-P4S
12000	18000	148	444	888	428	1297	2631	173,8	255,7	329,8	•	1,29	HC7020-E-T-P4S
16000	26000	91	273	547	269	837	1736	67,8	104,0	139,4	•	1,29	XC7020-C-T-P4S
14000	22000	148	444	888	428	1297	2631	173,8	255,7	329,8	•	1,29	XC7020-E-T-P4S
7500	12000	796	2519	5128	2482	8499	18521	121,7	205,5	295,8	—	3,32	B7220-C-T-P4S
6700	10000	1217	3994	8229	3576	12137	25856	287,0	451,4	608,5	—	3,32	B7220-E-T-P4S
9500	16000	428	1408	2898	1309	4556	9884	106,4	174,6	244,2	—	2,87	HCB7220-C-T-P4S
8000	13000	623	2181	5427	1832	6554	16724	256,2	403,6	548,1	—	2,87	HCB7220-E-T-P4S

X-life ultra design

XCB7020-E-2RSD-T-P4S-UL
XC7020-EDLR-T-P4S-UL

TX design

HCB7020-C-TX-P4S-UL
XC7020-EDLR-TX-P4S-UL

FAG Spindle Bearings

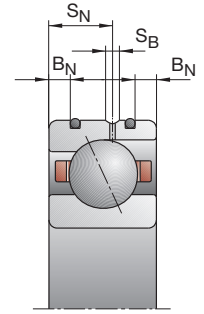
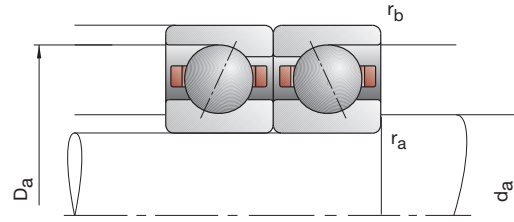
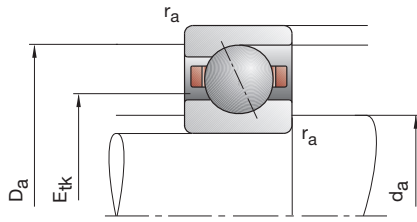

Bearing code	Dimensions					Abutment dimensions				DLR dimensions			Load rating		
	d	D	B	r _{smin}	r _{1smin}	d _a	D _a	r _a	r _b	B _N	S _N	S _B	E _{tk} nom.	C _{dyn}	C _{0stat}
FAG	mm														
B71821-C-TPA-P4	105	130	13	1,00	0,30	110	124,5	1,0	0,3				114,4	22,80	27,50
B71821-E-TPA-P4	105	130	13	1,00	0,30	110	124,5	1,0	0,3				114,4	21,60	25,50
HCB71821-C-TPA-P4	105	130	13	1,00	0,30	110	124,5	1,0	0,3				114,4	15,60	19,00
HCB71821-E-TPA-P4	105	130	13	1,00	0,30	110	124,5	1,0	0,3				114,4	15,00	18,00
B71921-C-T-P4S	105	145	20	1,10	1,10	112	138	0,6	0,6				121,2	58,50	64,00
B71921-E-T-P4S	105	145	20	1,10	1,10	112	138	0,6	0,6				121,2	55,00	60,00
HCB71921-C-T-P4S	105	145	20	1,10	1,10	112	138	0,6	0,6	4,0	12,0	2,2	121,2	40,00	45,00
HCB71921-E-T-P4S	105	145	20	1,10	1,10	112	138	0,6	0,6	4,0	12,0	2,2	121,2	38,00	42,50
XCB71921-C-T-P4S	105	145	20	1,10	1,10	112	138	0,6	0,6	4,0	12,0	2,2	121,2	90,00	45,00
XCB71921-E-T-P4S	105	145	20	1,10	1,10	112	138	0,6	0,6	4,0	12,0	2,2	121,2	85,00	42,50
HS71921-C-T-P4S	105	145	20	1,10		112	138	0,6	0,6				121,7	30,00	38,00
HS71921-E-T-P4S	105	145	20	1,10		112	138	0,6	0,6				121,7	28,00	35,50
HC71921-C-T-P4S	105	145	20	1,10		112	138	0,6	0,6	4,0	12,0	2,2	121,7	20,80	26,50
HC71921-E-T-P4S	105	145	20	1,10		112	138	0,6	0,6	4,0	12,0	2,2	121,7	19,60	24,50
XC71921-C-T-P4S	105	145	20	1,10		112	138	0,6	0,6	4,0	12,0	2,2	121,7	46,50	26,50
XC71921-E-T-P4S	105	145	20	1,10		112	138	0,6	0,6	4,0	12,0	2,2	121,7	44,00	24,50
B7021-C-T-P4S	105	160	26	2,00	2,00	116	150	2,0	1,0				125,8	106,00	102,00
B7021-E-T-P4S	105	160	26	2,00	2,00	116	150	2,0	1,0				125,8	102,00	98,00
HCB7021-C-T-P4S	105	160	26	2,00	2,00	116	150	2,0	1,0	6,0	15,2	2,2	125,8	73,50	72,00
HCB7021-E-T-P4S	105	160	26	2,00	2,00	116	150	2,0	1,0	6,0	15,2	2,2	125,8	69,50	68,00
XCB7021-C-T-P4S	105	160	26	2,00	2,00	116	150	2,0	1,0	6,0	15,2	2,2	125,8	163,00	72,00
XCB7021-E-T-P4S	105	160	26	2,00	2,00	116	150	2,0	1,0	6,0	15,2	2,2	125,8	156,00	68,00
HS7021-C-T-P4S	105	160	26	2,00		116	150	2,0	1,0				127,9	49,00	58,50
HS7021-E-T-P4S	105	160	26	2,00		116	150	2,0	1,0				127,9	46,50	54,00
HC7021-C-T-P4S	105	160	26	2,00		116	150	2,0	1,0	6,0	15,2	2,2	127,9	34,00	40,50
HC7021-E-T-P4S	105	160	26	2,00		116	150	2,0	1,0	6,0	15,2	2,2	127,9	32,00	38,00
XC7021-C-T-P4S	105	160	26	2,00		116	150	2,0	1,0	6,0	15,2	2,2	127,9	76,50	40,50
XC7021-E-T-P4S	105	160	26	2,00		116	150	2,0	1,0	6,0	15,2	2,2	127,9	71,00	38,00
B7221-C-T-P4S	105	190	36	2,10	2,10	120,5	174,5	2,1	2,1				139,9	163,00	146,00
B7221-E-T-P4S	105	190	36	2,10	2,10	120,5	174,5	2,1	2,1				139,9	156,00	140,00
HCB7221-C-T-P4S	105	190	36	2,10	2,10	120,5	174,5	2,1	2,1				139,9	112,00	102,00
HCB7221-E-T-P4S	105	190	36	2,10	2,10	120,5	174,5	2,1	2,1				139,9	106,00	98,00

- * options; • = possible, – = not possible
- ** see section Engineering, Speeds
- *** see section Engineering, Deflection and Rigidity

Designation examples:

Sealed design

B7021-C-2RSD-T-P4S-UL
HSS7021-E-T-P4S-UL

Hybrid ceramic design

HC7021-E-T-P4S-UL
HCB71821-C-TPA-P4-UL

Direct Lube design

HCB7021-EDLR-T-P4S-UL
HC7021-EDLR-T-P4S-UL

B718..C/E, B719, B70, B72 HS719..C/E, HS70

C: Contact angle $\alpha = 15^\circ$
E: Contact angle $\alpha = 25^\circ$

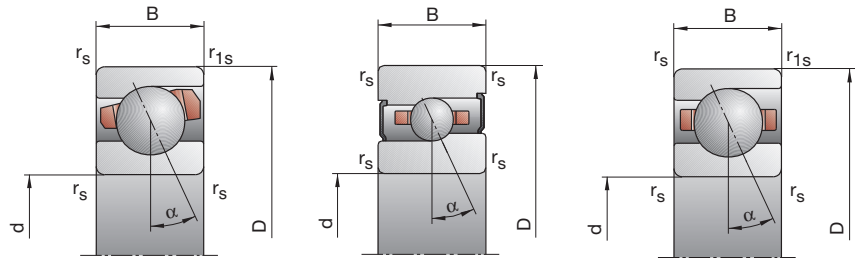

Attainable speed**		Preloading force			Unloading force***			Axial rigidity***			Sealed design*	Weight	Bearing code
Grease min ⁻¹	Oil minimal	F _V			K _{aE}			c _a					
		L	M	H	L	M	H	L	M	H	kg	FAG	
9000	15000	95	358	774	286	1164	2696	65,9	117,3	172,2	—	0,3	B71821-C-TPA-P4
8000	13000	112	525	1193	321	1555	3644	144,8	256,0	355,8	—	0,3	B71821-E-TPA-P4
12000	19000	47	209	470	139	658	1563	56,4	102,9	148,6	—	0,3	HCB71821-C-TPA-P4
10000	17000	80	278	686	231	817	2062	146,2	227,9	320,5	—	0,3	HCB71821-E-TPA-P4
8500	14000	318	1059	2194	980	3524	7826	94,6	161,7	233,7	•	0,8	B71921-C-T-P4S
7500	12000	453	1626	3437	1323	4902	10705	219,8	355,1	481,6	•	0,8	B71921-E-T-P4S
11000	18000	161	576	1220	487	1840	4105	81,2	136,6	192,3	•	0,7	HCB71921-C-T-P4S
9000	15000	204	852	1881	596	2543	5745	188,0	313,8	424,3	•	0,7	HCB71921-E-T-P4S
14000	22000	161	576	1220	487	1840	4105	81,2	136,6	192,3	•	0,7	XCB71921-C-T-P4S
12000	19000	204	852	1881	596	2543	5745	188,0	313,8	424,3	•	0,7	XCB71921-E-T-P4S
12000	18000	104	311	622	307	961	2008	68,3	106,4	144,9	•	0,9	HS71921-C-T-P4S
9000	15000	169	506	1012	484	1472	2999	172,2	255,3	331,8	•	0,9	HS71921-E-T-P4S
12000	19000	71	214	429	209	653	1357	66,7	102,3	137,0	•	0,9	HC71921-C-T-P4S
12000	18000	117	352	704	337	1029	2086	171,9	253,8	327,1	•	0,9	HC71921-E-T-P4S
16000	26000	71	214	429	209	653	1357	66,7	102,3	137,0	•	0,9	XC71921-C-T-P4S
14000	22000	117	352	704	337	1029	2086	171,9	253,8	327,1	•	0,9	XC71921-E-T-P4S
8000	13000	625	1999	4083	1942	6714	14681	114,3	193,4	278,6	•	1,6	B7021-C-T-P4S
7000	11000	960	3206	6639	2816	9723	20806	270,9	428,4	578,2	•	1,6	B7021-E-T-P4S
10000	17000	337	1125	2328	1028	3629	7914	100,3	165,2	231,3	•	1,3	HCB7021-C-T-P4S
8500	14000	470	1703	3618	1383	5119	11103	238,4	379,6	506,8	•	1,3	HCB7021-E-T-P4S
13000	20000	337	1125	2328	1028	3629	7914	100,3	165,2	231,3	•	1,3	XCB7021-C-T-P4S
11000	18000	470	1703	3618	1383	5119	11103	238,4	379,6	506,8	•	1,3	XCB7021-E-T-P4S
10000	17000	170	509	1018	504	1580	3317	75,9	118,7	162,4	•	1,8	HS7021-C-T-P4S
8500	14000	276	828	1656	790	2412	4919	190,6	283,4	368,9	•	1,8	HS7021-E-T-P4S
12000	19000	118	355	710	350	1088	2259	74,8	114,6	153,8	•	1,6	HC7021-C-T-P4S
11000	17000	192	575	1150	555	1682	3412	191,0	281,3	362,9	•	1,6	HC7021-E-T-P4S
15000	24000	118	355	710	350	1088	2259	74,8	114,6	153,8	•	1,6	XC7021-C-T-P4S
13000	21000	192	575	1150	555	1682	3412	191,0	281,3	362,9	•	1,6	XC7021-E-T-P4S
7000	11000	997	3140	6377	3116	10597	23098	132,0	222,4	320,4	—	4,0	B7221-C-T-P4S
6300	9500	1558	5040	10337	4587	15335	32479	313,5	490,7	660,3	—	4,0	B7221-E-T-P4S
9000	15000	535	1734	3559	1635	5604	12126	115,2	187,9	262,4	—	3,3	HCB7221-C-T-P4S
7500	12000	805	2756	5751	2371	8297	17714	280,6	438,8	583,1	—	3,3	HCB7221-E-T-P4S

X-life ultra design

XCB7021-E-2RSD-T-P4S-UL
XC7021-EDLR-T-P4S-UL

TX design

HCB7021-C-TX-P4S-UL
XC7021-EDLR-TX-P4S-UL

FAG Spindle Bearings

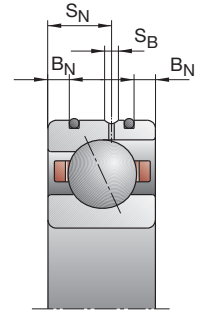
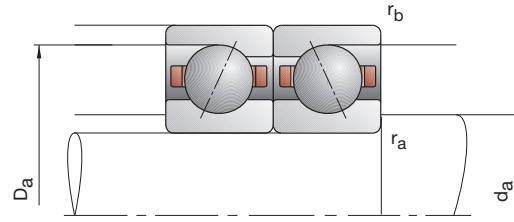
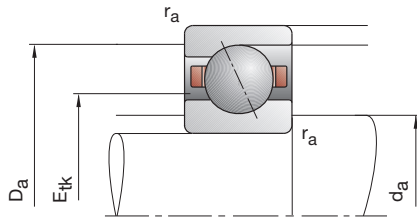

Bearing code	Dimensions					Abutment dimensions				DLR dimensions			Load rating		
	d	D	B	r _{smin}	r _{1smin}	d _a	D _a	r _a	r _b	B _N	S _N	S _B	E _{tk} nom.	C _{dyn}	C _{0stat}
FAG	mm														
B71822-C-TPA-P4	110	140	16	1,00	0,30	116	133,5	1,0	0,3				121,2	31,50	36,50
B71822-E-TPA-P4	110	140	16	1,00	0,30	116	133,5	1,0	0,3				121,2	29,00	34,00
HCB71822-C-TPA-P4	110	140	16	1,00	0,30	116	133,5	1,0	0,3				121,2	21,60	25,50
HCB71822-E-TPA-P4	110	140	16	1,00	0,30	116	133,5	1,0	0,3				121,2	20,40	24,00
B71922-C-T-P4S	110	150	20	1,10	1,10	117	143	0,6	0,6				126,2	58,50	67,00
B71922-E-T-P4S	110	150	20	1,10	1,10	117	143	0,6	0,6				126,2	56,00	63,00
HCB71922-C-T-P4S	110	150	20	1,10	1,10	117	143	0,6	0,6	4,0	12,0	2,2	126,2	40,50	46,50
HCB71922-E-T-P4S	110	150	20	1,10	1,10	117	143	0,6	0,6	4,0	12,0	2,2	126,2	39,00	44,00
XCB71922-C-T-P4S	110	150	20	1,10	1,10	117	143	0,6	0,6	4,0	12,0	2,2	126,2	90,00	46,50
XCB71922-E-T-P4S	110	150	20	1,10	1,10	117	143	0,6	0,6	4,0	12,0	2,2	126,2	86,50	44,00
HS71922-C-T-P4S	110	150	20	1,10		117	143	0,6	0,6				126,4	34,50	44,00
HS71922-E-T-P4S	110	150	20	1,10		117	143	0,6	0,6				126,4	32,50	40,50
HC71922-C-T-P4S	110	150	20	1,10		117	143	0,6	0,6	4,0	12,0	2,2	126,4	24,00	30,50
HC71922-E-T-P4S	110	150	20	1,10		117	143	0,6	0,6	4,0	12,0	2,2	126,4	22,80	28,50
XC71922-C-T-P4S	110	150	20	1,10		117	143	0,6	0,6	4,0	12,0	2,2	126,4	54,00	30,50
XC71922-E-T-P4S	110	150	20	1,10		117	143	0,6	0,6	4,0	12,0	2,2	126,4	51,00	28,50
B7022-C-T-P4S	110	170	28	2,00	2,00	121	159	2,0	1,0				133,3	110,00	110,00
B7022-E-T-P4S	110	170	28	2,00	2,00	121	159	2,0	1,0				133,3	104,00	104,00
HCB7022-C-T-P4S	110	170	28	2,00	2,00	121	159	2,0	1,0	6,0	16,2	2,2	133,3	75,00	76,50
HCB7022-E-T-P4S	110	170	28	2,00	2,00	121	159	2,0	1,0	6,0	16,2	2,2	133,3	72,00	72,00
XCB7022-C-T-P4S	110	170	28	2,00	2,00	121	159	2,0	1,0	6,0	16,2	2,2	133,3	166,00	76,50
XCB7022-E-T-P4S	110	170	28	2,00	2,00	121	159	2,0	1,0	6,0	16,2	2,2	133,3	160,00	72,00
HS7022-C-T-P4S	110	170	28	2,00		121	159	2,0	1,0				135,4	50,00	60,00
HS7022-E-T-P4S	110	170	28	2,00		121	159	2,0	1,0				135,4	46,50	56,00
HC7022-C-T-P4S	110	170	28	2,00		121	159	2,0	1,0	6,0	16,2	2,2	135,4	34,50	41,50
HC7022-E-T-P4S	110	170	28	2,00		121	159	2,0	1,0	6,0	16,2	2,2	135,4	32,50	39,00
XC7022-C-T-P4S	110	170	28	2,00		121	159	2,0	1,0	6,0	16,2	2,2	135,4	76,50	41,50
XC7022-E-T-P4S	110	170	28	2,00		121	159	2,0	1,0	6,0	16,2	2,2	135,4	72,00	39,00
B7222-C-T-P4S	110	200	38	2,10	2,10	126,5	183,5	2,1	2,1				147,4	163,00	150,00
B7222-E-T-P4S	110	200	38	2,10	2,10	126,5	183,5	2,1	2,1				147,4	153,00	143,00
HCB7222-C-T-P4S	110	200	38	2,10	2,10	126,5	183,5	2,1	2,1				147,4	112,00	104,00
HCB7222-E-T-P4S	110	200	38	2,10	2,10	126,5	183,5	2,1	2,1				147,4	106,00	98,00

- * options; • = possible, – = not possible
- ** see section Engineering, Speeds
- *** see section Engineering, Deflection and Rigidity

Designation examples:

Sealed design

B7022-C-2RSD-T-P4S-UL
HSS7022-E-T-P4S-UL

Hybrid ceramic design

HC7022-E-T-P4S-UL
HCB71822-C-TPA-P4-UL

Direct Lube design

HCB7022-EDLR-T-P4S-UL
HC7022-EDLR-T-P4S-UL

B718..C/E, B719, B70, B72 HS719..C/E, HS70

C: Contact angle $\alpha = 15^\circ$
E: Contact angle $\alpha = 25^\circ$

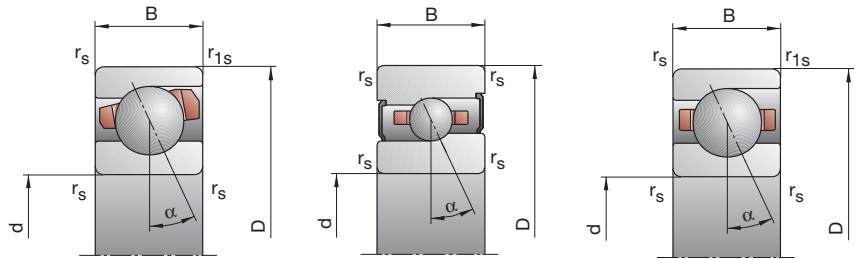

Attainable speed**		Preloading force F_V			Unloading force*** K_{aE}			Axial rigidity*** c_a			Sealed design*	Weight kg	Bearing code FAG
Grease	Oil	L	M	H	L	M	H	L	M	H			
min ⁻¹	minimal	N			N/μm			N/μm					
8 500	14 000	146	521	1 105	445	1 721	3 917	77,1	135,8	198,7	—	0,5	B71822-C-TPA-P4
7 500	12 000	181	757	1 673	522	2 259	5 156	170,6	291,1	401,7	—	0,5	B71822-E-TPA-P4
11 000	18 000	79	315	690	237	1 006	2 334	68,0	120,1	172,8	—	0,5	HCB71822-C-TPA-P4
9 000	15 000	83	445	1 042	240	1 320	3 173	147,3	268,8	372,7	—	0,5	HCB71822-E-TPA-P4
8 000	13 000	316	1 056	2 191	972	3 501	7 781	96,5	164,8	237,9	•	0,8	B71922-C-T-P4S
7 500	12 000	458	1 651	3 495	1 337	4 973	10 873	226,3	365,8	496,2	•	0,8	B71922-E-T-P4S
10 000	17 000	163	583	1 236	493	1 860	4 150	83,7	140,4	197,5	•	0,7	HCB71922-C-T-P4S
9 000	15 000	205	861	1 905	599	2 569	5 813	193,3	323,0	436,8	•	0,7	HCB71922-E-T-P4S
13 000	20 000	163	583	1 236	493	1 860	4 150	83,7	140,4	197,5	•	0,7	XCB71922-C-T-P4S
11 000	18 000	205	861	1 905	599	2 569	5 813	193,3	323,0	436,8	•	0,7	XCB71922-E-T-P4S
10 000	17 000	121	362	724	357	1 120	2 342	71,5	111,7	152,3	•	1,0	HS71922-C-T-P4S
8 500	14 000	196	587	1 173	560	1 709	3 480	180,2	267,6	347,7	•	1,0	HS71922-E-T-P4S
12 000	19 000	83	249	498	245	761	1 573	70,2	107,4	143,6	•	0,9	HC71922-C-T-P4S
11 000	17 000	135	405	810	390	1 185	2 395	180,2	265,2	341,3	•	0,9	HC71922-E-T-P4S
15 000	24 000	83	249	498	245	761	1 573	70,2	107,4	143,6	•	0,9	XC71922-C-T-P4S
13 000	20 000	135	405	810	390	1 185	2 395	180,2	265,2	341,3	•	0,9	XC71922-E-T-P4S
7 500	12 000	648	2 072	4 235	2 011	6 949	15 201	119,6	202,1	290,9	•	2,0	B7022-C-T-P4S
6 700	10 000	975	3 262	6 760	2 857	9 878	21 147	281,3	444,8	600,0	•	2,0	B7022-E-T-P4S
9 500	16 000	340	1 140	2 363	1 035	3 667	8 007	103,8	170,9	239,2	•	1,7	HCB7022-C-T-P4S
8 000	13 000	479	1 742	3 707	1 408	5 232	11 364	248,0	395,3	527,8	•	1,7	HCB7022-E-T-P4S
12 000	19 000	340	1 140	2 363	1 035	3 667	8 007	103,8	170,9	239,2	•	1,7	XCB7022-C-T-P4S
10 000	17 000	479	1 742	3 707	1 408	5 232	11 364	248,0	395,3	527,8	•	1,7	XCB7022-E-T-P4S
9 500	16 000	174	523	1 045	516	1 623	3 403	78,2	122,3	167,3	•	2,2	HS7022-C-T-P4S
8 000	13 000	280	840	1 679	802	2 446	4 984	195,8	290,9	378,4	•	2,2	HS7022-E-T-P4S
11 000	18 000	118	355	710	349	1 086	2 254	76,2	116,8	156,6	•	2,1	HC7022-C-T-P4S
9 500	15 000	192	575	1 150	555	1 681	3 409	195,2	287,3	370,4	•	2,1	HC7022-E-T-P4S
14 000	22 000	118	355	710	349	1 086	2 254	76,2	116,8	156,6	•	2,1	XC7022-C-T-P4S
12 000	19 000	192	575	1 150	555	1 681	3 409	195,2	287,3	370,4	•	2,1	XC7022-E-T-P4S
6 700	10 000	997	3 139	6 376	3 115	10 591	23 087	132,0	222,4	320,3	—	4,7	B7222-C-T-P4S
6 000	9 000	1 525	4 939	10 131	4 487	15 015	31 793	311,0	486,8	654,6	—	4,7	B7222-E-T-P4S
8 500	14 000	535	1 734	3 558	1 635	5 602	12 118	115,2	187,8	262,3	—	4,0	HCB7222-C-T-P4S
7 000	11 000	789	2 705	5 648	2 322	8 137	17 383	278,5	435,7	578,9	—	4,0	HCB7222-E-T-P4S

X-life ultra design

XCB7022-E-2RSD-T-P4S-UL
XC7022-EDLR-T-P4S-UL

TX design

HCB7022-C-TX-P4S-UL
XC7022-EDLR-TX-P4S-UL

FAG Spindle Bearings

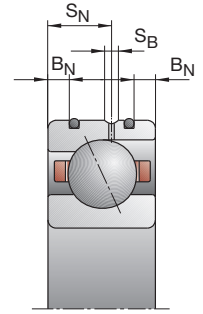
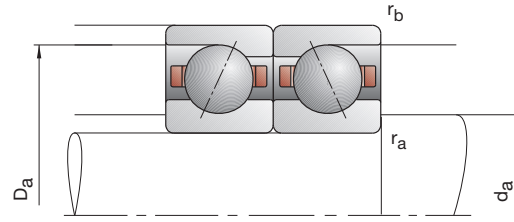
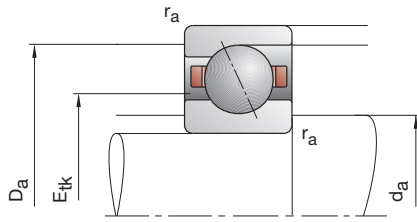

Bearing code	Dimensions					Abutment dimensions				DLR dimensions			Load rating		
	d	D	B	r _{smin}	r _{1smin}	d _a	D _a	r _a	r _b	B _N	S _N	S _B	E _{tk} nom.	C _{dyn}	C _{0stat}
FAG	mm														
B71824-C-TPA-P4	120	150	16	1,00	0,30	126	143,5	1,0	0,3				131,2	32,00	39,00
B71824-E-TPA-P4	120	150	16	1,00	0,30	126	143,5	1,0	0,3				131,2	30,00	36,00
HCB71824-C-TPA-P4	120	150	16	1,00	0,30	126	143,5	1,0	0,3				131,2	22,00	27,00
HCB71824-E-TPA-P4	120	150	16	1,00	0,30	126	143,5	1,0	0,3				131,2	20,80	25,00
B71924-C-T-P4S	120	165	22	1,10	1,10	128	157	0,6	0,6				138,2	73,50	85,00
B71924-E-T-P4S	120	165	22	1,10	1,10	128	157	0,6	0,6				138,2	69,50	80,00
HCB71924-C-T-P4S	120	165	22	1,10	1,10	128	157	0,6	0,6				138,2	51,00	58,50
HCB71924-E-T-P4S	120	165	22	1,10	1,10	128	157	0,6	0,6				138,2	48,00	55,00
XCB71924-C-T-P4S	120	165	22	1,10	1,10	128	157	0,6	0,6				138,2	114,00	58,50
XCB71924-E-T-P4S	120	165	22	1,10	1,10	128	157	0,6	0,6				138,2	108,00	55,00
HS71924-C-T-P4S	120	165	22	1,10		128	157	0,6	0,6				138,9	36,50	48,00
HS71924-E-T-P4S	120	165	22	1,10		128	157	0,6	0,6				138,9	34,00	45,00
HC71924-C-T-P4S	120	165	22	1,10		128	157	0,6	0,6				138,9	25,00	33,50
HC71924-E-T-P4S	120	165	22	1,10		128	157	0,6	0,6				138,9	23,60	31,00
XC71924-C-T-P4S	120	165	22	1,10		128	157	0,6	0,6				138,9	56,00	33,50
XC71924-E-T-P4S	120	165	22	1,10		128	157	0,6	0,6				138,9	53,00	31,00
B7024-C-T-P4S	120	180	28	2,00	2,00	131	169	2,0	1,0				143,3	112,00	116,00
B7024-E-T-P4S	120	180	28	2,00	2,00	131	169	2,0	1,0				143,3	106,00	110,00
HCB7024-C-T-P4S	120	180	28	2,00	2,00	131	169	2,0	1,0				143,3	78,00	81,50
HCB7024-E-T-P4S	120	180	28	2,00	2,00	131	169	2,0	1,0				143,3	73,50	76,50
XCB7024-C-T-P4S	120	180	28	2,00	2,00	131	169	2,0	1,0				143,3	173,00	81,50
XCB7024-E-T-P4S	120	180	28	2,00	2,00	131	169	2,0	1,0				143,3	163,00	76,50
HS7024-C-T-P4S	120	180	28	2,00		131	169	2,0	1,0				145,4	51,00	63,00
HS7024-E-T-P4S	120	180	28	2,00		131	169	2,0	1,0				145,4	48,00	58,50
HC7024-C-T-P4S	120	180	28	2,00		131	169	2,0	1,0				145,4	35,50	44,00
HC7024-E-T-P4S	120	180	28	2,00		131	169	2,0	1,0				145,4	33,50	41,50
XC7024-C-T-P4S	120	180	28	2,00		131	169	2,0	1,0				145,4	80,00	44,00
XC7024-E-T-P4S	120	180	28	2,00		131	169	2,0	1,0				145,4	75,00	41,50
B7224-C-T-P4S	120	215	40	2,10	2,10	140	195	2,1	2,1				158,0	204,00	196,00
B7224-E-T-P4S	120	215	40	2,10	2,10	140	195	2,1	2,1				158,0	196,00	186,00
HCB7224-C-T-P4S	120	215	40	2,10	2,10	140	195	2,1	2,1				158,0	140,00	137,00
HCB7224-E-T-P4S	120	215	40	2,10	2,10	140	195	2,1	2,1				158,0	134,00	129,00

- * options; • = possible, – = not possible
- ** see section Engineering, Speeds
- *** see section Engineering, Deflection and Rigidity

Designation examples:

Sealed design

B7024-C-2RSD-T-P4S-UL
HSS7024-E-T-P4S-UL

Hybrid ceramic design

HC7024-E-T-P4S-UL
HCB71824-C-TPA-P4-UL

X-life ultra design

XCB7024-E-2RSD-T-P4S-UL
XC7024-E-T-P4S-UL

B718..C/E, B719, B70, B72 HS719..C/E, HS70

C: Contact angle $\alpha = 15^\circ$
E: Contact angle $\alpha = 25^\circ$

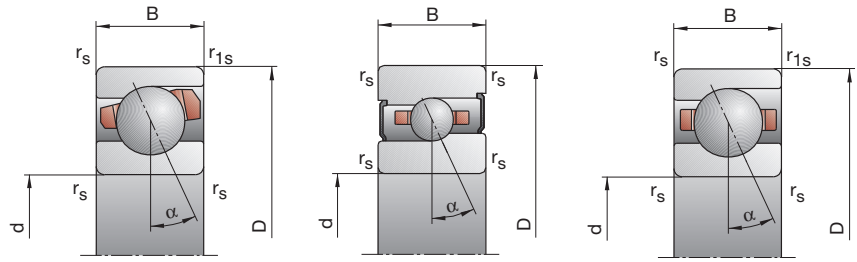

Attainable speed**		Preloading force F_V			Unloading force*** K_{aE}			Axial rigidity*** c_a			Sealed design*	Weight	Bearing code	
Grease	Oil	L	M	H	L	M	H	L	M	H		kg	FAG	
minimal														
min ⁻¹		N												
											N/μm			
7 500	12 000	146	527	1 119	445	1 734	3 956	80,1	141,0	206,3	—	0,5	B71824-C-TPA-P4	
7 000	11 000	184	779	1 725	530	2 323	5 308	178,5	305,9	421,9	—	0,5	B71824-E-TPA-P4	
10 000	17 000	79	319	700	237	1 015	2 358	70,8	125,0	179,7	—	0,5	HCB71824-C-TPA-P4	
8 500	14 000	80	445	1 049	231	1 318	3 188	151,4	279,6	388,1	—	0,5	HCB71824-E-TPA-P4	
7 000	11 000	408	1 344	2 773	1 257	4 462	9 838	109,5	186,0	267,5	•	1,2	B71924-C-T-P4S	
6 700	10 000	591	2 087	4 388	1 726	6 291	13 620	256,2	411,5	555,9	•	1,2	B71924-E-T-P4S	
9 000	15 000	212	742	1 566	642	2 370	5 263	95,1	158,4	222,4	•	1,0	HCB71924-C-T-P4S	
8 000	13 000	277	1 110	2 421	811	3 315	7 395	222,7	365,9	492,3	•	1,0	HCB71924-E-T-P4S	
12 000	19 000	212	742	1 566	642	2 370	5 263	95,1	158,4	222,4	•	1,0	XCB71924-C-T-P4S	
10 000	17 000	277	1 110	2 421	811	3 315	7 395	222,7	365,9	492,3	•	1,0	XCB71924-E-T-P4S	
9 000	15 000	127	382	764	374	1 179	2 462	77,6	121,2	164,9	•	1,3	HS71924-C-T-P4S	
8 000	13 000	207	621	1 242	591	1 806	3 680	196,3	291,4	378,6	•	1,3	HS71924-E-T-P4S	
11 000	18 000	88	263	525	260	802	1 654	76,7	116,7	155,7	•	1,3	HC71924-C-T-P4S	
9 500	15 000	143	428	856	413	1 248	2 528	196,6	288,6	371,6	•	1,3	HC71924-E-T-P4S	
14 000	22 000	88	263	525	260	802	1 654	76,7	116,7	155,7	•	1,3	XC71924-C-T-P4S	
12 000	19 000	143	428	856	413	1 248	2 528	196,6	288,6	371,6	•	1,3	XC71924-E-T-P4S	
6 700	10 000	657	2 107	4 308	2 035	7 046	15 410	123,7	208,9	300,3	•	2,1	B7024-C-T-P4S	
6 300	9 500	989	3 317	6 881	2 896	10 031	21 490	291,7	461,2	621,8	•	2,1	B7024-E-T-P4S	
8 500	14 000	351	1 175	2 437	1 068	3 775	8 244	108,3	178,0	248,9	•	1,8	HCB7024-C-T-P4S	
7 500	12 000	488	1 782	3 795	1 434	5 334	11 621	257,6	410,6	548,6	•	1,8	HCB7024-E-T-P4S	
11 000	18 000	351	1 175	2 437	1 068	3 775	8 244	108,3	178,0	248,9	•	1,8	XCB7024-C-T-P4S	
9 500	16 000	488	1 782	3 795	1 434	5 334	11 621	257,6	410,6	548,6	•	1,8	XCB7024-E-T-P4S	
8 500	14 000	179	536	1 072	530	1 659	3 480	82,1	128,0	175,0	•	2,3	HS7024-C-T-P4S	
7 500	12 000	288	863	1 725	824	2 511	5 114	205,8	305,6	397,2	•	2,3	HS7024-E-T-P4S	
10 000	17 000	123	369	737	363	1 128	2 336	80,5	123,2	164,9	•	2,1	HC7024-C-T-P4S	
9 000	14 000	199	598	1 196	575	1 747	3 543	205,8	303,1	390,8	•	2,1	HC7024-E-T-P4S	
13 000	20 000	123	369	737	363	1 128	2 336	80,5	123,2	164,9	•	2,1	XC7024-C-T-P4S	
11 000	18 000	199	598	1 196	575	1 747	3 543	205,8	303,1	390,8	•	2,1	XC7024-E-T-P4S	
6 000	9 000	1 269	3 957	8 038	3 947	13 275	28 900	140,0	233,9	335,7	—	5,5	B7224-C-T-P4S	
5 300	8 000	2 003	6 418	13 107	5 898	19 505	41 076	335,4	522,0	699,7	—	5,5	B7224-E-T-P4S	
7 500	12 000	684	2 190	4 478	2 088	7 051	15 167	122,8	198,5	275,8	—	4,4	HCB7224-C-T-P4S	
6 300	9 500	1 047	3 506	7 288	3 085	10 550	22 362	301,6	467,4	618,6	—	4,4	HCB7224-E-T-P4S	

FAG Spindle Bearings

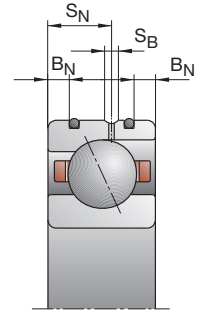
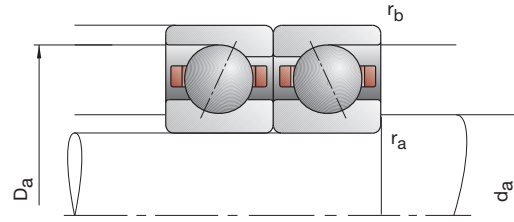
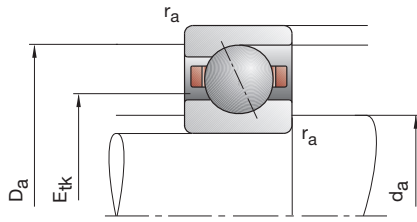

Bearing code	Dimensions					Abutment dimensions				DLR dimensions			Load rating			
	d	D	B	r _{smin}	r _{1smin}	d _a	D _a	r _a	r _b	B _N	S _N	S _B	E _{tk} nom.	C _{dyn}	C _{0stat}	
FAG	mm														kN	
B71826-C-TPA-P4	130	165	18	1,10	0,60	137	158	1,1	0,6				143,1	42,50	51,00	
B71826-E-TPA-P4	130	165	18	1,10	0,60	137	158	1,1	0,6				143,1	40,00	48,00	
HCB71826-C-TPA-P4	130	165	18	1,10	0,60	137	158	1,1	0,6				143,1	29,00	35,50	
HCB71826-E-TPA-P4	130	165	18	1,10	0,60	137	158	1,1	0,6				143,1	27,50	33,50	
B71926-C-T-P4S	130	180	24	1,50	1,50	139	171	0,6	0,6				150,2	86,50	100,00	
B71926-E-T-P4S	130	180	24	1,50	1,50	139	171	0,6	0,6				150,2	81,50	95,00	
HCB71926-C-T-P4S	130	180	24	1,50	1,50	139	171	0,6	0,6				150,2	60,00	69,50	
HCB71926-E-T-P4S	130	180	24	1,50	1,50	139	171	0,6	0,6				150,2	57,00	65,50	
XCB71926-C-T-P4S	130	180	24	1,50	1,50	139	171	0,6	0,6				150,2	134,00	69,50	
XCB71926-E-T-P4S	130	180	24	1,50	1,50	139	171	0,6	0,6				150,2	127,00	65,50	
HS71926-C-T-P4S	130	180	24	1,50		139	171	0,6	0,6				151,0	41,50	56,00	
HS71926-E-T-P4S	130	180	24	1,50		139	171	0,6	0,6				151,0	39,00	52,00	
HC71926-C-T-P4S	130	180	24	1,50		139	171	0,6	0,6				151,0	29,00	39,00	
HC71926-E-T-P4S	130	180	24	1,50		139	171	0,6	0,6				151,0	27,00	36,50	
XC71926-C-T-P4S	130	180	24	1,50		139	171	0,6	0,6				151,0	64,00	39,00	
XC71926-E-T-P4S	130	180	24	1,50		139	171	0,6	0,6				151,0	60,00	36,50	
B7026-C-T-P4S	130	200	33	2,00	2,00	142	189	2,0	1,0				157,2	143,00	150,00	
B7026-E-T-P4S	130	200	33	2,00	2,00	142	189	2,0	1,0				157,2	137,00	143,00	
HCB7026-C-T-P4S	130	200	33	2,00	2,00	142	189	2,0	1,0				157,2	100,00	104,00	
HCB7026-E-T-P4S	130	200	33	2,00	2,00	142	189	2,0	1,0				157,2	95,00	98,00	
XCB7026-C-T-P4S	130	200	33	2,00	2,00	142	189	2,0	1,0				157,2	224,00	104,00	
XCB7026-E-T-P4S	130	200	33	2,00	2,00	142	189	2,0	1,0				157,2	212,00	98,00	
HS7026-C-T-P4S	130	200	33	2,00		142	189	2,0	1,0				159,7	65,50	83,00	
HS7026-E-T-P4S	130	200	33	2,00		142	189	2,0	1,0				159,7	62,00	78,00	
HC7026-C-T-P4S	130	200	33	2,00		142	189	2,0	1,0				159,7	45,50	58,50	
HC7026-E-T-P4S	130	200	33	2,00		142	189	2,0	1,0				159,7	42,50	54,00	
XC7026-C-T-P4S	130	200	33	2,00		142	189	2,0	1,0				159,7	102,00	58,50	
XC7026-E-T-P4S	130	200	33	2,00		142	189	2,0	1,0				159,7	95,00	54,00	
B7226-C-T-P4S	130	230	40	3,00	3,00	148	211,5	2,5	2,5				170,5	212,00	216,00	
B7226-E-T-P4S	130	230	40	3,00	3,00	148	211,5	2,5	2,5				170,5	204,00	204,00	
HCB7226-C-T-P4S	130	230	40	3,00	3,00	148	211,5	2,5	2,5				170,5	146,00	150,00	
HCB7226-E-T-P4S	130	230	40	3,00	3,00	148	211,5	2,5	2,5				170,5	140,00	143,00	

- * options; • = possible, – = not possible
- ** see section Engineering, Speeds
- *** see section Engineering, Deflection and Rigidity

Designation examples:

Sealed design

B7026-C-2RSD-T-P4S-UL
HSS7026-E-T-P4S-UL

Hybrid ceramic design

HC7026-E-T-P4S-UL
HCB71826-C-TPA-P4-UL

X-life ultra design

XCB7026-E-2RSD-T-P4S-UL
XC7026-E-T-P4S-UL

B718..C/E, B719, B70, B72 HS719..C/E, HS70

C: Contact angle $\alpha = 15^\circ$
E: Contact angle $\alpha = 25^\circ$

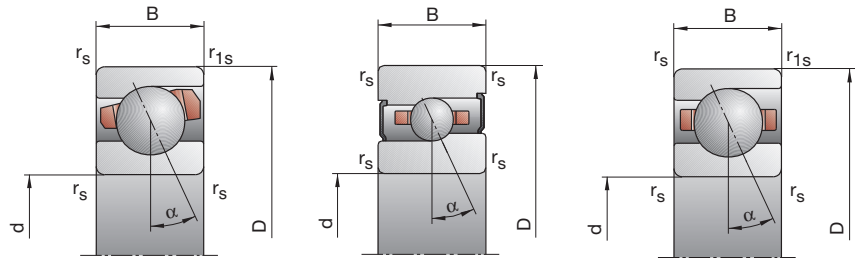

Attainable speed**		Preloading force			Unloading force***			Axial rigidity***			Sealed design*	Weight	Bearing code
Grease	Oil	L	M	H	L	M	H	L	M	H			
min ⁻¹	minimal	N			N/μm			N/μm			kg	FAG	
7000	11000	208	723	1523	640	2413	5455	93,6	163,8	239,5	—	0,8	B71826-C-TPA-P4
6300	9500	277	1092	2378	805	3288	7397	211,6	354,6	487,6	—	0,8	B71826-E-TPA-P4
9000	15000	119	452	975	360	1456	3330	84,2	146,5	210,2	—	0,8	HCB71826-C-TPA-P4
7500	12000	137	653	1493	399	1952	4574	187,2	328,8	452,6	—	0,8	HCB71826-E-TPA-P4
6700	10000	489	1600	3291	1508	5317	11665	117,5	199,0	285,6	•	1,5	B71926-C-T-P4S
6000	9000	714	2477	5193	2087	7472	16123	275,6	439,7	593,2	•	1,5	B71926-E-T-P4S
8500	14000	258	887	1858	781	2837	6249	102,6	169,8	237,6	•	1,3	HCB71926-C-T-P4S
7000	11000	349	1354	2923	1022	4049	8917	242,7	395,0	529,1	•	1,3	HCB71926-E-T-P4S
11000	18000	258	887	1858	781	2837	6249	102,6	169,8	237,6	•	1,3	XCB71926-C-T-P4S
9500	16000	349	1354	2923	1022	4049	8917	242,7	395,0	529,1	•	1,3	XCB71926-E-T-P4S
8500	14000	145	436	871	427	1345	2804	82,1	128,1	174,1	•	1,8	HS71926-C-T-P4S
7000	11000	238	713	1426	680	2074	4214	208,3	308,9	400,9	•	1,8	HS71926-E-T-P4S
9500	16000	100	300	600	295	914	1889	80,9	123,3	164,6	•	1,7	HC71926-C-T-P4S
8500	13000	163	488	975	470	1423	2879	207,5	305,2	392,7	•	1,7	HC71926-E-T-P4S
12000	19000	100	300	600	295	914	1889	80,9	123,3	164,6	•	1,7	XC71926-C-T-P4S
11000	18000	163	488	975	470	1423	2879	207,5	305,2	392,7	•	1,7	XC71926-E-T-P4S
6000	9000	857	2720	5545	2658	9109	19842	137,9	231,8	332,6	•	3,2	B7026-C-T-P4S
5600	8500	1322	4358	8972	3877	13200	27997	327,9	515,3	692,2	•	3,2	B7026-E-T-P4S
7500	12000	460	1518	3139	1402	4882	10629	120,9	197,6	275,9	•	2,7	HCB7026-C-T-P4S
6700	10000	673	2379	5019	1976	7133	15398	292,4	461,5	614,7	•	2,7	HCB7026-E-T-P4S
10000	17000	460	1518	3139	1402	4882	10629	120,9	197,6	275,9	•	2,7	XCB7026-C-T-P4S
8500	14000	673	2379	5019	1976	7133	15398	292,4	461,5	614,7	•	2,7	XCB7026-E-T-P4S
7500	12000	228	683	1367	675	2113	4422	92,9	144,9	197,6	•	3,7	HS7026-C-T-P4S
6700	10000	368	1104	2208	1053	3212	6547	233,4	346,6	450,6	•	3,7	HS7026-E-T-P4S
9000	15000	159	476	951	470	1455	3007	91,8	140,1	187,3	•	3,5	HC7026-C-T-P4S
8000	12000	257	771	1541	741	2254	4567	234,1	345,0	444,5	•	3,5	HC7026-E-T-P4S
12000	19000	159	476	951	470	1455	3007	91,8	140,1	187,3	•	3,5	XC7026-C-T-P4S
10000	17000	257	771	1541	741	2254	4567	234,1	345,0	444,5	•	3,5	XC7026-E-T-P4S
5600	8500	1316	4108	8347	4084	13741	29821	147,9	246,8	353,2	—	6,3	B7226-C-T-P4S
5000	7500	2079	6671	13628	6116	20247	42633	355,2	552,6	740,1	—	6,3	B7226-E-T-P4S
7000	11000	719	2304	4709	2193	7407	15918	130,6	210,9	292,8	—	5,2	HCB7226-C-T-P4S
6000	9000	1079	3624	7521	3177	10892	23040	318,7	494,0	652,9	—	5,2	HCB7226-E-T-P4S

FAG Spindle Bearings

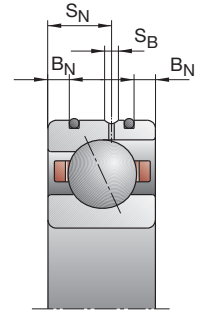
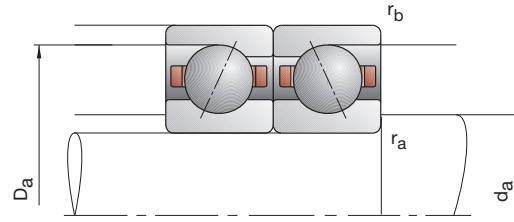
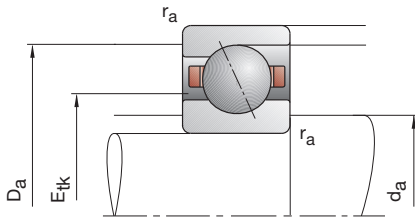

Bearing code	Dimensions					Abutment dimensions				DLR dimensions			Load rating			
	d	D	B	r _{smin}	r _{1smin}	d _a	D _a	r _a	r _b	B _N	S _N	S _B	E _{tk} nom.	C _{dyn}	C _{0stat}	
FAG	mm														kN	
B71828-C-TPA-P4	140	175	18	1,10	0,60	147	168	1,1	0,6				153,1	43,00	54,00	
B71828-E-TPA-P4	140	175	18	1,10	0,60	147	168	1,1	0,6				153,1	40,50	51,00	
HCB71828-C-TPA-P4	140	175	18	1,10	0,60	147	168	1,1	0,6				153,1	30,00	38,00	
HCB71828-E-TPA-P4	140	175	18	1,10	0,60	147	168	1,1	0,6				153,1	28,00	35,50	
B71928-C-T-P4S	140	190	24	1,50	1,50	149	181	0,6	0,6				160,2	90,00	108,00	
B71928-E-T-P4S	140	190	24	1,50	1,50	149	181	0,6	0,6				160,2	85,00	102,00	
HCB71928-C-T-P4S	140	190	24	1,50	1,50	149	181	0,6	0,6				160,2	62,00	76,50	
HCB71928-E-T-P4S	140	190	24	1,50	1,50	149	181	0,6	0,6				160,2	58,50	71,00	
XCB71928-C-T-P4S	140	190	24	1,50	1,50	149	181	0,6	0,6				160,2	137,00	76,50	
XCB71928-E-T-P4S	140	190	24	1,50	1,50	149	181	0,6	0,6				160,2	129,00	71,00	
B7028-C-T-P4S	140	210	33	2,00	2,00	152	199	2,0	1,0				167,2	146,00	160,00	
B7028-E-T-P4S	140	210	33	2,00	2,00	152	199	2,0	1,0				167,2	140,00	150,00	
HCB7028-C-T-P4S	140	210	33	2,00	2,00	152	199	2,0	1,0				167,2	102,00	110,00	
HCB7028-E-T-P4S	140	210	33	2,00	2,00	152	199	2,0	1,0				167,2	96,50	104,00	
XCB7028-C-T-P4S	140	210	33	2,00	2,00	152	199	2,0	1,0				167,2	228,00	110,00	
XCB7028-E-T-P4S	140	210	33	2,00	2,00	152	199	2,0	1,0				167,2	216,00	104,00	
B7228-C-T-P4S	140	250	42	3,00	3,00	163	226,5	2,5	2,5				185,5	220,00	232,00	
B7228-E-T-P4S	140	250	42	3,00	3,00	163	226,5	2,5	2,5				185,5	212,00	224,00	
HCB7228-C-T-P4S	140	250	42	3,00	3,00	163	226,5	2,5	2,5				185,5	153,00	163,00	
HCB7228-E-T-P4S	140	250	42	3,00	3,00	163	226,5	2,5	2,5				185,5	146,00	156,00	

- * options; • = possible, – = not possible
- ** see section Engineering, Speeds
- *** see section Engineering, Deflection and Rigidity

Designation examples:	Sealed design B7028-C-2RSD-T-P4S-UL	Hybrid ceramic design HCB71928-C-T-P4S-UL	X-life ultra design XCB7028-E-2RSD-T-P4S-UL XC7028-E-T-P4S-UL
------------------------------	---	---	--

B718..C/E, B719, B70, B72 HS719..C/E, HS70

C: Contact angle $\alpha = 15^\circ$
E: Contact angle $\alpha = 25^\circ$

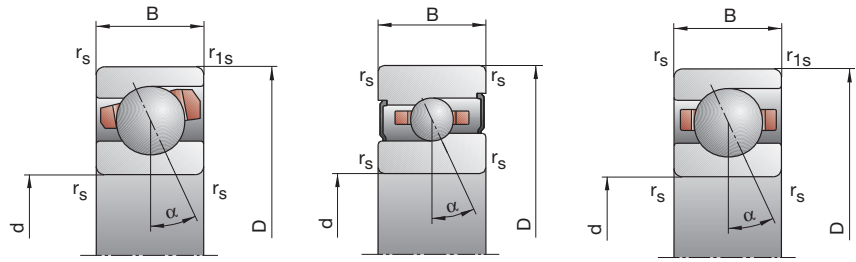

Attainable speed**		Preloading force			Unloading force***			Axial rigidity***			Sealed design*	Weight	Bearing code
Grease	Oil	L	M	H	L	M	H	L	M	H			
min ⁻¹	minimal	N			N/μm						kg	FAG	
6300	9500	208	728	1536	638	2418	5469	97,1	169,7	247,6	—	0,8	B71828-C-TPA-P4
6000	9000	275	1097	2397	798	3296	7435	219,6	369,0	507,2	—	0,8	B71828-E-TPA-P4
8000	13000	121	466	1007	366	1498	3430	88,1	153,7	220,4	—	0,8	HCB71828-C-TPA-P4
7000	11000	135	659	1511	393	1968	4620	194,0	343,2	472,1	—	0,8	HCB71828-E-TPA-P4
6000	9000	506	1661	3412	1557	5502	12044	124,7	210,9	301,9	•	1,6	B71928-C-T-P4S
5600	8500	740	2576	5405	2162	7760	16750	293,3	467,9	630,8	•	1,6	B71928-E-T-P4S
7500	12000	266	919	1928	804	2932	6464	108,9	180,1	251,8	•	1,4	HCB71928-C-T-P4S
6700	10000	354	1387	3002	1036	4142	9141	256,5	418,2	560,2	•	1,4	HCB71928-E-T-P4S
10000	17000	266	919	1928	804	2932	6464	108,9	180,1	251,8	•	1,4	XCB71928-C-T-P4S
8500	14000	354	1387	3002	1036	4142	9141	256,5	418,2	560,2	•	1,4	XCB71928-E-T-P4S
5600	8500	873	2775	5657	2703	9270	20180	142,9	240,1	343,9	•	3,4	B7028-C-T-P4S
5000	7500	1345	4446	9159	3941	13450	28537	340,3	534,9	718,2	•	3,4	B7028-E-T-P4S
7000	11000	480	1583	3273	1463	5089	11075	126,7	206,9	288,7	•	2,8	HCB7028-C-T-P4S
6300	9500	687	2434	5127	2016	7292	15712	304,0	479,8	638,4	•	2,8	HCB7028-E-T-P4S
9500	16000	480	1583	3273	1463	5089	11075	126,7	206,9	288,7	•	2,8	XCB7028-C-T-P4S
8000	13000	687	2434	5127	2016	7292	15712	304,0	479,8	638,4	•	2,8	XCB7028-E-T-P4S
5000	7500	1363	4259	8634	4222	14208	30737	155,8	259,6	370,7	—	8,1	B7228-C-T-P4S
4500	6700	2154	6923	14150	6331	20931	44194	374,8	582,4	780,4	—	8,1	B7228-E-T-P4S
6300	9500	747	2397	4901	2276	7692	16528	137,9	222,5	308,6	—	6,8	HCB7228-C-T-P4S
5300	8000	1133	3811	7910	3335	11447	24211	338,1	524,1	692,5	—	6,8	HCB7228-E-T-P4S

FAG Spindle Bearings

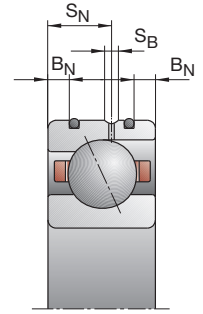
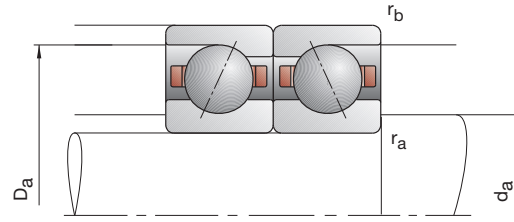
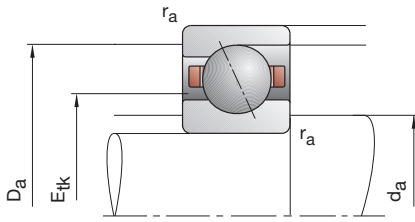

Bearing code	Dimensions					Abutment dimensions				DLR dimensions			Load rating		
	d	D	B	r _{smin}	r _{1smin}	d _a	D _a	r _a	r _b	B _N	S _N	S _B	E _{tk} nom.	C _{dyn}	C _{0stat}
FAG	mm														
B71830-C-TPA-P4	150	190	20	1,10	0,60	158	182	1,1	0,6				164,8	56,00	69,50
B71830-E-TPA-P4	150	190	20	1,10	0,60	158	182	1,1	0,6				164,8	52,00	64,00
HCB71830-C-TPA-P4	150	190	20	1,10	0,60	158	182	1,1	0,6				164,8	38,00	48,00
HCB71830-E-TPA-P4	150	190	20	1,10	0,60	158	182	1,1	0,6				164,8	36,00	45,00
B71930-C-T-P4S	150	210	28	2,00	1,00	160	199	1,0	1,0				174,3	122,00	143,00
B71930-E-T-P4S	150	210	28	2,00	1,00	160	199	1,0	1,0				174,3	114,00	134,00
HCB71930-C-T-P4S	150	210	28	2,00	1,00	160	199	1,0	1,0				174,3	85,00	100,00
HCB71930-E-T-P4S	150	210	28	2,00	1,00	160	199	1,0	1,0				174,3	80,00	95,00
XCB71930-C-T-P4S	150	210	28	2,00	1,00	160	199	1,0	1,0				174,3	190,00	100,00
XCB71930-E-T-P4S	150	210	28	2,00	1,00	160	199	1,0	1,0				174,3	180,00	95,00
B7030-C-T-P4S	150	225	35	2,10	2,10	163	213	2,1	1,0				178,5	183,00	193,00
B7030-E-T-P4S	150	225	35	2,10	2,10	163	213	2,1	1,0				178,5	173,00	186,00
HCB7030-C-T-P4S	150	225	35	2,10	2,10	163	213	2,1	1,0				178,5	127,00	137,00
HCB7030-E-T-P4S	150	225	35	2,10	2,10	163	213	2,1	1,0				178,5	120,00	129,00
XCB7030-C-T-P4S	150	225	35	2,10	2,10	163	213	2,1	1,0				178,5	285,00	137,00
XCB7030-E-T-P4S	150	225	35	2,10	2,10	163	213	2,1	1,0				178,5	270,00	129,00
B7230-C-T-P4S	150	270	45	3,00	3,00	178	241,5	2,5	2,5				200,5	228,00	255,00
B7230-E-T-P4S	150	270	45	3,00	3,00	178	241,5	2,5	2,5				200,5	216,00	240,00
HCB7230-C-T-P4S	150	270	45	3,00	3,00	178	241,5	2,5	2,5				200,5	156,00	176,00
HCB7230-E-T-P4S	150	270	45	3,00	3,00	178	241,5	2,5	2,5				200,5	150,00	166,00

- * options; • = possible, – = not possible
- ** see section Engineering, Speeds
- *** see section Engineering, Deflection and Rigidity

Designation examples:

Hybrid ceramic design
HCB71930-C-T-P4S-UL

X-life ultra design
XCB7030-E-T-P4S-UL

TX design
HCB7030-C-TX-P4S-UL

B718..C/E, B719, B70, B72 HS719..C/E, HS70

C: Contact angle $\alpha = 15^\circ$
E: Contact angle $\alpha = 25^\circ$

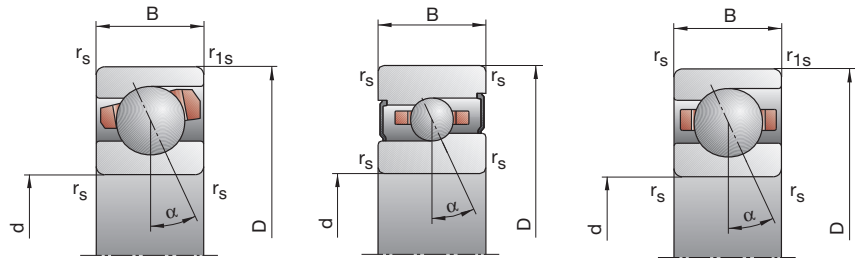

Attainable speed**		Preloading force F_V			Unloading force*** K_{aE}			Axial rigidity*** c_a			Sealed design*	Weight	Bearing code
Grease	Oil	L	M	H	L	M	H	L	M	H		kg	FAG
min ⁻¹	minimal	N						N/μm					
6000	9000	281	955	1995	866	3180	7140	108,7	188,1	274,0	—	1,1	B71830-C-TPA-P4
5300	8000	386	1465	3145	1124	4405	9789	248,3	410,2	561,3	—	1,1	B71830-E-TPA-P4
7500	12000	170	624	1332	516	2015	4559	100,1	172,0	245,8	—	1,1	HCB71830-C-TPA-P4
6300	9500	202	891	1994	588	2660	6112	224,3	383,5	523,9	—	1,1	HCB71830-E-TPA-P4
5600	8500	710	2286	4680	2188	7583	16579	141,4	237,8	340,6	—	2,5	B71930-C-T-P4S
5000	7500	1046	3541	7369	3055	10662	22894	332,6	525,8	707,9	—	2,5	B71930-E-T-P4S
7000	11000	375	1261	2622	1137	4024	8792	123,6	202,5	282,3	—	2,1	HCB71930-C-T-P4S
6000	9000	519	1925	4116	1523	5747	12558	294,8	471,4	629,5	—	2,1	HCB71930-E-T-P4S
9000	15000	375	1261	2622	1137	4024	8792	123,6	202,5	282,3	—	2,1	XCB71930-C-T-P4S
8000	13000	519	1925	4116	1523	5747	12558	294,8	471,4	629,5	—	2,1	XCB71930-E-T-P4S
5300	8000	1111	3503	7142	3449	11700	25557	157,2	263,0	377,6	—	4,1	B7030-C-T-P4S
4800	7000	1705	5555	11417	5003	16818	35626	373,2	583,4	782,8	—	4,1	B7030-E-T-P4S
6700	10000	601	1960	4031	1829	6289	13611	138,1	224,5	312,6	—	3,3	HCB7030-C-T-P4S
5600	8500	898	3106	6501	2639	9320	19942	336,8	527,5	700,2	—	3,3	HCB7030-E-T-P4S
8500	14000	601	1960	4031	1829	6289	13611	138,1	224,5	312,6	—	3,3	XCB7030-C-T-P4S
7500	12000	898	3106	6501	2639	9320	19942	336,8	527,5	700,2	—	3,3	XCB7030-E-T-P4S
4500	6700	1411	4410	8942	4364	14677	31741	163,8	272,4	388,5	—	10,3	B7230-C-T-P4S
4000	6000	2186	7023	14400	6418	21195	44874	391,6	607,6	814,2	—	10,3	B7230-E-T-P4S
5600	8500	768	2470	5053	2336	7909	16996	144,6	233,3	323,2	—	9,0	HCB7230-C-T-P4S
5000	7500	1144	3861	8025	3364	11580	24520	352,8	547,0	722,5	—	9,0	HCB7230-E-T-P4S

FAG Spindle Bearings

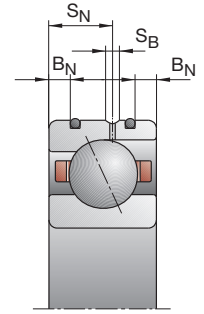
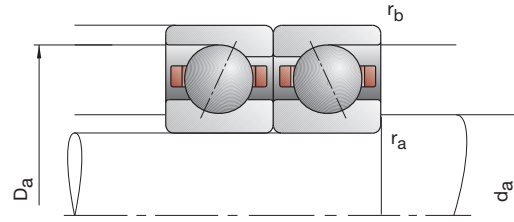
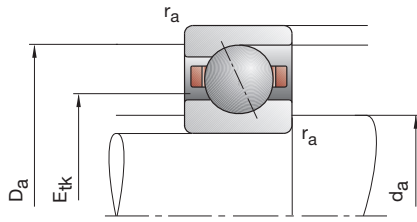

Bearing code	Dimensions					Abutment dimensions				DLR dimensions			Load rating		
	d	D	B	r _{smin}	r _{1smin}	d _a	D _a	r _a	r _b	B _N	S _N	S _B	E _{tk} nom.	C _{dyn}	C _{0stat}
FAG	mm														
B71832-C-TPA-P4	160	200	20	1,10	0,60	168	192	1,1	0,6				174,8	57,00	73,50
B71832-E-TPA-P4	160	200	20	1,10	0,60	168	192	1,1	0,6				174,8	54,00	68,00
HCB71832-C-TPA-P4	160	200	20	1,10	0,60	168	192	1,1	0,6				174,8	39,00	51,00
HCB71832-E-TPA-P4	160	200	20	1,10	0,60	168	192	1,1	0,6				174,8	37,50	48,00
B71932-C-T-P4S	160	220	28	2,00	1,00	170	209	1,0	1,0				184,3	125,00	150,00
B71932-E-T-P4S	160	220	28	2,00	1,00	170	209	1,0	1,0				184,3	116,00	140,00
HCB71932-C-T-P4S	160	220	28	2,00	1,00	170	209	1,0	1,0				184,3	85,00	104,00
HCB71932-E-T-P4S	160	220	28	2,00	1,00	170	209	1,0	1,0				184,3	80,00	98,00
XCB71932-C-T-P4S	160	220	28	2,00	1,00	170	209	1,0	1,0				184,3	190,00	104,00
XCB71932-E-T-P4S	160	220	28	2,00	1,00	170	209	1,0	1,0				184,3	180,00	98,00
B7032-C-T-P4S	160	240	38	2,10	2,10	174	228	2,0	1,0				191,0	190,00	208,00
B7032-E-T-P4S	160	240	38	2,10	2,10	174	228	2,0	1,0				191,0	176,00	196,00
HCB7032-C-T-P4S	160	240	38	2,10	2,10	174	228	2,0	1,0				191,0	129,00	143,00
HCB7032-E-T-P4S	160	240	38	2,10	2,10	174	228	2,0	1,0				191,0	122,00	137,00
XCB7032-C-T-P4S	160	240	38	2,10	2,10	174	228	2,0	1,0				191,0	290,00	143,00
XCB7032-E-T-P4S	160	240	38	2,10	2,10	174	228	2,0	1,0				191,0	270,00	137,00
B7232-C-T-P4S	160	290	48	3,00	3,00	191	259	2,5	2,5				215,5	245,00	285,00
B7232-E-T-P4S	160	290	48	3,00	3,00	191	259	2,5	2,5				215,5	232,00	270,00
HCB7232-C-T-P4S	160	290	48	3,00	3,00	191	259	2,5	2,5				215,5	170,00	200,00
HCB7232-E-T-P4S	160	290	48	3,00	3,00	191	259	2,5	2,5				215,5	160,00	190,00
B71834-C-TPA-P4	170	215	22	1,10	0,60	179	206	1,1	0,6				186,7	68,00	88,00
B71834-E-TPA-P4	170	215	22	1,10	0,60	179	206	1,1	0,6				186,7	64,00	81,50
HCB71834-C-TPA-P4	170	215	22	1,10	0,60	179	206	1,1	0,6				186,7	47,50	61,00
HCB71834-E-TPA-P4	170	215	22	1,10	0,60	179	206	1,1	0,6				186,7	45,00	57,00
B71934-C-T-P4S	170	230	28	2,00	1,50	180	219	1,0	1,0				194,3	129,00	163,00
B71934-E-T-P4S	170	230	28	2,00	1,50	180	219	1,0	1,0				194,3	122,00	150,00
HCB71934-C-T-P4S	170	230	28	2,00	1,50	180	219	1,0	1,0				194,3	88,00	114,00
HCB71934-E-T-P4S	170	230	28	2,00	1,50	180	219	1,0	1,0				194,3	83,00	106,00
B7034-C-T-P4S	170	260	42	2,10	2,10	185	246	2,0	1,0				203,8	236,00	270,00
B7034-E-T-P4S	170	260	42	2,10	2,10	185	246	2,0	1,0				203,8	224,00	255,00
B7234-C-T-P4S	170	310	52	4,00	4,00	205	275	3,0	3,0				228,6	300,00	360,00
B7234-E-T-P4S	170	310	52	4,00	4,00	205	275	3,0	3,0				228,6	280,00	345,00

- * options; • = possible, – = not possible
- ** see section Engineering, Speeds
- *** see section Engineering, Deflection and Rigidity

Designation examples: **Sealed design** **Hybrid ceramic design** **X-life ultra design**
 B7032-C-2RSD-T-P4S-UL HCB71932-C-T-P4S-UL XCB7032-E-2RSD-T-P4S-UL

B718..C/E, B719, B70, B72 HS719..C/E, HS70

C: Contact angle $\alpha = 15^\circ$
E: Contact angle $\alpha = 25^\circ$

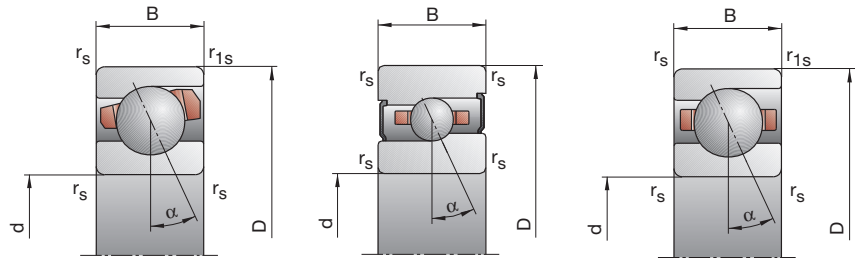

Attainable speed**		Preloading force F_V			Unloading force*** K_{aE}			Axial rigidity*** c_a			Sealed design*	Weight	Bearing code
Grease	Oil	L	M	H	L	M	H	L	M	H		kg	FAG
min ⁻¹	minimal	N						N/μm					
5 600	8 500	283	969	2 032	869	3 214	7 238	113,0	195,6	284,9	—	1,2	B71832-C-TPA-P4
5 000	7 500	389	1 485	3 194	1 132	4 457	9 917	259,3	428,3	585,7	—	1,2	B71832-E-TPA-P4
7 000	11 000	171	629	1 349	518	2 024	4 596	104,2	178,7	255,3	—	1,2	HCB71832-C-TPA-P4
6 000	9 000	203	911	2 043	591	2 717	6 253	234,1	402,1	549,2	—	1,2	HCB71832-E-TPA-P4
5 000	7 500	727	2 341	4 793	2 238	7 755	16 952	146,1	245,5	351,4	•	2,7	B71932-C-T-P4S
4 800	7 000	1 061	3 597	7 491	3 097	10 821	23 248	342,8	541,8	729,2	•	2,7	B71932-E-T-P4S
6 700	10 000	382	1 286	2 676	1 157	4 099	8 959	127,5	208,8	290,9	•	2,2	HCB71932-C-T-P4S
5 600	8 500	529	1 965	4 204	1 552	5 864	12 818	304,5	487,0	650,1	•	2,2	HCB71932-E-T-P4S
8 500	14 000	382	1 286	2 676	1 157	4 099	8 959	127,5	208,8	290,9	•	2,2	XCB71932-C-T-P4S
7 500	12 000	529	1 965	4 204	1 552	5 864	12 818	304,5	487,0	650,1	•	2,2	XCB71932-E-T-P4S
4 800	7 000	1 152	3 635	7 412	3 573	12 127	26 413	164,1	274,5	393,4	—	5,1	B7032-C-T-P4S
4 300	6 300	1 728	5 642	11 602	5 066	17 061	36 142	386,8	604,6	810,7	—	5,1	B7032-E-T-P4S
6 000	9 000	624	2 034	4 184	1 898	6 521	14 111	144,4	234,6	326,4	—	4,3	HCB7032-C-T-P4S
5 300	8 000	911	3 160	6 621	2 676	9 473	20 288	349,4	547,3	726,5	—	4,3	HCB7032-E-T-P4S
8 000	13 000	624	2 034	4 184	1 898	6 521	14 111	144,4	234,6	326,4	—	4,3	XCB7032-C-T-P4S
6 700	10 000	911	3 160	6 621	2 676	9 473	20 288	349,4	547,3	726,5	—	4,3	XCB7032-E-T-P4S
4 300	6 300	1 513	4 734	9 601	4 669	15 702	33 935	179,9	298,6	425,1	—	13,0	B7232-C-T-P4S
3 800	5 600	2 339	7 529	15 450	6 844	22 687	48 049	430,4	668,0	894,5	—	13,0	B7232-E-T-P4S
5 300	8 000	832	2 676	5 478	2 528	8 552	18 377	159,6	257,2	356,0	—	11,6	HCB7232-C-T-P4S
4 500	6 700	1 231	4 167	8 669	3 618	12 488	26 454	389,0	603,5	796,8	—	11,6	HCB7232-E-T-P4S
5 000	7 500	357	1 199	2 492	1 097	3 988	8 875	122,5	210,9	305,7	—	1,6	B71834-C-TPA-P4
4 500	6 700	499	1 842	3 924	1 451	5 538	12 172	282,1	461,1	627,9	—	1,6	B71834-E-TPA-P4
6 300	9 500	216	772	1 638	654	2 485	5 597	112,6	191,4	272,7	—	1,6	HCB71834-C-TPA-P4
5 600	8 500	274	1 148	2 539	799	3 431	7 770	258,7	434,4	590,4	—	1,6	HCB71834-E-TPA-P4
4 800	7 000	747	2 410	4 941	2 295	7 954	17 399	154,3	258,7	369,9	—	2,8	B71934-C-T-P4S
4 500	6 700	1 111	3 777	7 870	3 242	11 353	24 396	365,5	577,8	777,2	—	2,8	B71934-E-T-P4S
6 000	9 000	392	1 328	2 765	1 186	4 222	9 226	134,9	220,8	307,2	—	2,4	HCB71934-C-T-P4S
5 300	8 000	542	2 028	4 349	1 589	6 046	13 242	322,2	516,2	689,2	—	2,4	HCB71934-E-T-P4S
4 500	6 700	1 458	4 562	9 252	4 504	15 154	32 763	171,7	285,2	406,4	—	6,7	B7034-C-T-P4S
4 000	6 000	2 263	7 276	14 926	6 641	21 942	46 466	411,2	637,9	854,5	—	6,7	B7034-E-T-P4S
4 000	6 000	1 878	5 842	11 825	5 792	19 336	41 658	190,3	314,3	446,1	—	16,0	B7234-C-T-P4S
3 600	5 300	2 879	9 183	18 737	8 424	27 661	58 033	454,6	702,4	936,0	—	16,0	B7234-E-T-P4S

B718..C/E, B719, B70, B72 HS719..C/E, HS70

C: Contact angle $\alpha = 15^\circ$
E: Contact angle $\alpha = 25^\circ$

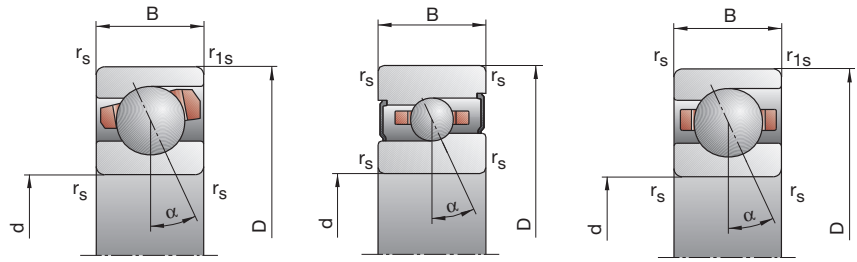

Attainable speed**		Preloading force			Unloading force***			Axial rigidity***			Sealed design*	Weight	Bearing code
Grease	Oil	L	M	H	L	M	H	L	M	H			
min ⁻¹	minimal	N						N/μm			kg	FAG	
4800	7000	372	1250	2600	1142	4151	9241	129,2	222,3	322,0	—	1,7	B71836-C-TPA-P4
4300	6300	520	1919	4103	1511	5766	12717	297,8	486,8	663,3	—	1,7	B71836-E-TPA-P4
6000	9000	219	786	1669	662	2530	5681	117,6	200,0	284,1	—	1,7	HCB71836-C-TPA-P4
5300	8000	274	1166	2586	799	3481	7901	269,6	454,4	617,5	—	1,7	HCB71836-E-TPA-P4
4500	6700	966	3086	6300	2974	10221	22230	168,9	282,3	402,7	—	4,2	B71936-C-T-P4S
4000	6000	1478	4921	10164	4320	14823	31493	403,5	633,6	849,1	—	4,2	B71936-E-T-P4S
5600	8500	516	1708	3546	1565	5442	11841	148,5	241,1	335,1	—	3,5	HCB71936-C-T-P4S
4800	7000	734	2644	5595	2150	7894	17065	357,4	565,8	752,2	—	3,5	HCB71936-E-T-P4S
4000	6000	1513	4733	9600	4669	15697	33928	179,9	298,6	425,1	—	8,9	B7036-C-T-P4S
3800	5600	2339	7529	15449	6843	22685	48042	430,4	668,0	894,5	—	8,9	B7036-E-T-P4S
3800	5600	1906	5935	12015	5866	19581	42153	198,0	326,4	462,3	—	16,8	B7236-C-T-P4S
3400	5000	2977	9503	19395	8706	28601	60002	477,2	737,1	981,7	—	16,8	B7236-E-T-P4S
4500	6700	353	1299	2772	1074	4276	9771	130,0	230,5	336,7	—	2,2	B71838-C-TPA-P4
4000	6000	429	1898	4254	1243	5671	13114	288,3	499,6	691,5	—	2,2	B71838-E-TPA-P4
5600	8500	190	797	1764	571	2544	5959	115,1	205,9	296,8	—	2,2	HCB71838-C-TPA-P4
4800	7000	181	1095	2626	526	3252	7985	242,2	458,8	640,0	—	2,2	HCB71838-E-TPA-P4
4300	6300	894	2996	6210	2736	9846	21803	167,2	283,7	407,1	—	4,4	B71938-C-T-P4S
3800	5600	1259	4576	9707	3666	13727	29966	390,1	630,2	851,6	—	4,4	B71938-E-T-P4S
5300	8000	449	1619	3440	1353	5130	11428	144,0	240,8	337,0	—	3,6	HCB71938-C-T-P4S
4500	6700	564	2402	5321	1650	7148	16175	334,3	559,2	754,7	—	3,6	HCB71938-E-T-P4S
3800	5600	1445	4671	9575	4437	15414	33658	181,9	304,8	435,1	—	9,3	B7038-C-T-P4S
3600	5300	2141	7290	15228	6260	21908	47088	430,9	680,6	915,2	—	9,3	B7038-E-T-P4S
3400	5000	1860	5955	12166	5701	19571	42506	202,3	336,4	477,6	—	20,3	B7238-C-T-P4S
3200	4800	2816	9424	19525	8217	28309	60271	484,1	759,4	1016,1	—	20,3	B7238-E-T-P4S

B718..C/E, B719, B70, B72 HS719..C/E, HS70

C: Contact angle $\alpha = 15^\circ$
E: Contact angle $\alpha = 25^\circ$

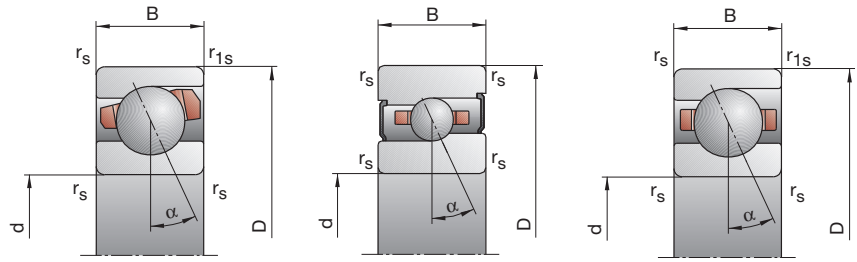

Attainable speed**		Preloading force			Unloading force***			Axial rigidity***			Sealed design*	Weight	Bearing code
Grease	Oil	L	M	H	L	M	H	L	M	H			
min ⁻¹	minimal	N						N/μm			kg	FAG	
4 300	6 300	355	1 317	2 817	1 080	4 320	9 888	134,9	239,0	348,9	—	2,3	B71840-C-TPA-P4
3 800	5 600	428	1 920	4 319	1 239	5 728	13 287	298,8	519,7	719,4	—	2,3	B71840-E-TPA-P4
5 300	8 000	191	806	1 789	573	2 565	6 022	119,5	213,7	307,8	—	2,3	HCB71840-C-TPA-P4
4 500	6 700	177	1 103	2 659	514	3 273	8 073	249,5	477,0	665,9	—	2,3	HCB71840-E-TPA-P4
4 000	6 000	1 133	3 734	7 704	3 479	12 312	27 075	180,4	304,6	436,2	—	6,1	B71940-C-T-P4S
3 600	5 300	1 643	5 803	12 213	4 794	17 453	37 826	424,3	679,6	916,6	—	6,1	B71940-E-T-P4S
5 000	7 500	578	2 027	4 272	1 747	6 443	14 237	156,1	258,7	361,2	—	5,1	HCB71940-C-T-P4S
4 300	6 300	761	3 056	6 660	2 225	9 111	20 237	367,3	603,1	808,9	—	5,1	HCB71940-E-T-P4S
3 600	5 300	1 805	5 771	11 787	5 539	19 000	41 275	193,5	322,1	457,8	—	12,0	B7040-C-T-P4S
3 200	4 800	2 730	9 122	18 891	7 970	27 422	58 373	462,5	725,5	971,1	—	12,0	B7040-E-T-P4S
3 200	4 800	1 916	6 138	12 545	5 866	20 139	43 737	211,0	350,6	497,4	—	24,4	B7240-C-T-P4S
3 000	4 500	2 901	9 725	20 159	8 461	29 193	62 166	505,7	793,3	1 061,0	—	24,4	B7240-E-T-P4S
3 800	5 600	358	1 335	2 861	1 087	4 366	10 004	139,8	247,6	361,0	—	2,5	B71844-C-TPA-P4
3 400	5 000	427	1 943	4 384	1 235	5 789	13 463	309,1	539,7	747,1	—	2,5	B71844-E-TPA-P4
4 800	7 000	191	815	1 815	572	2 587	6 089	123,5	221,4	318,8	—	2,5	HCB71844-C-TPA-P4
4 000	6 000	166	1 081	2 630	482	3 202	7 987	253,1	489,9	685,9	—	2,5	HCB71844-E-TPA-P4
3 600	5 300	1 191	3 942	8 140	3 646	12 940	28 444	196,9	331,8	474,0	—	6,7	B71944-C-T-P4S
3 200	4 800	1 714	6 084	12 867	4 995	18 257	39 642	463,3	741,8	999,9	—	6,7	B71944-E-T-P4S
4 500	6 700	618	2 176	4 593	1 861	6 882	15 259	171,7	284,2	396,9	—	5,6	HCB71944-C-T-P4S
3 800	5 600	799	3 255	7 114	2 334	9 694	21 583	402,2	663,1	889,5	—	5,6	HCB71944-E-T-P4S
3 200	4 800	1 916	6 138	12 545	5 866	20 139	43 737	211,0	350,6	497,4	—	16,0	B7044-C-T-P4S
3 000	4 500	2 901	9 725	20 159	8 461	29 193	62 166	505,7	793,3	1 061,0	—	16,0	B7044-E-T-P4S
2 800	4 300	2 406	7 621	15 567	7 360	24 861	54 043	225,4	371,1	525,7	—	33,6	B7244-C-T-P4S
2 600	4 000	3 670	12 081	24 979	10 706	36 160	76 950	542,6	843,8	1 127,0	—	33,6	B7244-E-T-P4S

FAG Spindle Bearings

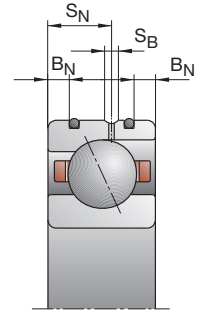
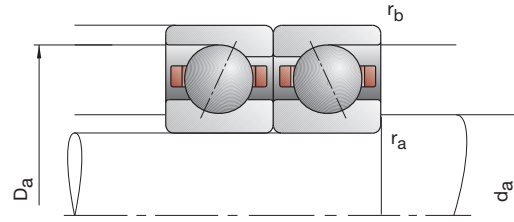
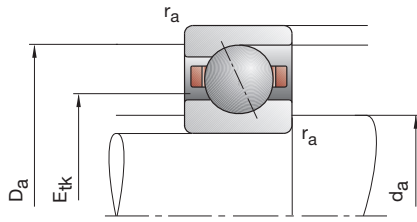

Bearing code	Dimensions					Abutment dimensions				DLR dimensions			Load rating		
	d	D	B	r _{smin}	r _{1smin}	d _a	D _a	r _a	r _b	B _N	S _N	S _B	E _{tk} nom.	C _{dyn}	C _{0stat}
FAG	mm													kN	
B71848-C-TPA-P4	240	300	28	2,00	1,00	253	287	2,0	1,0				262,8	106,00	150,00
B71848-E-TPA-P4	240	300	28	2,00	1,00	253	287	2,0	1,0				262,8	98,00	140,00
HCB71848-C-TPA-P4	240	300	28	2,00	1,00	253	287	2,0	1,0				262,8	72,00	104,00
HCB71848-E-TPA-P4	240	300	28	2,00	1,00	253	287	2,0	1,0				262,8	68,00	96,50
B71948-C-T-P4S	240	320	38	2,10	1,10	254	307	1,0	1,0	7,0	22,0	2,2	272,4	224,00	310,00
B71948-E-T-P4S	240	320	38	2,10	1,10	254	307	1,0	1,0	7,0	22,0	2,2	272,4	212,00	285,00
HCB71948-C-T-P4S	240	320	38	2,10	1,10	254	307	1,0	1,0	7,0	22,0	2,2	272,4	153,00	216,00
HCB71948-E-T-P4S	240	320	38	2,10	1,10	254	307	1,0	1,0	7,0	22,0	2,2	272,4	146,00	200,00
B7048-C-T-P4S	240	360	56	3,00	3,00	260	341	2,5	1,0				286,5	335,00	465,00
B7048-E-T-P4S	240	360	56	3,00	3,00	260	341	2,5	1,0				286,5	315,00	440,00
B71952-C-T-P4S	260	360	46	2,10	1,10	278	342	1,0	1,0	8,0	26,0	2,2	300,5	285,00	415,00
B71952-E-T-P4S	260	360	46	2,10	1,10	278	342	1,0	1,0	8,0	26,0	2,2	300,5	270,00	390,00
B71956-C-T-P4S	280	380	46	2,10	1,10	298	362	1,0	1,0				320,5	300,00	450,00
B71956-E-T-P4S	280	380	46	2,10	1,10	298	362	1,0	1,0				320,5	280,00	425,00
B71960-C-T-P4S	300	420	56	3,00	1,10	322	398	1,5	1,0				348,6	360,00	570,00
B71960-E-T-P4S	300	420	56	3,00	1,10	322	398	1,5	1,0				348,6	340,00	540,00
B71964-C-T-P4S	320	440	56	3,00	1,10	342	418	1,5	1,0				368,6	375,00	620,00
B71964-E-T-P4S	320	440	56	3,00	1,10	342	418	1,5	1,0				368,6	355,00	585,00
B71968-C-T-P4S	340	460	56	3,00	1,10	362	438	1,5	1,0				388,6	380,00	640,00
B71968-E-T-P4S	340	460	56	3,00	1,10	362	438	1,5	1,0				388,6	360,00	610,00
B71972-C-T-P4S	360	480	56	3,00	1,10	382	458	1,5	1,0				408,6	390,00	695,00
B71972-E-T-P4S	360	480	56	3,00	1,10	382	458	1,5	1,0				408,6	375,00	640,00
B71984-C-T-P4S	420	560	65	4,00	1,50	443	537	1,5	1,0				476,0	510,00	980,00
B71984-E-T-P4S	420	560	65	4,00	1,50	443	537	1,5	1,0				476,0	475,00	915,00

- * options; • = possible, – = not possible
- ** see section Engineering, Speeds
- *** see section Engineering, Deflection and Rigidity

Designation examples: **Hybrid ceramic design** **Direct Lube design**
 HCB71948-C-T-P4S-UL HCB7048-EDLR-T-P4S-UL

B718..C/E, B719, B70, B72 HS719..C/E, HS70

C: Contact angle $\alpha = 15^\circ$
E: Contact angle $\alpha = 25^\circ$

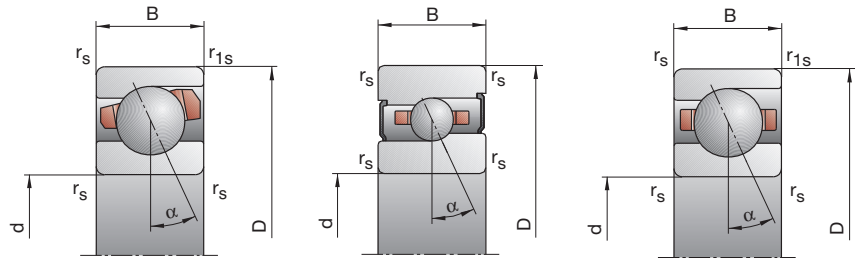

Attainable speed**		Preloading force			Unloading force***			Axial rigidity***			Sealed design*	Weight	Bearing code
Grease	Oil	L	M	H	L	M	H	L	M	H			
min ⁻¹	minimal	N			N			N/μm			kg	FAG	
3 400	5 000	493	1 763	3 743	1 501	5 795	13 170	156,0	272,7	397,0	—	3,9	B71848-C-TPA-P4
3 000	4 500	613	2 571	5 687	1 773	7 681	17 504	348,3	592,4	814,5	—	3,9	B71848-E-TPA-P4
4 300	6 300	271	1 084	2 370	813	3 448	7 964	139,0	243,9	349,0	—	3,9	HCB71848-C-TPA-P4
3 600	5 300	282	1 519	3 561	819	4 515	10 824	301,7	549,2	759,1	—	3,9	HCB71848-E-TPA-P4
3 200	4 800	1 230	4 079	8 431	3 759	13 355	29 363	207,8	349,8	499,1	—	7,2	B71948-C-T-P4S
3 000	4 500	1 768	6 303	13 347	5 149	18 893	41 059	489,6	784,5	1 057,1	—	7,2	B71948-E-T-P4S
4 000	6 000	632	2 237	4 729	1 900	7 059	15 665	180,7	299,2	417,4	—	6,0	HCB71948-C-T-P4S
3 600	5 300	794	3 280	7 196	2 318	9 755	21 789	419,8	694,6	932,0	—	6,0	HCB71948-E-T-P4S
3 000	4 500	1 971	6 321	12 923	6 028	20 706	44 965	219,7	364,8	517,2	—	17,0	B7048-C-T-P4S
2 800	4 300	2 933	9 860	20 455	8 547	29 565	62 978	523,7	821,7	1 098,4	—	17,0	B7048-E-T-P4S
3 000	4 500	1 625	5 291	10 870	4 955	17 278	37 700	222,8	371,5	527,4	—	12,1	B71952-C-T-P4S
2 600	4 000	2 393	8 255	17 265	6 977	24 698	53 045	530,5	838,7	1 124,2	—	12,1	B71952-E-T-P4S
2 600	4 000	1 706	5 562	11 434	5 196	18 131	39 565	237,5	395,6	561,2	—	12,9	B71956-C-T-P4S
2 400	3 800	2 463	8 534	17 870	7 176	25 504	54 810	562,2	889,2	1 191,1	—	12,9	B71956-E-T-P4S
2 400	3 800	2 097	6 764	13 849	6 380	21 926	47 710	249,9	412,9	583,7	—	20,4	B71960-C-T-P4S
2 200	3 600	3 116	10 570	21 984	9 061	31 517	67 389	598,5	938,7	1 254,1	—	20,4	B71960-E-T-P4S
2 200	3 600	2 177	7 017	14 413	6 612	22 683	49 487	265,7	437,8	618,7	—	21,6	B71964-C-T-P4S
2 000	3 400	3 235	11 010	22 920	9 401	32 795	70 159	637,3	999,9	1 335,1	—	21,6	B71964-E-T-P4S
2 200	3 600	2 061	6 876	14 282	6 235	22 142	48 709	265,6	442,4	626,4	—	22,7	B71968-C-T-P4S
1 900	3 200	2 930	10 616	22 515	8 516	31 562	68 780	630,3	1 008,6	1 354,6	—	22,7	B71968-E-T-P4S
2 000	3 400	2 101	7 037	14 635	6 343	22 593	49 716	279,0	464,3	656,5	—	23,9	B71972-C-T-P4S
1 800	3 000	3 030	11 025	23 411	8 803	32 751	71 437	666,9	1 068,0	1 434,0	—	23,9	B71972-E-T-P4S
1 700	2 800	2 839	9 357	19 309	8 565	29 947	65 251	320,4	528,2	741,9	—	37,6	B71984-C-T-P4S
1 500	2 400	4 017	14 226	29 996	11 640	42 213	91 049	761,4	1 206,4	1 610,3	—	37,6	B71984-E-T-P4S

B718..C/E, B719, B70, B72 HS719..C/E, HS70

C: Contact angle $\alpha = 15^\circ$
E: Contact angle $\alpha = 25^\circ$

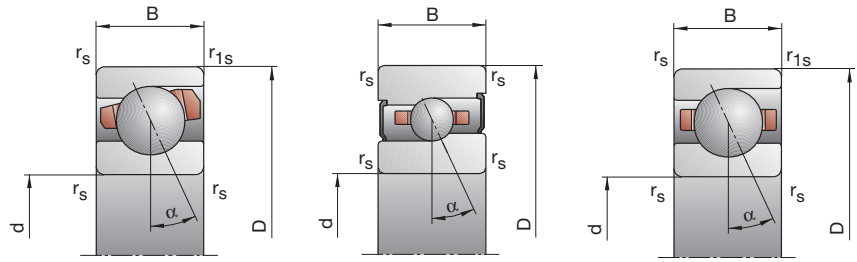

Attainable speed**	Grease	Oil	Preloading force			Unloading force***			Axial rigidity***			Sealed design*	Weight	Bearing code
			F _V	L	M	H	K _{aE}	L	M	H	c _a			
min ⁻¹		minimal	N						N/μm				kg	FAG
1500	2400	2927	9690	20023	8808	30891	67307	344,3	566,6	794,1	—	55,4	B71992-C-T-P4S	
1400	2200	4182	14905	31485	12108	44175	95395	823,0	1305,6	1741,8	—	55,4	B71992-E-T-P4S	
1400	2200	2827	9719	20317	8467	30828	67881	358,6	596,5	837,6	—	68,2	B719/500-C-T-P4S	
1200	1900	3842	14698	31683	11098	43473	95732	846,5	1373,9	1843,5	—	68,2	B719/500-E-T-P4S	

FAG Floating Displacement Bearings





The FAG Floating Displacement Bearing (FD) is the ideal floating bearing solution for when maximum speeds should be achieved and the requirements for carrying capacity are not decisive. FD Bearings reach the speeds of High Speed Angular Contact Thrust Ball Bearings. They run more than twice as quickly as Standard Cylindrical Roller Bearings. They therefore are used especially in motor spindles.

The design is basically a combination of a ball bearing outer ring and a Cylindrical Roller Bearing inner ring. Ceramic balls are used standard as rolling elements. This design ensures a free displacement of the outer ring relative to the inner ring during operation. The inner ring is made of Cronidur 30 high performance steel, which permits higher Hertzian contact pressures

in comparison with conventional rolling bearing steel. The contact between the inner ring and rolling elements ensures that the material pairing of Cronidur 30 and ceramic balls has adequate load carrying capacity. During fitting, the bearing clearance must be set according to the operating conditions. The application engineering department of the Schaeffler Group Industrial offers consultation in this regard by simulating the operating conditions. FAG FD bearings exhibit the same external dimensions as Spindle Bearings of the series B70.. or Cylindrical Roller Bearings of the series N10... Sufficient load carrying capacity coupled with very high speed-ability gives the designer entirely new possibilities for the floating bearing location. FD Bearings can also be integrated into

existing structures with low load rating requirements in order to easily increase the permissible speeds.

FAG offers both Floating Displacement Bearings and Spindle Bearings in an optional design sealed on both sides (2RSD) or in Direct Lube (DLR) design for oil-air lubrication. Analogous to FAG Super Precision Cylindrical Roller Bearings, FD Bearings are also available with a tapered inner ring bore (K). FD Bearings are also available with a radial clearance matched to the bearing bore (T64), which simplifies allocating bearings to the shaft and also permits multiple bearings to be mounted side by side in a set. (See the “Customized special solutions” chapter, pages 218 ff.)



1: Floating Displacement Bearing (FD..)



2: FD..DLR
Direct Lube design

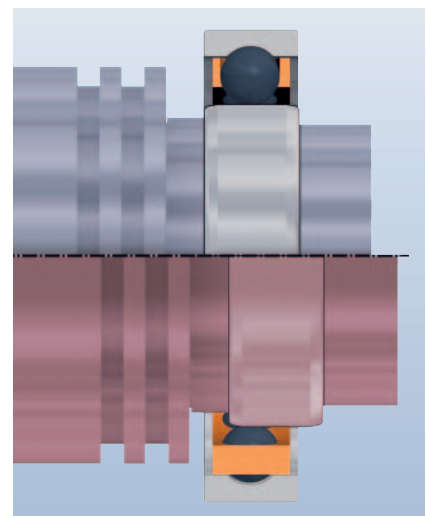

3: FD Bearings permit a sure and free displacement between inner and outer ring.

Bearing Code of FAG Floating Displacement Bearings

FD 10 10 -T-P4S
FD 10 10 -T-P4S-R10-15
FD 10 10-K -T-P4S
FD 10 10 -DLR-T-P4S
FD 10 10-2RSD-T-P4S

Bearing Type

FD Floating Displacement Bearing
Cronidur inner ring
Ceramic balls

Dimension Series

10 Medium series

Bore Reference Number

00 10 mm
01 12 mm
02 15 mm
03 17 mm
04 4 · 5 = 20 mm
05 5 · 5 = 25 mm

External Form

-DLR Direct Lube
Direct radial lubrication holes
with integral O rings

Individual Radial Clearance

freely selectable in µm steps
See bearing data for standard radial clearance.

Accuracy

P4S FAG standard
better than P4 according to
DIN 620

Cage

T Textile laminated phenolic resin
Outer ring guided

Tapered Bore

K tapered bore (taper 1:12)

Seal

-2RSD Sealed on both sides and
lubricated with L075
Sealed designs are indicated with
a point (•) in the bearing tables.

Bearing marking of FAG Floating Displacement Bearings

FD Bearings in unsealed design

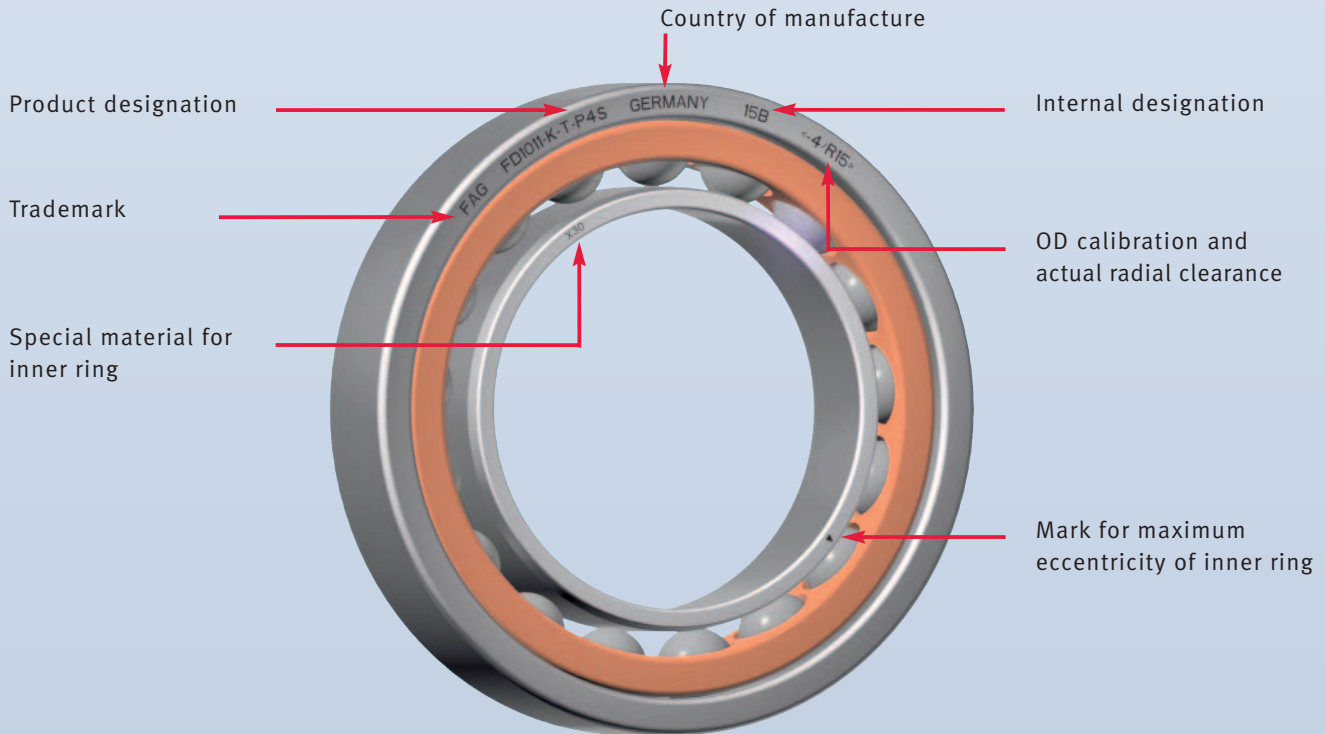

FD Bearings in sealed design

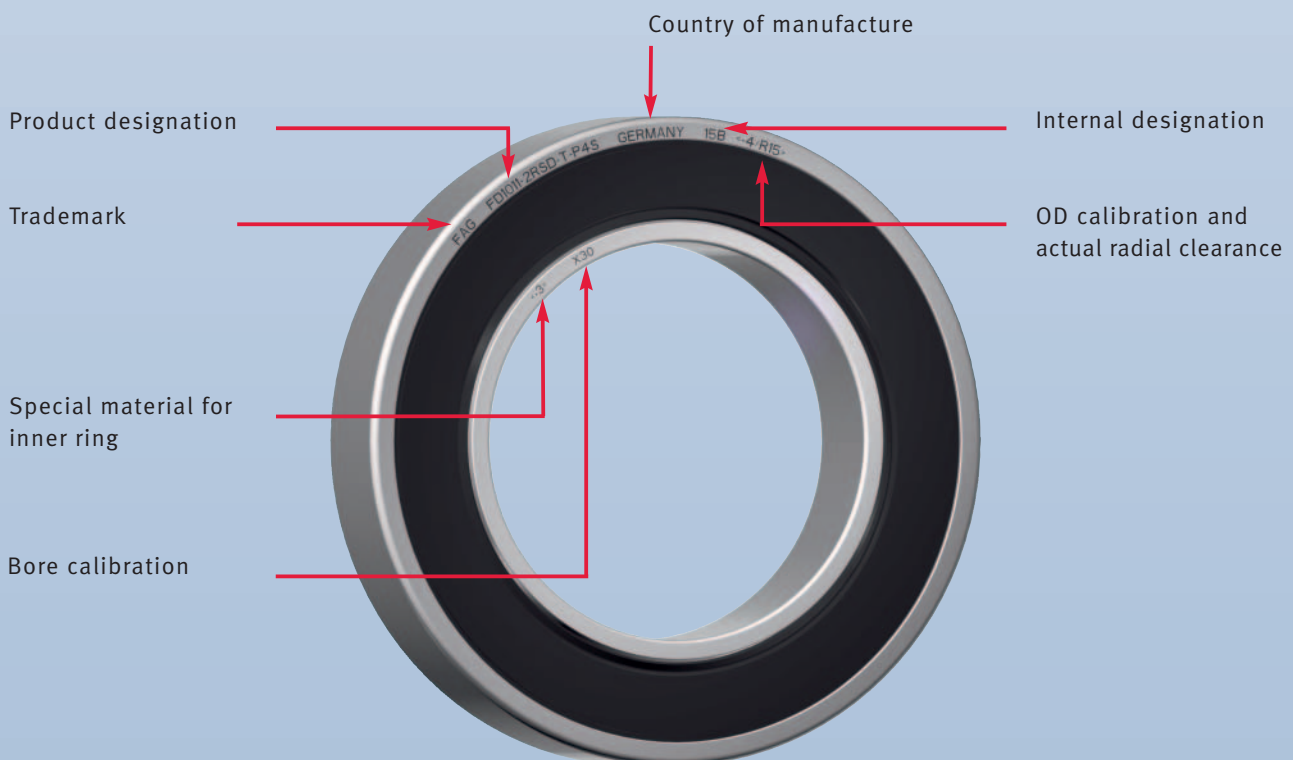

FAG Floating Displacement Bearings

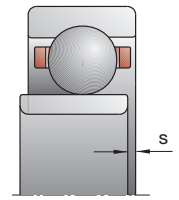
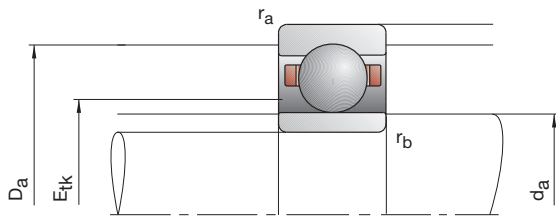

Bearing code	Dimensions						Abutment dimensions			
	d	D	B	r _{smin}	r _{1smin}	s	d _a h12	D _a H12	r _a max	r _b max
FAG	mm									
FD1000-T-P4S	10	26	8	0,30	0,30	1,2	13,5	22,0	0,3	0,3
FD1001-T-P4S	12	28	8	0,30	0,30	1,2	16,0	24,5	0,3	0,3
FD1002-T-P4S	15	32	9	0,30	0,30	1,7	18,0	29,0	0,3	0,3
FD1003-T-P4S	17	35	10	0,30	0,30	2,0	20,0	32,0	0,3	0,3
FD1004-T-P4S	20	42	12	0,60	0,30	2,3	24,0	37,0	0,6	0,3
FD1005-T-P4S	25	47	12	0,60	0,30	2,5	28,0	42,5	0,6	0,3
FD1006-T-P4S	30	55	13	1,00	0,60	2,6	35,0	50,0	1,0	0,6
FD1007-T-P4S	35	62	14	1,00	0,60	2,7	40,0	56,5	1,0	0,6
FD1008-T-P4S	40	68	15	1,00	0,60	2,7	45,0	62,0	1,0	0,6
FD1009-T-P4S	45	75	16	1,00	0,60	3,2	50,0	69,0	1,0	0,6
FD1010-T-P4S	50	80	16	1,00	0,60	3,2	55,0	74,5	1,0	0,6
FD1011-T-P4S	55	90	18	1,10	1,00	3,8	60,0	84,0	1,1	1,0
FD1012-T-P4S	60	95	18	1,10	1,00	3,8	65,0	89,0	1,1	1,0
FD1013-T-P4S	65	100	18	1,10	1,00	3,8	70,0	94,0	1,1	1,0
FD1014-T-P4S	70	110	20	1,10	1,00	4,3	76,0	103,0	1,1	1,0
FD1015-T-P4S	75	115	20	1,10	1,00	4,3	81,0	108,0	1,1	1,0
FD1016-T-P4S	80	125	22	1,10	1,00	4,8	87,0	117,0	1,1	1,0

* options; • = possible, – = not possible

See “Customized Solutions” for additional FD design variants.

Designation examples:

Design with tapered bore
FD1010-K-T-P4S

Sealed design
FD1010-2RSD-T-P4S

Direct Lube design
FD1010-DLR-T-P4S

FD10

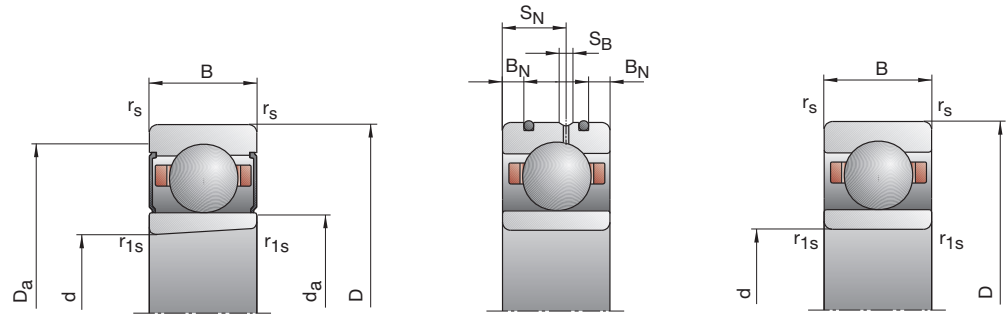

DLR dimensions

B_N S_N S_B E_{tk}
mm

Load rating

C_{dyn} C_{0stat}
kN

Attainable speed

Grease Oil minimal
 min^{-1}

Sealed design*

•

Weight

kg

Bearing code

FAG

			15,3	1,86	0,14	110 000	170 000	–	0,02	FD1000-T-P4S
			17,5	2,12	0,17	95 000	150 000	–	0,02	FD1001-T-P4S
			20,2	2,80	0,22	80 000	120 000	–	0,03	FD1002-T-P4S
			22,2	3,90	0,33	75 000	110 000	–	0,04	FD1003-T-P4S
			26,6	4,65	0,40	63 000	90 000	–	0,07	FD1004-T-P4S
			31,1	6,55	0,60	53 000	75 000	–	0,07	FD1005-T-P4S
2,5	7,6	1,4	38,0	6,80	0,67	43 000	63 000	•	0,11	FD1006-T-P4S
2,5	8,4	1,4	43,0	8,65	0,90	38 000	53 000	•	0,15	FD1007-T-P4S
3,0	8,9	1,4	48,5	9,50	1,02	36 000	50 000	•	0,18	FD1008-T-P4S
3,5	9,6	1,4	53,4	12,50	1,37	32 000	45 000	•	0,22	FD1009-T-P4S
3,5	9,6	1,4	58,4	12,90	1,50	30 000	43 000	•	0,24	FD1010-T-P4S
3,5	11,5	1,4	64,8	17,60	2,00	26 000	38 000	•	0,35	FD1011-T-P4S
3,5	11,5	1,4	69,8	18,00	2,16	26 000	38 000	•	0,38	FD1012-T-P4S
3,5	11,5	1,4	74,8	18,60	2,28	24 000	36 000	•	0,40	FD1013-T-P4S
4,0	12,8	1,4	81,2	22,40	2,80	22 000	34 000	•	0,55	FD1014-T-P4S
4,0	12,8	1,4	86,2	23,60	3,00	20 000	32 000	•	0,58	FD1015-T-P4S
4,5	14,2	1,4	92,6	29,00	3,75	18 000	28 000	•	0,78	FD1016-T-P4S



10
–
80

FD10

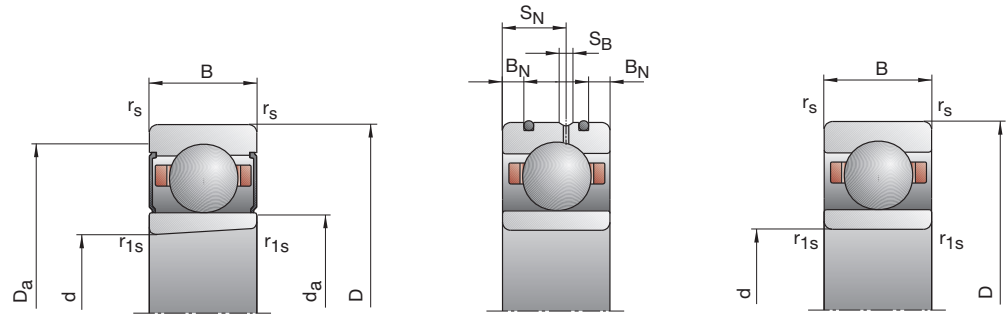

DLR dimensions

B_N S_N S_B E_{tk}
mm

Load rating

C_{dyn} C_{0stat}
kN

Attainable speed

Grease Oil
minimal
 min^{-1}

Sealed design*

Weight

kg

Bearing code

FAG

4,5	14,2	1,4	97,6	30,00	4,00	17 000	26 000	•	0,82	FD1017-T-P4S
5,0	15,6	2,2	104,0	35,50	4,65	16 000	24 000	•	1,07	FD1018-T-P4S
5,0	15,6	2,2	109,0	36,50	4,90	15 000	22 000	•	1,11	FD1019-T-P4S
5,0	15,6	2,2	114,0	38,00	5,20	15 000	22 000	•	1,16	FD1020-T-P4S
			119,4	49,00	6,70	14 000	20 000	–	1,42	FD1021-T-P4S
			126,9	51,00	7,10	13 000	19 000	–	1,83	FD1022-T-P4S
			136,9	52,00	7,50	12 000	18 000	–	1,95	FD1024-T-P4S
			149,7	67,00	9,65	11 000	17 000	–	2,96	FD1026-T-P4S
			159,7	69,50	10,20	10 000	15 000	–	3,13	FD1028-T-P4S
			170,0	85,00	12,50	9 000	14 000	–	3,69	FD1030-T-P4S
			182,5	86,50	13,40	9 000	13 000	–	4,70	FD1032-T-P4S



85
–
160

FAG Super Precision Cylindrical Roller Bearings



FAG Super Precision Cylindrical Roller Bearings are used where the highest accuracy is required. Machine tools and printing machines are typical applications for these bearings. They are ideal floating bearings as the linear expansion during rotation is accommodated between rollers and raceways. Due to their high accuracy and high radial rigidity, Cylindrical Roller Bearings are, aside from use as floating bearings, employed in high precision designs for the following bearing arrangements:

- Radially rigid
- High load carrying capacity
- High precision.

The standard series N10 (single row) and NN30 (double row) are an integral part of the FAG Super Precision range. The series N19 and NNU49 are also described in this catalog. These series have a smaller cross-section, which permits, for example, lower center distances for multiple-spindle arrangements. Diameter ranges not shown in the catalog can be provided upon request.

The single row bearings of the series N10 and N19 can support very high radial loads. The rollers are guided on the inner ring and separated using a brass cage or a PEEK cage.

The rollers on Double Row Cylindrical Roller Bearings of the series NN30

are guided on the inner ring. The outer ring is ground cylindrical and is removable. The series NNU49 is designed the opposite way. In this case, the inner ring is ground cylindrical and is removable. Roller guidance is on the outer ring.

The design of these bearings is indicated using the following standards:

- Accuracy class SP
- Tapered inner ring bore to radial clearance/preload setting (taper 1:12) by adjusting axial displacement on the tapered seating surface of the shaft); (per request) cylindrical inner ring bore
- Solid brass cage or PEEK cage
- Radial clearance C1.

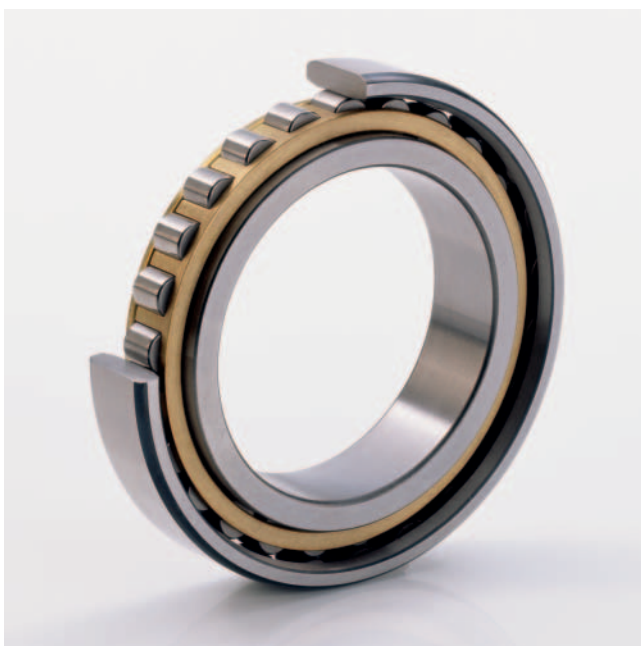

1: Single Row Super Precision Cylindrical Roller Bearings



2: Double Row Super Precision Cylindrical Roller Bearings

FAG Super Precision Cylindrical Roller Bearings

High Speed and Hybrid Cylindrical Roller Bearings

High Speed Cylindrical Roller Bearings

The internal design of N10...-HS bearings is modified so as to permit even higher speeds. They are designed with steel rollers and a PEEK cage and reach a speed level up to 60% higher than conventional Cylindrical Roller Bearings.

Hybrid Cylindrical Roller Bearings

The rollers in FAG Hybrid Cylindrical Roller Bearings are made of high performance ceramic. The use of ceramic rollers significantly reduces friction and wear in the bearing. This reduces the demand on the lubricant and leads to lower temperatures. The “HCN” design therefore yields the maximum speeds permissible in Cylindrical Roller Bearings. The lower coefficient of thermal expansion for ceramic rollers also mitigates an increase in preload at elevated temperatures. The service lives of spindles and machines are significantly extended by using Hybrid Cylindrical Roller Bearings, making the systems noticeably more cost-efficient. Furthermore, ceramic rollers also increase rigidity both statically and dynamically. This exerts a positive influence on the machining quality.



3: High Speed Cylindrical Roller Bearings (N...-HS...)



4: Hybrid Cylindrical Roller Bearings (HCN...)

FAG Super Precision Cylindrical Roller Bearings

High Speed and Hybrid Cylindrical Roller Bearings with half complement of rollers

Cylindrical Roller Bearings with half complement of rollers

Under specification H193, Hybrid Cylindrical Roller Bearings and High Speed Cylindrical Roller Bearings are manufactured standard with half the normal number of rollers. Reducing the number of rolling elements allows the speed of these Cylindrical Roller Bearings to be further increased, at the expense of reduced radial rigidity. These HCN...H193 and N10...HS...H193 Cylindrical Roller Bearings are utilized in high speed main spindles in machine tools.

Thanks to the high surface quality of ring raceways and rollers, FAG Cylindrical Roller Bearings are specially suited for grease lubrication. The bearing tolerances, requirements of the surrounding parts, clearance values and additional recommendations can be found in the table on the following pages. Single row Cylindrical Roller Bearings in Direct Lube design (DLR) are also available for oil-air lubrication. Detailed mounting instructions for Cylindrical Roller Bearings are in the "Mounting Guidelines" section (see Pages 204 ff.).



5: Hybrid Cylindrical Roller Bearings with half complement of rollers (HCN10...H193)



Bearing Code of FAG Super Precision Cylindrical Roller Bearings

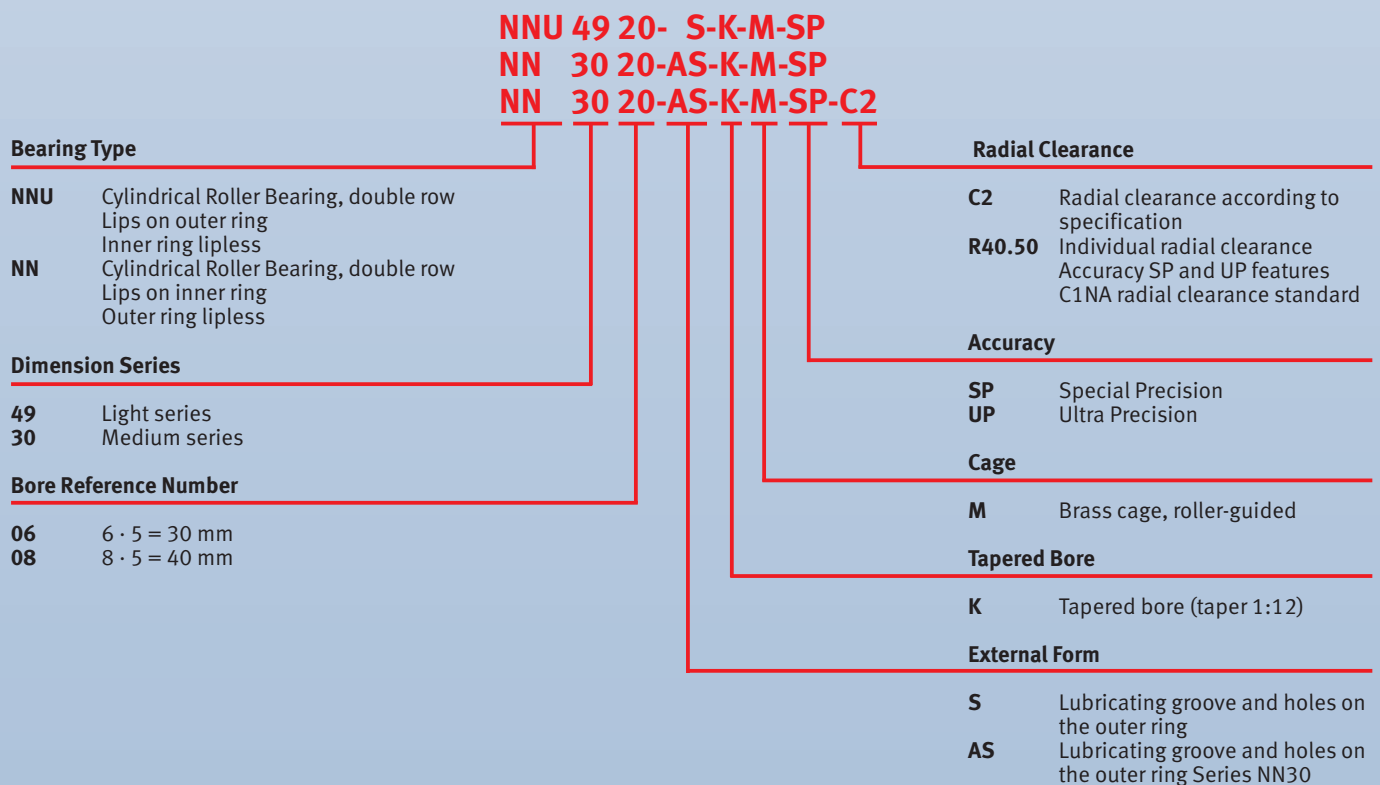
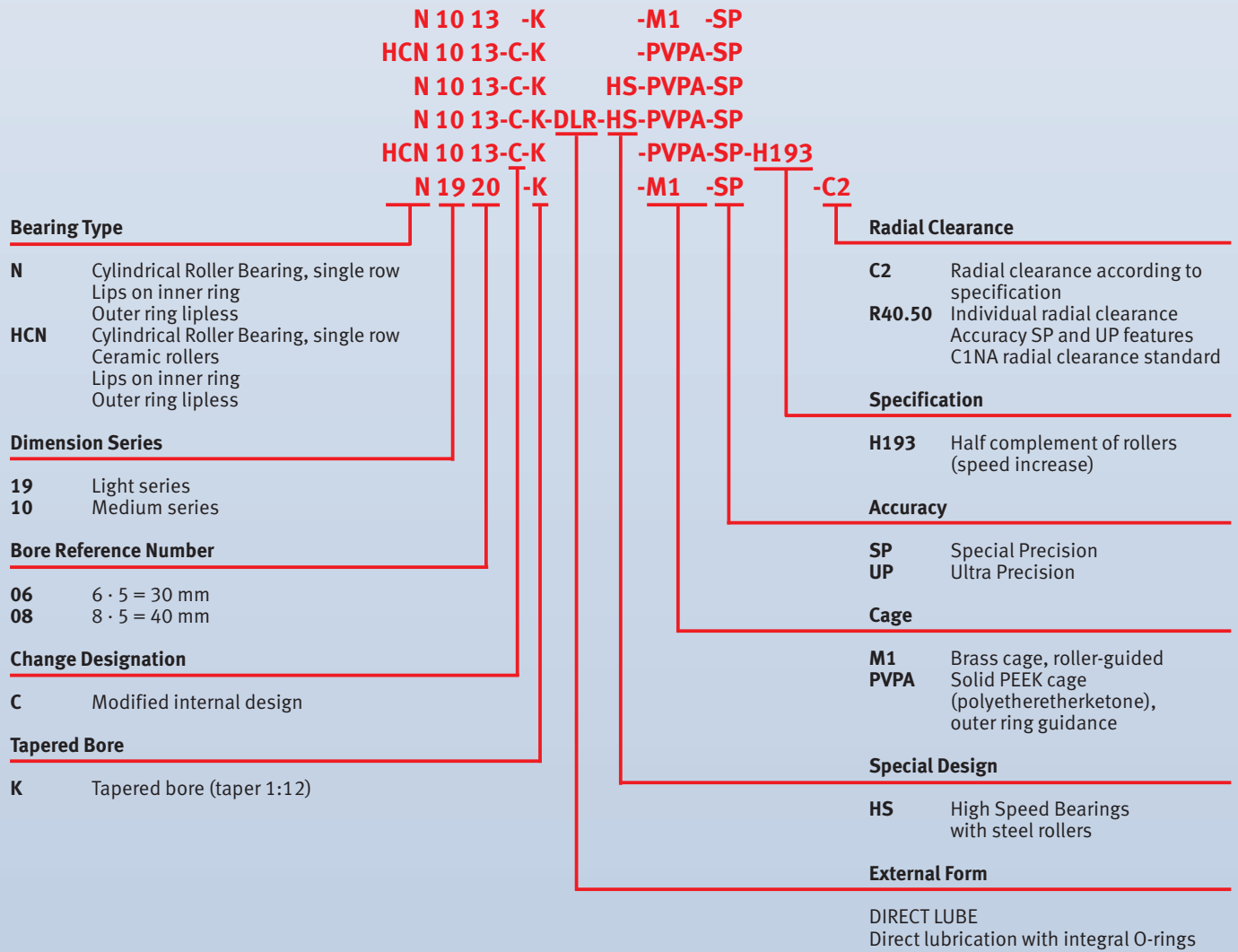

Bearing Marking of FAG Super Precision Cylindrical Roller Bearings

Cylindrical Roller Bearings, single row

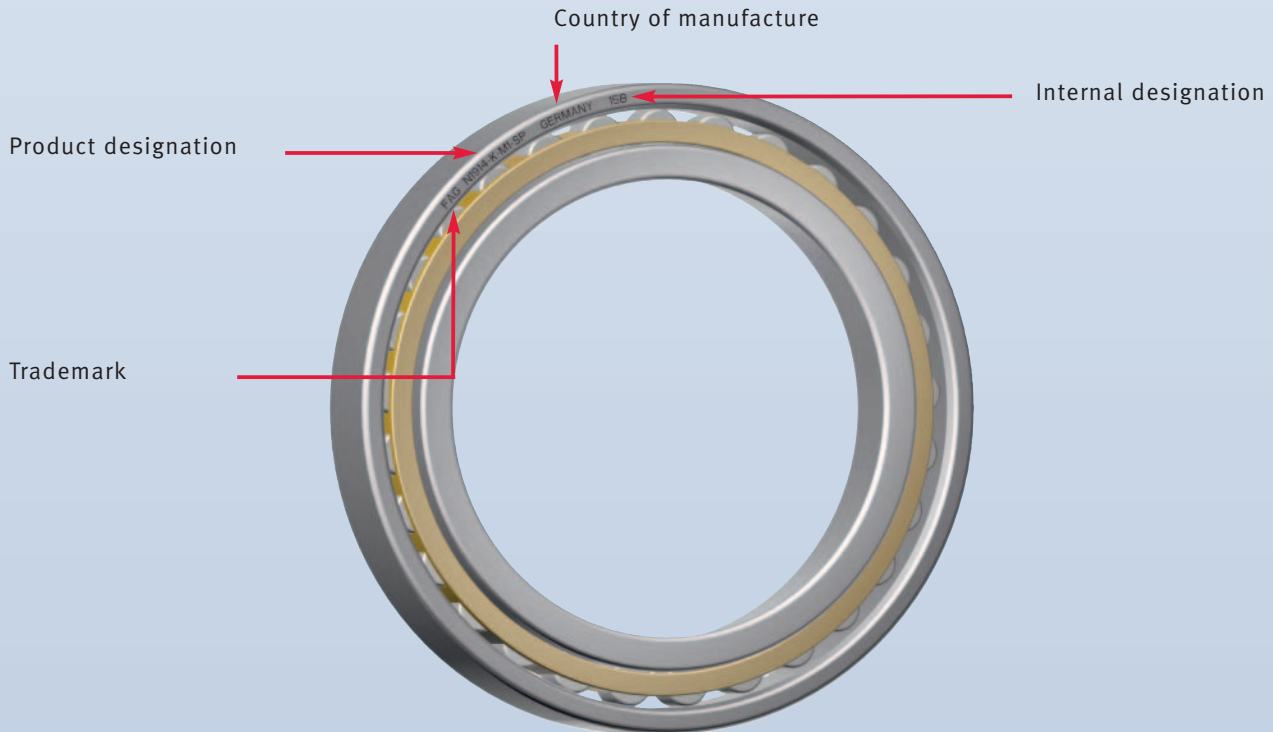

Cylindrical Roller Bearings, double row

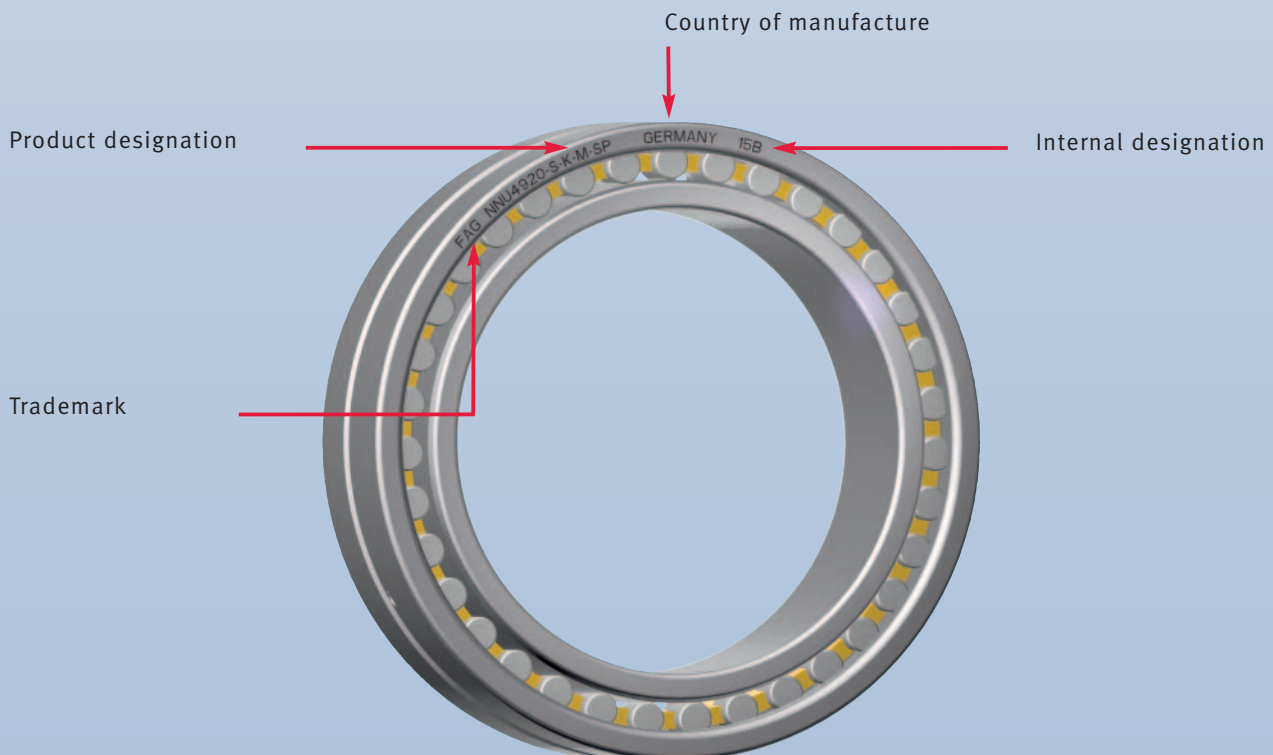

FAG Super Precision Cylindrical Roller Bearings

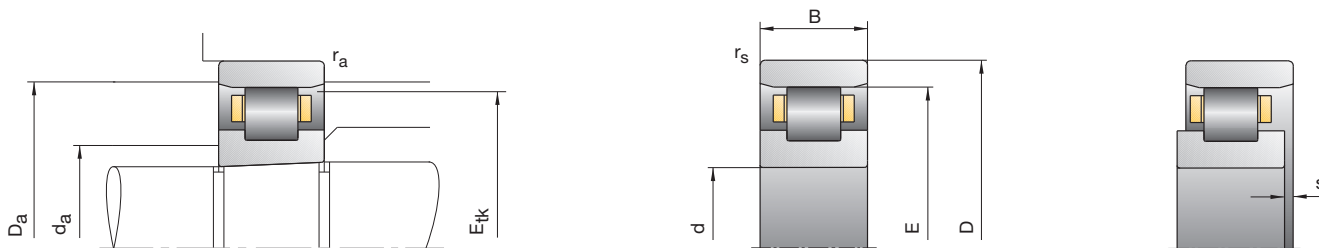

Bearing code	Dimensions						Abutment dimensions						
	d	D	B	r_{smin}	E	s	d_a h12	D_a H12	r_a max	B_N	S_N	S_B	E_{tk} nom.
FAG	mm												
N1006-K-M1-SP	30	55	13	0,6	48,5	1,9	36,5	49,4	0,6	2,8	7,2	1,4	47,0
N1006-K-PVPA-SP	30	55	13	0,6	48,5	1,9	36,5	49,4	0,6	2,8	7,2	1,4	39,7
N1006-K-HS-PVPA-SP	30	55	13	0,6	48,5	1,9	36,5	49,4	0,6	2,8	7,2	1,4	39,7
HCN1006-K-PVPA-SP	30	55	13	0,6	48,5	1,9	36,5	49,4	0,6	2,8	7,2	1,4	39,7
N1006-K-HS-PVPA-SP-H193	30	55	13	0,6	48,5	1,9	36,5	49,4	0,6	2,8	7,2	1,4	39,7
HCN1006-K-PVPA-SP-H193	30	55	13	0,6	48,5	1,9	36,5	49,4	0,6	2,8	7,2	1,4	39,7
N1007-K-M1-SP	35	62	14	0,6	55	2,0	42	56,1	0,6	2,8	8	1,4	53,4
N1007-C-K-PVPA-SP	35	62	14	0,6	55	2,0	43	56,1	0,6	2,8	8	1,4	45,8
N1007-C-K-HS-PVPA-SP	35	62	14	0,6	55	2,0	43	56,1	0,6	2,8	8	1,4	45,8
HCN1007-C-K-PVPA-SP	35	62	14	0,6	55	2,0	43	56,1	0,6	2,8	8	1,4	45,8
N1007-C-K-HS-PVPA-SP-H193	35	62	14	0,6	55	2,0	43	56,1	0,6	2,8	8	1,4	45,8
HCN1007-C-K-PVPA-SP-H193	35	62	14	0,6	55	2,0	43	56,1	0,6	2,8	8	1,4	45,8
N1008-K-M1-SP	40	68	15	0,6	61	2,1	47	62,1	0,6	2,8	8,5	1,4	59,3
N1008-K-PVPA-SP	40	68	15	0,6	61	2,1	47	62,1	0,6	2,8	8,5	1,4	50,8
N1008-K-HS-PVPA-SP	40	68	15	0,6	61	2,1	47	62,1	0,6	2,8	8,5	1,4	50,8
HCN1008-K-PVPA-SP	40	68	15	0,6	61	2,1	47	62,1	0,6	2,8	8,5	1,4	50,8
N1008-K-HS-PVPA-SP-H193	40	68	15	0,6	61	2,1	47	62,1	0,6	2,8	8,5	1,4	50,8
HCN1008-K-PVPA-SP-H193	40	68	15	0,6	61	2,1	47	62,1	0,6	2,8	8,5	1,4	50,8
N1009-K-M1-SP	45	75	16	0,6	67,5	2,2	52,5	68,6	0,6	3,4	9,3	1,4	65,6
N1009-C-K-PVPA-SP	45	75	16	0,6	67,5	2,2	53,5	68,7	0,6	3,4	9,3	1,4	56,9
N1009-C-K-HS-PVPA-SP	45	75	16	0,6	67,5	2,2	53,5	68,7	0,6	3,4	9,3	1,4	56,9
HCN1009-C-K-PVPA-SP	45	75	16	0,6	67,5	2,2	53,5	68,7	0,6	3,4	9,3	1,4	56,9
N1009-C-K-HS-PVPA-SP-H193	45	75	16	0,6	67,5	2,2	53,5	68,7	0,6	3,4	9,3	1,4	56,9
HCN1009-C-K-PVPA-SP-H193	45	75	16	0,6	67,5	2,2	53,5	68,7	0,6	3,4	9,3	1,4	56,9

Designation examples:

Standard design
N1009-K-M1-SP

Cylindrical bore
N1009-M1-SP

High Speed design
N1009-C-K-HS-PVPA-SP
N1009-C-K-HS-PVPA-SP-H193

N10, N19, HCN10

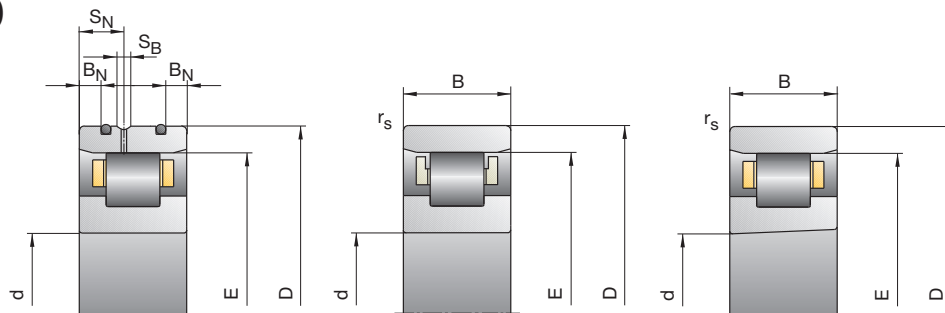

Load rating		Attainable speed		Radial rigidity	Weight	Bearing code
C _{dyn}	C _{0stat}	Grease	Oil	C _r		
kN		min ⁻¹	minimal	N/μm	kg	FAG
20,40	20,40	20000	24 000	370	0,13	N1006-K-M1-SP
20,40	20,40	30000	34 000	370	0,13	N1006-K-PVPA-SP
17,00	16,30	34000	38 000	300	0,13	N1006-K-HS-PVPA-SP
19,00	17,10	38000	43 000	450	0,13	HCN1006-K-PVPA-SP
10,20	8,15	38000	43 000	150	0,12	N1006-K-HS-PVPA-SP-H193
11,30	8,60	43000	48 000	230	0,12	HCN1006-K-PVPA-SP-H193
23,60	24,50	18000	20 000	410	0,17	N1007-K-M1-SP
23,60	20,90	26000	30 000	370	0,17	N1007-C-K-PVPA-SP
19,80	16,70	30000	34 000	300	0,17	N1007-C-K-HS-PVPA-SP
18,80	17,50	32000	36 000	450	0,17	HCN1007-C-K-PVPA-SP
11,80	8,30	32000	36 000	150	0,16	N1007-C-K-HS-PVPA-SP-H193
11,20	8,70	38000	43 000	230	0,16	HCN1007-C-K-PVPA-SP-H193
28,50	30,50	16000	18 000	470	0,22	N1008-K-M1-SP
27,50	29,00	24000	28 000	440	0,22	N1008-K-PVPA-SP
23,60	24,00	26000	30 000	370	0,22	N1008-K-HS-PVPA-SP
25,50	24,30	30000	34 000	530	0,22	HCN1008-K-PVPA-SP
14,00	12,00	30000	34 000	190	0,21	N1008-K-HS-PVPA-SP-H193
15,30	12,10	34000	38 000	270	0,21	HCN1008-K-PVPA-SP-H193
33,50	37,50	15000	17 000	530	0,27	N1009-K-M1-SP
29,00	32,50	22000	26 000	490	0,27	N1009-C-K-PVPA-SP
25,50	27,00	24000	28 000	410	0,27	N1009-C-K-HS-PVPA-SP
27,50	27,50	26000	30 000	620	0,27	HCN1009-C-K-PVPA-SP
15,00	13,70	26000	30 000	210	0,26	N1009-C-K-HS-PVPA-SP-H193
16,30	13,70	30000	34 000	300	0,26	HCN1009-C-K-PVPA-SP-H193

Hybrid design

HCN1009-C-K-PVPA-SP
HCN1009-C-K-PVPA-SP-H193

Direct Lube design

N1009-C-K-DLR-M1-SP
N1009-C-K-DLR-PVPA-SP



30
-
45

FAG Super Precision Cylindrical Roller Bearings

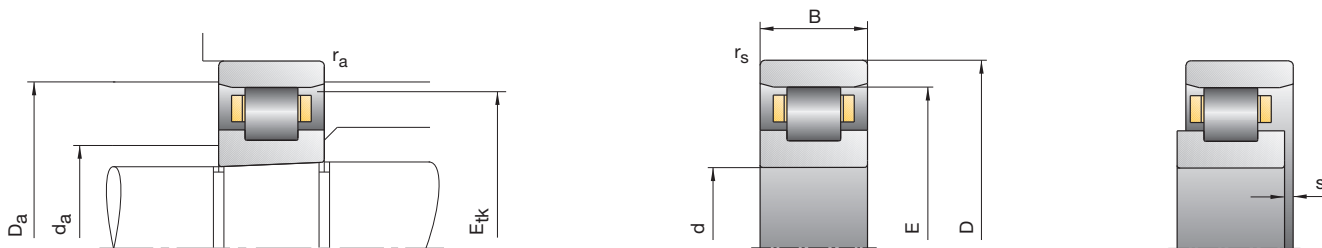

Bearing code	Dimensions						Abutment dimensions						
	d	D	B	r_{smin}	E	s	d_a h12	D_a H12	r_a max	B_N	S_N	S_B	E_{tk} nom.
FAG	mm												
N1910-K-M1-SP	50	72	12	0,6	66,5	1,8	55,5	67,0	0,6				65,1
N1010-K-M1-SP	50	80	16	0,6	72,5	2,2	57,5	73,6	0,6	3,4	9,3	1,4	70,6
N1010-C-K-PVPA-SP	50	80	16	0,6	72,5	2,2	58,5	73,7	0,6	3,4	9,3	1,4	61,9
N1010-C-K-HS-PVPA-SP	50	80	16	0,6	72,5	2,2	58,5	73,7	0,6	3,4	9,3	1,4	61,9
HCN1010-C-K-PVPA-SP	50	80	16	0,6	72,5	2,2	58,5	73,7	0,6	3,4	9,3	1,4	61,9
N1010-C-K-HS-PVPA-SP-H193	50	80	16	0,6	72,5	2,2	58,5	73,7	0,6	3,4	9,3	1,4	61,9
HCN1010-C-K-PVPA-SP-H193	50	80	16	0,6	72,5	2,2	58,5	73,7	0,6	3,4	9,3	1,4	61,9
N1911-K-M1-SP	55	80	13	1	73,5	1,9	61,5	74,0	1				72,0
N1011-K-M1-SP	55	90	18	1	80,5	2,5	64,5	81,8	1	4,3	9,7	1,4	78,5
N1011-K-PVPA-SP	55	90	18	1	80,5	2,5	64,5	81,8	1	4,3	9,7	1,4	68,8
N1011-K-HS-PVPA-SP	55	90	18	1	80,5	2,5	64,5	81,8	1	4,3	9,7	1,4	68,8
HCN1011-K-PVPA-SP	55	90	18	1	80,5	2,5	64,5	81,8	1	4,3	9,7	1,4	68,8
N1011-K-HS-PVPA-SP-H193	55	90	18	1	80,5	2,5	64,5	81,8	1	4,3	9,7	1,4	68,8
HCN1011-K-PVPA-SP-H193	55	90	18	1	80,5	2,5	64,5	81,8	1	4,3	9,7	1,4	68,8
N1912-K-M1-SP	60	85	13	1	78,5	1,9	66,5	79,0	1				77,0
N1012-K-M1-SP	60	95	18	1	85,5	2,5	69,5	86,8	1	4,3	9,7	1,4	83,5
N1012-K-PVPA-SP	60	95	18	1	85,5	2,5	69,5	86,8	1	4,3	9,7	1,4	73,8
N1012-K-HS-PVPA-SP	60	95	18	1	85,5	2,5	69,5	86,8	1	4,3	9,7	1,4	73,8
HCN1012-K-PVPA-SP	60	95	18	1	85,5	2,5	69,5	86,8	1	4,3	9,7	1,4	73,8
N1012-K-HS-PVPA-SP-H193	60	95	18	1	85,5	2,5	69,5	86,8	1	4,3	9,7	1,4	73,8
HCN1012-K-PVPA-SP-H193	60	95	18	1	85,5	2,5	69,5	86,8	1	4,3	9,7	1,4	73,8
N1913-K-M1-SP	65	90	13	1	83,5	1,9	71,5	84,0	1				82,0
N1013-K-M1-SP	65	100	18	1	90,5	2,5	74,5	91,8	1	4	10,4	1,4	88,5
N1013-C-K-PVPA-SP	65	100	18	1	91	2,5	75	92,3	1	4	10,4	1,4	77,8
N1013-C-K-HS-PVPA-SP	65	100	18	1	91	2,5	75	92,3	1	4	10,4	1,4	77,8
HCN1013-C-K-PVPA-SP	65	100	18	1	91	2,5	75	92,3	1	4	10,4	1,4	77,8
N1013-C-K-HS-PVPA-SP-H193	65	100	18	1	91	2,5	75	92,3	1	4	10,4	1,4	77,8
HCN1013-C-K-PVPA-SP-H193	65	100	18	1	91	2,5	75	92,3	1	4	10,4	1,4	77,8

Designation examples:

Standard design

N1012-K-M1-SP
N1912-K-M1-SP

Cylindrical bore

N1012-M1-SP
N1912-M1-SP

High Speed design

N1012-K-HS-PVPA-SP
N1012-K-HS-PVPA-SP-H193

N10, N19, HCN10

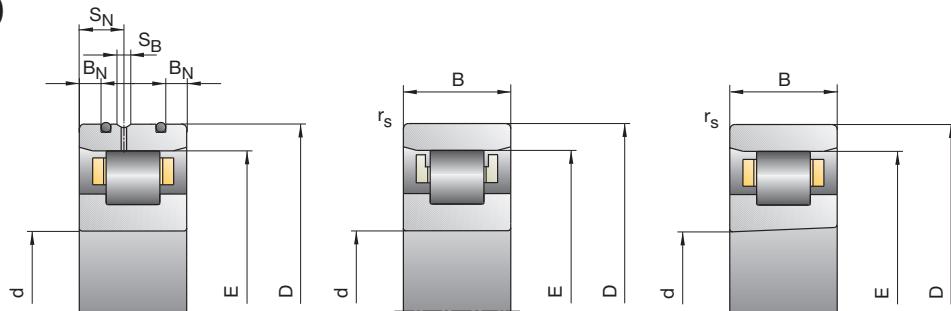

Load rating		Attainable speed		Radial rigidity	Weight	Bearing code
C _{dyn}	C _{0stat}	Grease	Oil	C _r		
kN		min ⁻¹	minimal	N/μm	kg	FAG
22,40	27,50	15 000	17 000	530	0,15	N1910-K-M1-SP
36,00	41,50	14 000	16 000	580	0,30	N1010-K-M1-SP
31,00	36,50	19 000	22 000	540	0,30	N1010-C-K-PVPA-SP
27,00	30,50	22 000	26 000	460	0,30	N1010-C-K-HS-PVPA-SP
29,00	30,50	24 000	28 000	650	0,30	HCN1010-C-K-PVPA-SP
16,00	15,00	24 000	28 000	230	0,29	N1010-C-K-HS-PVPA-SP-H193
17,30	15,20	28 000	32 000	330	0,29	HCN1010-C-K-PVPA-SP-H193
25,00	31,50	14 000	16 000	540	0,21	N1911-K-M1-SP
41,50	50,00	12 000	14 000	650	0,44	N1011-K-M1-SP
40,50	48,00	18 000	20 000	620	0,44	N1011-K-PVPA-SP
36,00	41,50	20 000	24 000	540	0,44	N1011-K-HS-PVPA-SP
38,00	40,50	22 000	26 000	780	0,44	HCN1011-K-PVPA-SP
21,20	20,80	22 000	26 000	270	0,43	N1011-K-HS-PVPA-SP-H193
22,60	20,20	26 000	30 000	370	0,43	HCN1011-K-PVPA-SP-H193
26,00	34,00	13 000	15 000	580	0,22	N1912-K-M1-SP
44,00	55,00	11 000	13 000	710	0,47	N1012-K-M1-SP
43,00	53,00	16 000	18 000	680	0,47	N1012-K-PVPA-SP
38,00	45,50	18 000	20 000	590	0,47	N1012-K-HS-PVPA-SP
40,50	44,50	20 000	24 000	820	0,47	HCN1012-K-PVPA-SP
22,40	22,80	20 000	24 000	290	0,46	N1012-K-HS-PVPA-SP-H193
23,90	22,20	24 000	28 000	410	0,46	HCN1012-K-PVPA-SP-H193
29,00	40,00	12 000	14 000	680	0,24	N1913-K-M1-SP
45,00	58,50	11 000	13 000	730	0,50	N1013-K-M1-SP
45,00	58,50	15 000	17 000	730	0,50	N1013-C-K-PVPA-SP
40,00	50,00	17 000	19 000	640	0,50	N1013-C-K-HS-PVPA-SP
42,50	48,50	19 000	22 000	890	0,50	HCN1013-C-K-PVPA-SP
23,60	25,00	19 000	22 000	320	0,49	N1013-C-K-HS-PVPA-SP-H193
25,00	24,30	22 000	26 000	440	0,49	HCN1013-C-K-PVPA-SP-H193

Hybrid design

HCN1012-K-PVPA-SP
HCN1012-K-PVPA-SP-H193

Direct Lube design

N1012-K-DLR-M1-SP
N1012-K-DLR-PVPA-SP

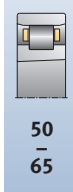

FAG Super Precision Cylindrical Roller Bearings

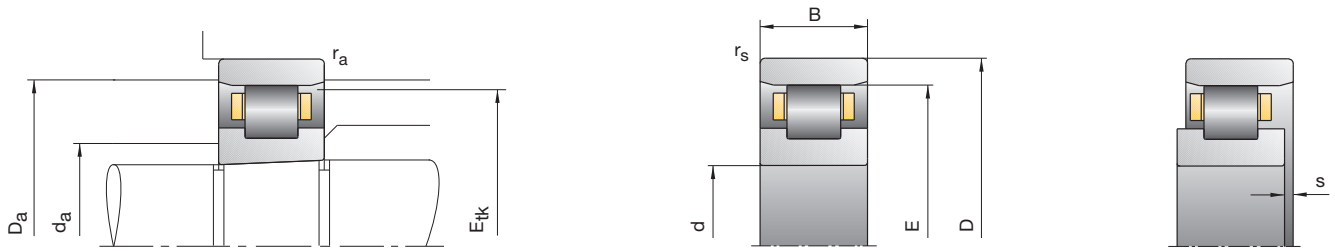

Bearing code	Dimensions						Abutment dimensions						
	d	D	B	r_{smin}	E	s	d_a h12	D_a H12	r_a max	B_N	S_N	S_B	E_{tk} nom.
FAG	mm												
N1914-K-M1-SP	70	100	16	1	92	2,3	78	93,0	1				90,3
N1014-K-M1-SP	70	110	20	1	100	2,5	80	101,3	1	4	11,6	1,4	97,5
N1014-K-PVPA-SP	70	110	20	1	100	2,5	80	101,3	1	4	11,6	1,4	85,4
N1014-K-HS-PVPA-SP	70	110	20	1	100	2,5	80	101,3	1	4	11,6	1,4	85,4
HCN1014-K-PVPA-SP	70	110	20	1	100	2,5	80	101,3	1	4	11,6	1,4	85,4
N1014-K-HS-PVPA-SP-H193	70	110	20	1	100	2,5	80	101,3	1	4	11,6	1,4	85,4
HCN1014-K-PVPA-SP-H193	70	110	20	1	100	2,5	80	101,3	1	4	11,6	1,4	85,4
N1915-K-M1-SP	75	105	16	1	97	2,3	83	98,0	1				95,3
N1015-K-M1-SP	75	115	20	1	105	2,5	85	106,3	1	4	11,6	1,4	102,5
N1015-K-PVPA-SP	75	115	20	1	105	2,5	85	106,3	1	4	11,6	1,4	90,4
N1015-K-HS-PVPA-SP	75	115	20	1	105	2,5	85	106,3	1	4	11,6	1,4	90,4
HCN1015-K-PVPA-SP	75	115	20	1	105	2,5	85	106,3	1	4	11,6	1,4	90,4
N1015-K-HS-PVPA-SP-H193	75	115	20	1	105	2,5	85	106,3	1	4	11,6	1,4	90,4
HCN1015-K-PVPA-SP-H193	75	115	20	1	105	2,5	85	106,3	1	4	11,6	1,4	90,4
N1916-K-M1-SP	80	110	16	1	102	2,3	88	103,0	1				100,3
N1016-K-M1-SP	80	125	22	1	113,5	3,0	91,5	115,0	1	4,7	12,2	2,2	110,8
N1016-K-PVPA-SP	80	125	22	1	113,5	3,0	91,5	115,0	1	4,7	12,2	2,2	97,4
N1016-K-HS-PVPA-SP	80	125	22	1	113,5	3,0	91,5	115,0	1	4,7	12,2	2,2	97,4
HCN1016-K-PVPA-SP	80	125	22	1	113,5	3,0	91,5	115,0	1	4,7	12,2	2,2	97,4
N1016-K-HS-PVPA-SP-H193	80	125	22	1	113,5	3,0	91,5	115,0	1	4,7	12,2	2,2	97,4
HCN1016-K-PVPA-SP-H193	80	125	22	1	113,5	3,0	91,5	115,0	1	4,7	12,2	2,2	97,4
N1917-K-M1-SP	85	120	18	1	110,5	2,5	94,5	112,0	1				108,5
N1017-K-M1-SP	85	130	22	1	118,5	3,0	96,5	120,0	1	4,7	12,2	2,2	115,8
N1017-K-PVPA-SP	85	130	22	1	118,5	3,0	96,5	120,0	1	4,7	12,2	2,2	102,4
N1017-K-HS-PVPA-SP	85	130	22	1	118,5	3,0	96,5	120,0	1	4,7	12,2	2,2	102,4
HCN1017-K-PVPA-SP	85	130	22	1	118,5	3,0	96,5	120,0	1	4,7	12,2	2,2	102,4
N1017-K-HS-PVPA-SP-H193	85	130	22	1	118,5	3,0	96,5	120,0	1	4,7	12,2	2,2	102,4
HCN1017-K-PVPA-SP-H193	85	130	22	1	118,5	3,0	96,5	120,0	1	4,7	12,2	2,2	102,4

Designation examples:

Standard design

N1014-K-M1-SP
N1914-K-M1-SP

Cylindrical bore

N1014-M1-SP
N1914-M1-SP

High Speed design

N1014-K-HS-PVPA-SP
N1014-K-HS-PVPA-SP-H193

N10, N19, HCN10

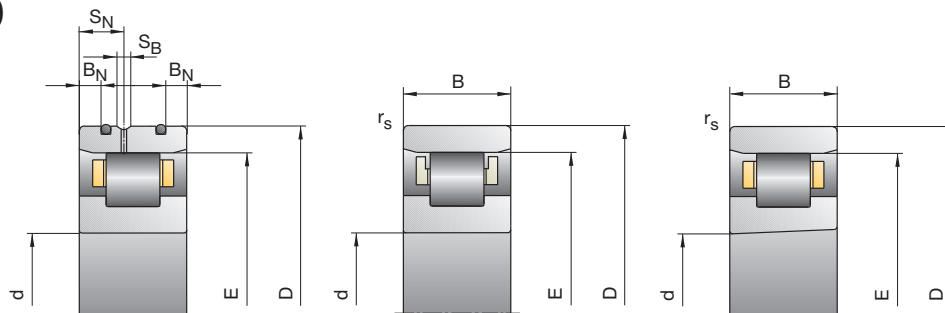

Load rating		Attainable speed		Radial rigidity	Weight	Bearing code
C _{dyn}	C _{0stat}	Grease	Oil	C _r		
kN		min ⁻¹	minimal	N/μm	kg	FAG
36,50	49,00	11 000	13 000	710	0,38	N1914-K-M1-SP
64,00	81,50	10 000	12 000	820	0,69	N1014-K-M1-SP
63,00	78,00	14 000	16 000	780	0,69	N1014-K-PVPA-SP
57,00	69,50	16 000	18 000	700	0,69	N1014-K-HS-PVPA-SP
57,00	63,00	18 000	20 000	920	0,69	HCN1014-K-PVPA-SP
34,00	34,50	18 000	20 000	350	0,67	N1014-K-HS-PVPA-SP-H193
34,00	31,50	20 000	24 000	460	0,67	HCN1014-K-PVPA-SP-H193
38,00	53,00	10 000	12 000	760	0,41	N1915-K-M1-SP
65,50	85,00	9 500	11 000	850	0,73	N1015-K-M1-SP
65,50	85,00	13 000	15 000	850	0,73	N1015-K-PVPA-SP
60,00	75,00	15 000	17 000	770	0,73	N1015-K-HS-PVPA-SP
61,00	69,00	17 000	19 000	1 000	0,72	HCN1015-K-PVPA-SP
36,00	38,00	17 000	19 000	380	0,71	N1015-K-HS-PVPA-SP-H193
36,00	34,50	19 000	22 000	500	0,71	HCN1015-K-PVPA-SP-H193
39,00	56,00	9 500	11 000	810	0,43	N1916-K-M1-SP
76,50	98,00	8 500	9 500	900	0,99	N1016-K-M1-SP
76,50	98,00	12 000	14 000	900	0,99	N1016-K-PVPA-SP
71,00	88,00	14 000	16 000	810	0,99	N1016-K-HS-PVPA-SP
72,00	83,00	15 000	17 000	1 080	0,98	HCN1016-K-PVPA-SP
41,50	44,00	15 000	17 000	410	0,97	N1016-K-HS-PVPA-SP-H193
43,00	41,50	18 000	20 000	540	0,97	HCN1016-K-PVPA-SP-H193
50,00	71,00	8 500	9 500	880	0,61	N1917-K-M1-SP
78,00	104,00	8 000	9 000	940	1,04	N1017-K-M1-SP
76,50	100,00	12 000	14 000	900	1,04	N1017-K-PVPA-SP
69,50	88,00	13 000	15 000	810	1,04	N1017-K-HS-PVPA-SP
72,00	83,00	15 000	17 000	1 080	1,03	HCN1017-K-PVPA-SP
41,50	44,00	15 000	17 000	410	1,02	N1017-K-HS-PVPA-SP-H193
42,50	41,50	17 000	19 000	540	1,02	HCN1017-K-PVPA-SP-H193

Hybrid design

HCN1014-K-PVPA-SP
HCN1014-K-PVPA-SP-H193

Direct Lube design

N1014-K-DLR-M1-SP
N1014-K-DLR-PVPA-SP



FAG Super Precision Cylindrical Roller Bearings

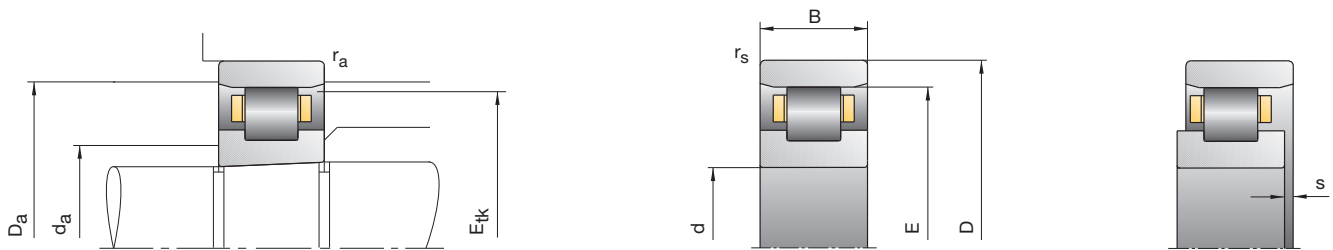

Bearing code	Dimensions						Abutment dimensions						
	d	D	B	r _{smin}	E	s	d _a h12	D _a H12	r _a max	B _N	S _N	S _B	E _{tk} nom.
FAG	mm												
N1918-K-M1-SP	90	125	18	1	115,5	2,5	99,5	117,0	1				113,5
N1018-K-M1-SP	90	140	24	1,1	127	3,2	103	128,6	1,1	5,5	14,5	2,2	124,0
N1018-K-PVPA-SP	90	140	24	1,1	127	3,2	103	128,6	1,1	5,5	14,5	2,2	109,4
N1018-K-HS-PVPA-SP	90	140	24	1,1	127	3,2	103	128,6	1,1	5,5	14,5	2,2	109,4
HCN1018-K-PVPA-SP	90	140	24	1,1	127	3,2	103	128,6	1,1	5,5	14,5	2,2	109,4
N1018-K-HS-PVPA-SP-H193	90	140	24	1,1	127	3,2	103	128,6	1,1	5,5	14,5	2,2	109,4
HCN1018-K-PVPA-SP-H193	90	140	24	1,1	127	3,2	103	128,6	1,1	5,5	14,5	2,2	109,4
N1919-K-M1-SP	95	130	18	1	120,5	2,5	104,5	122,0	1				118,5
N1019-K-M1-SP	95	145	24	1,1	132	3,2	108	133,6	1,1	5,5	14,5	2,2	129,0
N1019-K-PVPA-SP	95	145	24	1,1	132	3,2	108	133,6	1,1	5,5	14,5	2,2	114,4
N1019-K-HS-PVPA-SP	95	145	24	1,1	132	3,2	108	133,6	1,1	5,5	14,5	2,2	114,4
HCN1019-K-PVPA-SP	95	145	24	1,1	132	3,2	108	133,6	1,1	5,5	14,5	2,2	114,4
N1019-K-HS-PVPA-SP-H193	95	145	24	1,1	132	3,2	108	133,6	1,1	5,5	14,5	2,2	114,4
HCN1019-K-PVPA-SP-H193	95	145	24	1,1	132	3,2	108	133,6	1,1	5,5	14,5	2,2	114,4
N1920-K-M1-SP	100	140	20	1	130	2,5	110	132,0	1				127,5
N1020-K-M1-SP	100	150	24	1,1	137	3,2	113	138,6	1,1	5,5	14,5	2,2	134,0
N1020-K-PVPA-SP	100	150	24	1,1	137	3,2	113	138,6	1,1	5,5	14,5	2,2	119,4
N1020-K-HS-PVPA-SP	100	150	24	1,1	137	3,2	113	138,6	1,1	5,5	14,5	2,2	119,4
HCN1020-K-PVPA-SP	100	150	24	1,1	137	3,2	113	138,6	1,1	5,5	14,5	2,2	119,4
N1020-K-HS-PVPA-SP-H193	100	150	24	1,1	137	3,2	113	138,6	1,1	5,5	14,5	2,2	119,4
HCN1020-K-PVPA-SP-H193	100	150	24	1,1	137	3,2	113	138,6	1,1	5,5	14,5	2,2	119,4
N1921-K-M1-SP	105	145	20	1	135	2,5	115	137,0	1				132,5
N1021-K-M1-SP	105	160	26	1,1	145,5	3,4	119,5	147,2	1,1	6	15,2	2,2	142,3
N1021-K-PVPA-SP	105	160	26	1,1	145,5	3,4	119,5	147,2	1,1	6	15,2	2,2	126,5
N1021-K-HS-PVPA-SP	105	160	26	1,1	145,5	3,4	119,5	147,2	1,1	6	15,2	2,2	126,5
HCN1021-K-PVPA-SP	105	160	26	1,1	145,5	3,4	119,5	147,2	1,1	6	15,2	2,2	126,5
N1021-K-HS-PVPA-SP-H193	105	160	26	1,1	145,5	3,4	119,5	147,2	1,1	6	15,2	2,2	126,5
HCN1021-K-PVPA-SP-H193	105	160	26	1,1	145,5	3,4	119,5	147,2	1,1	6	15,2	2,2	126,5

Designation examples:

Standard design

N1019-K-M1-SP
N1919-K-M1-SP

Cylindrical bore

N1019-M1-SP
N1919-M1-SP

High Speed design

N1019-K-HS-PVPA-SP
N1019-K-HS-PVPA-SP-H193

N10, N19, HCN10

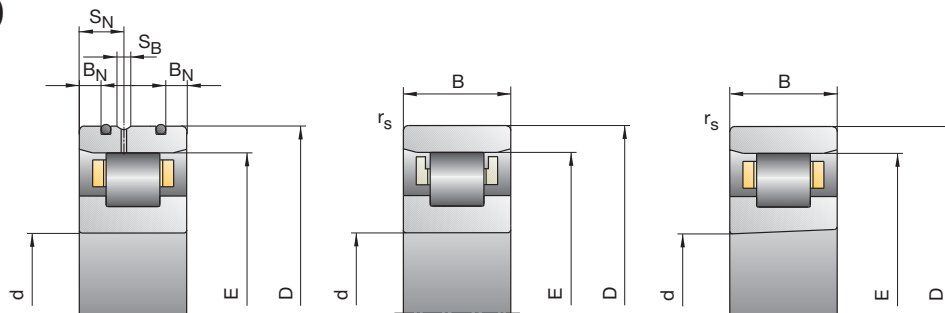

Load rating		Attainable speed		Radial rigidity	Weight	Bearing code
C _{dyn}	C _{0stat}	Grease	Oil	C _r		
kN		min ⁻¹	minimal	N/μm	kg	FAG
51,00	75,00	8 500	9 500	930	0,64	N1918-K-M1-SP
93,00	125,00	7 500	8 500	1 030	1,34	N1018-K-M1-SP
90,00	120,00	11 000	13 000	980	1,34	N1018-K-PVPA-SP
83,00	108,00	12 000	14 000	900	1,34	N1018-K-HS-PVPA-SP
85,00	100,00	13 000	15 000	1 190	1,33	HCN1018-K-PVPA-SP
50,00	54,00	13 000	15 000	450	1,32	N1018-K-HS-PVPA-SP-H193
51,00	50,00	15 000	17 000	590	1,32	HCN1018-K-PVPA-SP-H193
52,00	78,00	8 000	9 000	960	0,67	N1919-K-M1-SP
96,50	129,00	7 000	8 000	1 070	1,40	N1019-K-M1-SP
96,50	129,00	10 000	12 000	1 070	1,40	N1019-K-PVPA-SP
88,00	118,00	12 000	14 000	970	1,40	N1019-K-HS-PVPA-SP
90,00	109,00	13 000	15 000	1 290	1,39	HCN1019-K-PVPA-SP
53,00	58,50	13 000	15 000	490	1,38	N1019-K-HS-PVPA-SP-H193
54,00	54,00	15 000	17 000	640	1,38	HCN1019-K-PVPA-SP-H193
78,00	112,00	7 000	8 000	1 100	0,92	N1920-K-M1-SP
98,00	134,00	6 700	7 500	1 110	1,46	N1020-K-M1-SP
95,00	129,00	10 000	12 000	1 070	1,46	N1020-K-PVPA-SP
88,00	118,00	11 000	13 000	970	1,46	N1020-K-HS-PVPA-SP
90,00	109,00	12 000	14 000	1 290	1,45	HCN1020-K-PVPA-SP
52,00	58,50	12 000	14 000	490	1,44	N1020-K-HS-PVPA-SP-H193
53,00	55,00	14 000	16 000	640	1,44	HCN1020-K-PVPA-SP-H193
78,00	116,00	6 700	7 500	1 140	0,96	N1921-K-M1-SP
112,00	153,00	6 300	7 000	1 160	1,82	N1021-K-M1-SP
112,00	153,00	9 000	10 000	1 160	1,82	N1021-K-PVPA-SP
104,00	140,00	10 000	12 000	1 070	1,82	N1021-K-HS-PVPA-SP
104,00	128,00	11 000	13 000	1 390	1,81	HCN1021-K-PVPA-SP
62,00	71,00	11 000	13 000	530	1,80	N1021-K-HS-PVPA-SP-H193
62,00	64,00	13 000	15 000	690	1,80	HCN1021-K-PVPA-SP-H193

Hybrid design

HCN1019-K-PVPA-SP
HCN1019-K-PVPA-SP-H193

Direct Lube design

N1019-K-DLR-M1-SP
N1019-K-DLR-PVPA-SP

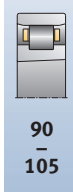

FAG Super Precision Cylindrical Roller Bearings

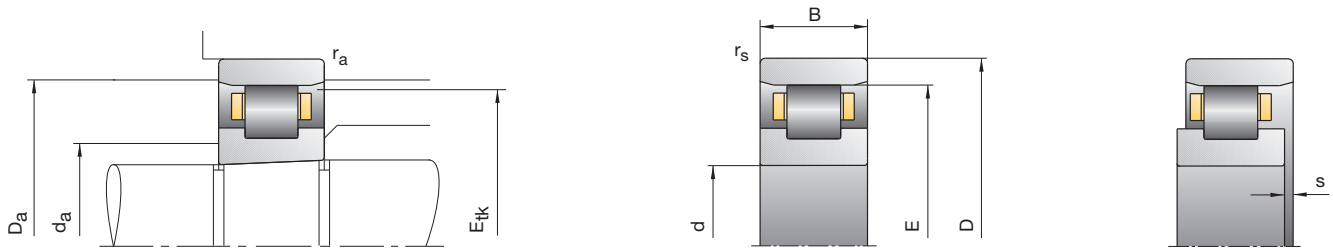

Bearing code	Dimensions						Abutment dimensions							
	d	D	B	r _{smin}	E	s	d _a h12	D _a H12	r _a max	B _N	S _N	S _B	E _{tk} nom.	
FAG	mm													
N1922-K-M1-SP	110	150	20	1	140	2,5	120	142,0	1				137,5	
N1022-K-M1-SP	110	170	28	1,1	155	3,4	125	156,7	1,1	6	16,2	2,2	151,3	
N1022-K-PVPA-SP	110	170	28	1,1	155	3,4	125	156,7	1,1	6	16,2	2,2	133,1	
N1022-K-HS-PVPA-SP	110	170	28	1,1	155	3,4	125	156,7	1,1	6	16,2	2,2	133,1	
HCN1022-K-PVPA-SP	110	170	28	1,1	155	3,4	125	156,7	1,1	6	16,2	2,2	133,1	
N1022-K-HS-PVPA-SP-H193	110	170	28	1,1	155	3,4	125	156,7	1,1	6	16,2	2,2	133,1	
HCN1022-K-PVPA-SP-H193	110	170	28	1,1	155	3,4	125	156,7	1,1	6	16,2	2,2	133,1	
N1924-K-M1-SP	120	165	22	1	153,5	3,0	131,5	156,0	1				150,8	
N1024-K-M1-SP	120	180	28	1,1	165	3,4	135	166,7	1,1	6	16,2	2,2	161,3	
N1024-K-PVPA-SP	120	180	28	1,1	165	3,4	135	166,7	1,1	6	16,2	2,2	143,1	
N1024-K-HS-PVPA-SP	120	180	28	1,1	165	3,4	135	166,7	1,1	6	16,2	2,2	143,1	
HCN1024-K-PVPA-SP	120	180	28	1,1	165	3,4	135	166,7	1,1	6	16,2	2,2	143,1	
N1024-K-HS-PVPA-SP-H193	120	180	28	1,1	165	3,4	135	166,7	1,1	6	16,2	2,2	143,1	
HCN1024-K-PVPA-SP-H193	120	180	28	1,1	165	3,4	135	166,7	1,1	6	16,2	2,2	143,1	
N1926-K-M1-SP	130	180	24	1,1	167	3,2	143	170,0	1,1				164,0	
N1026-K-M1-SP	130	200	33	1,1	182	4,2	148	184,1	1,1				177,8	
N1928-K-M1-SP	140	190	24	1,1	177	3,2	153	180,0	1,1				174,0	
N1028-K-M1-SP	140	210	33	1,1	192	4,2	158	194,1	1,1				187,8	
N1930-K-M1-SP	150	210	28	1,1	194	3,6	166	197,0	1,1				190,5	
N1030-K-M1-SP	150	225	35	1,5	205,5	4,4	169,5	207,8	1,5				201,0	
N1932-K-M1-SP	160	220	28	1,1	204	3,6	176	206,0	1,1				200,5	
N1032-K-M1-SP	160	240	38	1,5	220	4,6	180	222,4	1,5				215,0	
N1934-K-M1-SP	170	230	28	1,1	214	3,6	186	216,0	1,1				210,5	
N1034-K-M1-SP	170	260	42	2,1	237	5,0	193	239,7	2,1				231,5	
N1936-K-M1-SP	180	250	33	1,1	232	4,2	198	234,0	1,1				227,8	
N1036-K-M1-SP	180	280	46	2,1	255	5,6	205	257,8	2,1				248,8	

Designation examples:

Standard design

N1024-K-M1-SP
N1924-K-M1-SP

Cylindrical bore

N1024-M1-SP
N1924-M1-SP

High Speed design

N1024-K-HS-PVPA-SP
N1024-K-HS-PVPA-SP-H193

N10, N19, HCN10

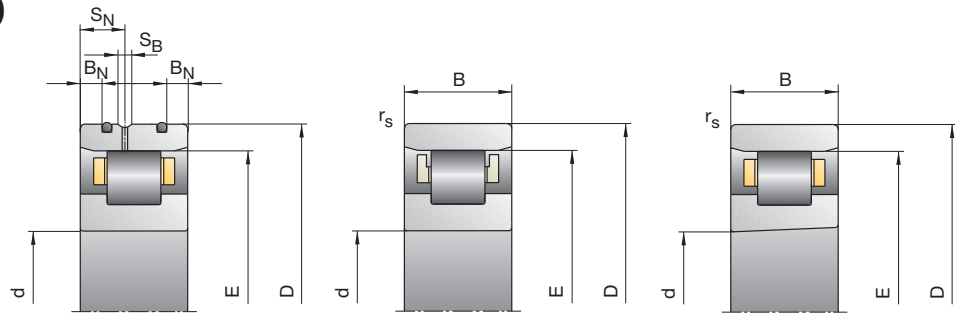

Load rating		Attainable speed		Radial rigidity	Weight	Bearing code
C _{dyn}	C _{0stat}	Grease	Oil	C _r		
kN		min ⁻¹	minimal	N/μm	kg	FAG
80,00	120,00	6700	7500	1170	0,99	N1922-K-M1-SP
165,00	190,00	6000	6700	1240	2,30	N1022-K-M1-SP
165,00	190,00	8500	9500	1230	2,30	N1022-K-PVPA-SP
156,00	175,00	9500	11000	1150	2,30	N1022-K-HS-PVPA-SP
132,00	159,00	11000	13000	1490	2,29	HCN1022-K-PVPA-SP
93,00	88,00	11000	13000	570	2,28	N1022-K-HS-PVPA-SP-H193
78,00	79,00	12000	14000	740	2,28	HCN1022-K-PVPA-SP-H193
95,00	143,00	6000	6700	1270	1,36	N1924-K-M1-SP
174,00	207,00	5600	6300	1340	2,47	N1024-K-M1-SP
174,00	207,00	8000	9000	1340	2,47	N1024-K-PVPA-SP
164,00	192,00	9000	10000	1240	2,47	N1024-K-HS-PVPA-SP
138,00	173,00	10000	12000	1610	2,46	HCN1024-K-PVPA-SP
97,00	96,00	10000	12000	620	2,45	N1024-K-HS-PVPA-SP-H193
82,00	87,00	11000	13000	810	2,45	HCN1024-K-PVPA-SP-H193
110,00	170,00	5300	6000	1350	1,80	N1926-K-M1-SP
180,00	250,00	5000	5600	1420	3,72	N1026-K-M1-SP
116,00	186,00	4300	4800	1480	1,92	N1928-K-M1-SP
183,00	265,00	4500	5000	1480	3,94	N1028-K-M1-SP
150,00	236,00	4500	5000	1590	2,95	N1930-K-M1-SP
208,00	310,00	4300	4800	1630	4,75	N1030-K-M1-SP
153,00	250,00	4300	4800	1690	3,10	N1932-K-M1-SP
245,00	355,00	4000	4500	1680	5,79	N1032-K-M1-SP
160,00	265,00	3800	4300	1780	3,26	N1934-K-M1-SP
300,00	430,00	3600	4000	1860	7,77	N1034-K-M1-SP
208,00	335,00	3600	4000	1820	4,81	N1936-K-M1-SP
360,00	520,00	3400	3800	1960	10,20	N1036-K-M1-SP



Hybrid design

HCN1024-K-PVPA-SP
HCN1024-K-PVPA-SP-H193

Direct Lube design

N1024-K-DLR-M1-SP
N1024-K-DLR-PVPA-SP

FAG Super Precision Cylindrical Roller Bearings

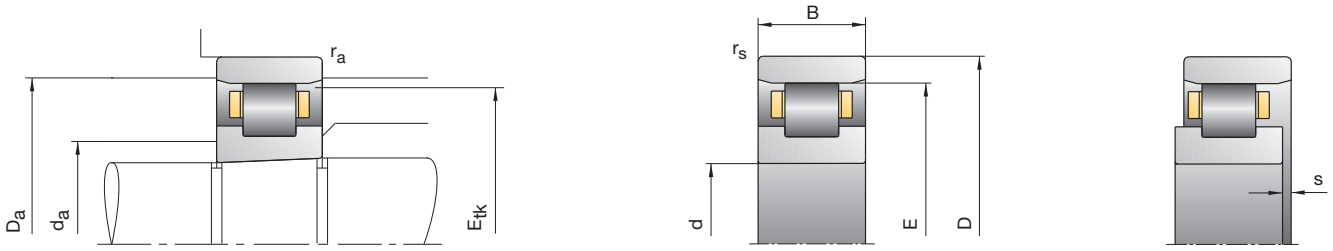

Bearing code	Dimensions						Abutment dimensions						
	d	D	B	r_{smin}	E	s	d_a h12	D_a H12	r_a max	B_N	S_N	S_B	E_{tk} nom.
FAG	mm												
N1938-K-M1-SP	190	260	33	1,1	242	4,2	208	244,0	1,1				237,8
N1038-K-M1-SP	190	290	46	2,1	265	5,6	215	267,8	2,1				258,8
N1940-K-M1-SP	200	280	38	1,5	259	4,8	221	261,0	1,5				254,3
N1040-K-M1-SP	200	310	51	2,1	281	6,4	229	284,3	2,1				274,5
N1944-K-M1-SP	220	300	38	1,5	279	4,8	241	281,0	1,5				274,3
N1044-K-M1-SP	220	340	56	3	310	6,6	250	313,5	3				302,5
N1948-K-M1-SP	240	320	38	1,5	299	4,8	261	301,0	1,5				294,3
N1048-K-M1-SP	240	360	56	3	330	6,6	270	333,5	3				322,5
N1952-K-M1-SP	260	360	46	1,5	334	5,4	286	336,0	1,5				328,0
N1052-K-M1-SP	260	400	65	4	364	8,1	296	368,2	4				355,5
N1956-K-M1-SP	280	380	46	1,5	354	5,4	306	356,0	1,5				348,0
N1056-K-M1-SP	280	420	65	4	384	8,1	316	388,2	4				375,5
N1960-K-M1-SP	300	420	56	3	390	6,6	330	392,0	3				382,5
N1060-K-M1-SP	300	460	74	4	420	8,7	340	424,6	4				410,0
N1964-K-M1-SP	320	440	56	3	410	6,6	350	412,0	3				402,5
N1064-K-M1-SP	320	480	74	4	440	8,7	360	444,6	4				430,0
N1968-K-M1-SP	340	460	56	3	430	6,6	370	433,0	3				422,5
N1068-K-M1-SP	340	520	82	5	475	9,3	385	480,0	5				463,8
N1972-K-M1-SP	360	480	56	3	450	6,6	390	453,0	3				442,5
N1072-K-M1-SP	360	540	82	5	495	9,3	405	500,0	5				483,8
N1976-K-M1-SP	380	520	65	4	484	8,1	416	487,0	4				475,5
N1076-K-M1-SP	380	560	82	5	515	9,3	425	520,0	5				503,8

Designation examples:

Standard design

N1072-K-M1-SP

N1972-K-M1-SP

Cylindrical bore

N1072-M1-SP

N1972-M1-SP

N10, N19, HCN10

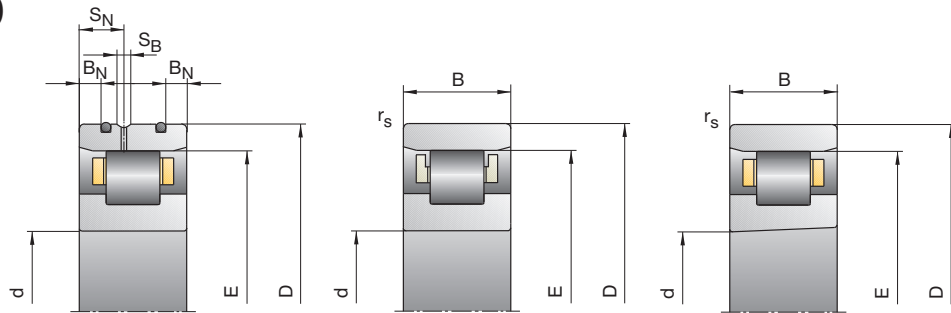

Load rating		Attainable speed		Radial rigidity	Weight	Bearing code
C _{dyn}	C _{0stat}	Grease	Oil minimal	C _r		
kN		min ⁻¹		N/μm	kg	FAG
220,00	365,00	3 400	3 800	1 990	5,05	N1938-K-M1-SP
365,00	550,00	3 200	3 600	2 040	10,60	N1038-K-M1-SP
265,00	430,00	3 200	3 600	2 110	7,07	N1940-K-M1-SP
400,00	600,00	3 000	3 400	2 130	14,00	N1040-K-M1-SP
265,00	450,00	3 000	3 400	2 170	7,64	N1944-K-M1-SP
510,00	765,00	2 600	3 000	2 360	17,90	N1044-K-M1-SP
285,00	500,00	2 800	3 200	2 430	8,24	N1948-K-M1-SP
540,00	850,00	2 400	2 800	2 560	19,30	N1048-K-M1-SP
430,00	750,00	2 400	2 800	2 840	14,00	N1952-K-M1-SP
655,00	1 020,00	2 200	2 600	2 710	28,60	N1052-K-M1-SP
440,00	800,00	2 200	2 600	3 000	14,90	N1956-K-M1-SP
680,00	1 100,00	2 000	2 400	2 930	30,90	N1056-K-M1-SP
610,00	1 060,00	1 900	2 200	3 150	23,60	N1960-K-M1-SP
900,00	1 430,00	1 800	2 000	3 200	43,70	N1060-K-M1-SP
620,00	1 100,00	1 800	2 000	3 250	24,90	N1964-K-M1-SP
915,00	1 500,00	1 700	1 900	3 330	45,10	N1064-K-M1-SP
655,00	1 200,00	1 700	1 900	3 550	26,30	N1968-K-M1-SP
1 120,00	1 830,00	1 600	1 800	3 610	60,70	N1068-K-M1-SP
655,00	1 220,00	1 600	1 800	3 640	27,50	N1972-K-M1-SP
1 140,00	1 900,00	1 500	1 700	3 750	64,40	N1072-K-M1-SP
815,00	1 500,00	1 500	1 700	3 900	40,00	N1976-K-M1-SP
1 180,00	2 000,00	1 400	1 600	3 900	66,60	N1076-K-M1-SP

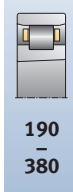

N10, N19, HCN10

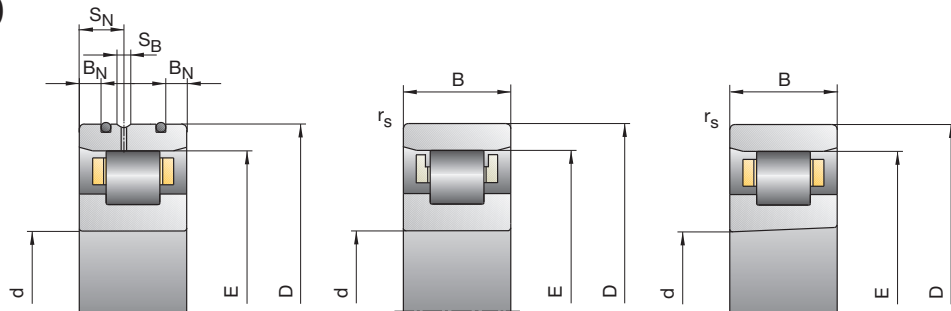

Load rating		Attainable speed		Radial rigidity	Weight	Bearing code
C _{dyn}	C _{0stat}	Grease	Oil minimal	C _r		
kN		min ⁻¹		N/μm	kg	FAG
815,00	1 560,00	1 500	1 700	4 100	41,70	N1980-K-M1-SP
1 370,00	2 320,00	1 300	1 500	4 090	88,10	N1080-K-M1-SP
850,00	1 630,00	1 400	1 600	4 230	43,50	N1984-K-M1-SP
1 400,00	2 450,00	1 300	1 500	4 240	90,70	N1084-K-M1-SP
1 020,00	1 960,00	1 300	1 500	4 500	60,20	N1988-K-M1-SP
1 560,00	2 750,00	1 200	1 400	4 580	106,00	N1088-K-M1-SP
1 060,00	2 080,00	1 300	1 500	4 740	62,60	N1992-K-M1-SP
1 660,00	3 000,00	1 100	1 300	4 760	120,00	N1092-K-M1-SP
1 140,00	2 240,00	1 200	1 400	4 870	73,10	N1996-K-M1-SP
1 700,00	3 100,00	1 100	1 300	4 930	125,00	N1096-K-M1-SP
1 180,00	2 360,00	1 200	1 400	5 120	75,70	N19/500-K-M1-SP
1 760,00	3 200,00	1 000	1 200	5 100	130,00	N10/500-K-M1-SP



FAG Super Precision Cylindrical Roller Bearings

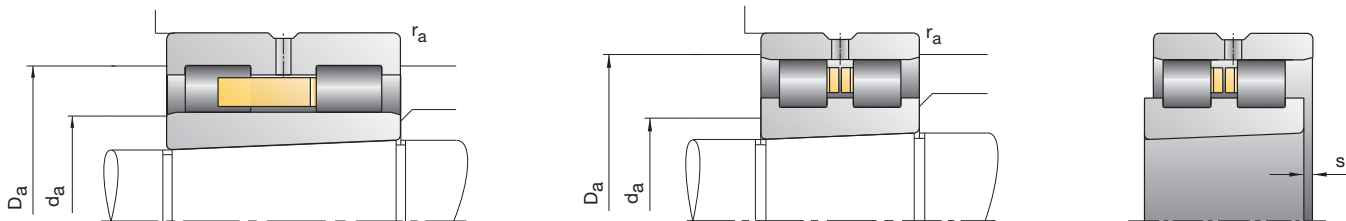

Bearing code	Dimensions									Abutment dimensions		
	d	D	B	r_{smin}	E	F	s	n_s	d_s	d_a h12	D_a H12	r_a max
FAG	mm											
NN3006-AS-K-M-SP	30	55	19	1,0	48,5		1,4	4,8	3,2	38	50	1,0
NN3007-AS-K-M-SP	35	62	20	1,0	55,0		1,4	4,8	3,2	43	57	1,0
NN3008-AS-K-M-SP	40	68	21	1,0	61,0		1,4	4,8	3,2	48	63	1,0
NN3009-AS-K-M-SP	45	75	23	1,0	67,5		1,7	4,8	3,2	54	69	1,0
NN3010-AS-K-M-SP	50	80	23	1,0	72,5		1,7	4,8	3,2	59	74	1,0
NN3011-AS-K-M-SP	55	90	26	1,1	81,0		1,9	4,8	3,2	65	83	1,1
NN3012-AS-K-M-SP	60	95	26	1,1	86,1		1,9	4,8	3,2	70	88	1,1
NN3013-AS-K-M-SP	65	100	26	1,1	91,0		1,9	4,8	3,2	75	93	1,1
NUU4914-S-K-M-SP	70	100	30	1,0		80,0	1,8	4,8	3,2	79	92	1,0
NN3014-AS-K-M-SP	70	110	30	1,1	100,0		2,3	6,5	3,2	82	102	1,1
NUU4915-S-K-M-SP	75	105	30	1,0		85,0	1,8	4,8	3,2	84	97	1,0
NN3015-AS-K-M-SP	75	115	30	1,1	105,0		2,3	6,5	3,2	87	107	1,1
NUU4916-S-K-M-SP	80	110	30	1,0		90,0	1,8	4,8	3,2	89	102	1,0
NN3016-AS-K-M-SP	80	125	34	1,1	113,0		2,5	6,5	3,2	93	116	1,1
NUU4917-S-K-M-SP	85	120	35	1,1		96,5	2,0	4,8	3,2	96	111	1,1
NN3017-AS-K-M-SP	85	130	34	1,1	118,0		2,5	6,5	3,2	98	121	1,1
NUU4918-S-K-M-SP	90	125	35	1,1		101,5	2,0	4,8	3,2	101	116	1,1
NN3018-AS-K-M-SP	90	140	37	1,5	127,0		2,6	6,5	3,2	105	130	1,5
NUU4919-S-K-M-SP	95	130	35	1,1		106,5	2,0	4,8	3,2	106	121	1,1
NN3019-AS-K-M-SP	95	145	37	1,5	132,0		2,6	6,5	3,2	110	135	1,5

See the “Mounting Guidelines” chapter for clearance adjustment of Cylindrical Roller Bearings

Designation examples

Standard design

NUU4918-S-K-M-SP
NN3018-AS-K-M-SP

Cylindrical bore

NUU4918-S-M-SP
NN3018-AS-M-SP

NN30, NNU49

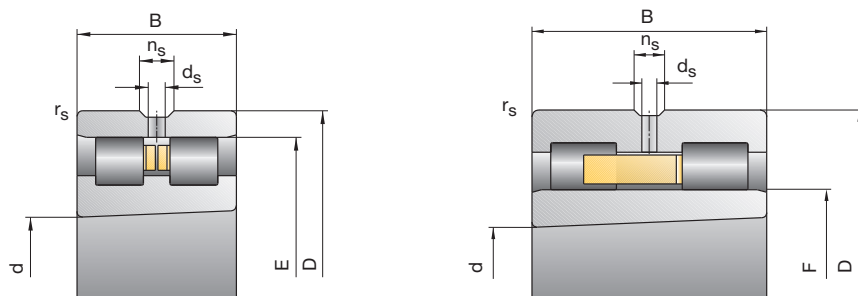

Load rating		Attainable speed		Radial rigidity	Weight	Bearing code
C _{dyn}	C _{0stat}	Grease	Oil minimal	C _r		
kN		min ⁻¹		N/μm	kg	FAG
29	34	16 000	19 000	680	0,19	NN3006-AS-K-M-SP
36	44	14 000	17 000	790	0,25	NN3007-AS-K-M-SP
45	59	12 000	15 000	950	0,30	NN3008-AS-K-M-SP
54	72	11 000	14 000	1 080	0,39	NN3009-AS-K-M-SP
57	80	10 000	13 000	1 180	0,43	NN3010-AS-K-M-SP
72	100	9 000	11 000	1 300	0,63	NN3011-AS-K-M-SP
75	110	8 500	10 000	1 410	0,67	NN3012-AS-K-M-SP
77	116	8 000	9 500	1 470	0,72	NN3013-AS-K-M-SP
60	104	7 500	9 000	1 700	0,73	NNU4914-S-K-M-SP
98	150	7 000	8 500	1 660	1,04	NN3014-AS-K-M-SP
63	114	7 000	8 500	1 870	0,77	NNU4915-S-K-M-SP
100	156	6 700	8 000	1 730	1,09	NN3015-AS-K-M-SP
66	122	6 700	8 000	1 980	0,81	NNU4916-S-K-M-SP
120	186	6 300	7 500	1 850	1,51	NN3016-AS-K-M-SP
90	166	6 300	7 500	2 280	1,20	NNU4917-S-K-M-SP
125	200	6 000	7 000	1 990	1,58	NN3017-AS-K-M-SP
93	176	6 000	7 000	2 420	1,26	NNU4918-S-K-M-SP
140	224	5 600	6 700	2 020	2,05	NN3018-AS-K-M-SP
95	186	5 600	6 700	2 560	1,32	NNU4919-S-K-M-SP
143	236	5 300	6 300	2 100	2,14	NN3019-AS-K-M-SP



FAG Super Precision Cylindrical Roller Bearings

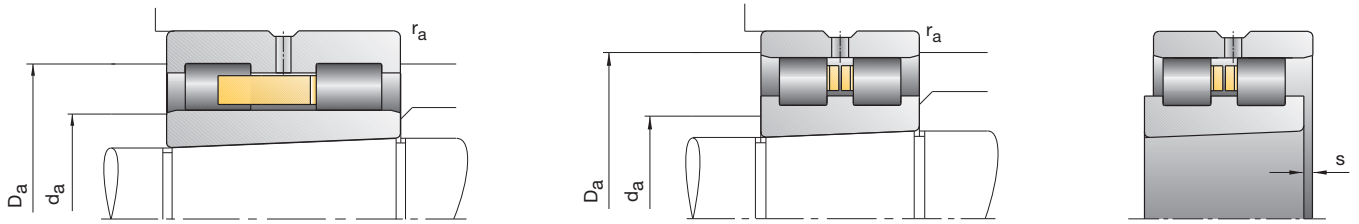

Bearing code	Dimensions									Abutment dimensions		
	d	D	B	r_{smin}	E	F	s	n_s	d_s	d_a h12	D_a H12	r_a max
FAG	mm											
NNU4920-S-K-M-SP	100	140	40	1,1		113,0	2,0	6,5	3,2	112	129	1,1
NN3020-AS-K-M-SP	100	150	37	1,5	137,0		2,6	6,5	3,2	115	140	1,5
NNU4921-S-K-M-SP	105	145	40	1,1		118,0	2,0	6,5	3,2	117	134	1,1
NN3021-AS-K-M-SP	105	160	41	2,0	146,0		2,6	6,5	3,2	120	149	2,0
NNU4922-S-K-M-SP	110	150	40	1,1		123,0	2,0	6,5	3,2	122	139	1,1
NN3022-AS-K-M-SP	110	170	45	2,0	155,0		2,9	6,5	3,2	127	158	2,0
NNU4924-S-K-M-SP	120	165	45	1,1		134,5	2,3	6,5	3,2	133	155	1,1
NN3024-AS-K-M-SP	120	180	46	2,0	165,0		3,1	6,5	3,2	137	168	2,0
NNU4926-S-K-M-SP	130	180	50	1,5		146,0	2,7	6,5	3,2	145	166	1,5
NN3026-AS-K-M-SP	130	200	52	2,0	182,0		3,1	9,5	4,8	150	186	2,0
NNU4928-S-K-M-SP	140	190	50	1,5		156,0	1,8	6,5	3,2	155	176	1,5
NN3028-AS-K-M-SP	140	210	53	2,0	192,0		3,4	9,5	4,8	160	196	2,0
NNU4930-S-K-M-SP	150	210	60	2,0		168,5	2,7	6,5	3,2	167	197	2,0
NN3030-AS-K-M-SP	150	225	56	2,1	206,0		3,8	9,5	4,8	172	210	2,1
NNU4932-S-K-M-SP	160	220	60	2,0		178,5	2,7	6,5	3,2	177	207	2,0
NN3032-AS-K-M-SP	160	240	60	2,1	219,0		4,3	9,5	4,8	183	224	2,1
NNU4934-S-K-M-SP	170	230	60	2,0		188,5	2,7	6,5	3,2	187	217	2,0
NN3034-AS-K-M-SP	170	260	67	2,1	236,0		4,6	9,5	4,8	196	241	2,1
NNU4936-S-K-M-SP	180	250	69	2,0		202,0	3,2	9,5	4,8	200	232	2,0
NN3036-AS-K-M-SP	180	280	74	2,1	255,0		4,8	12,2	6,3	209	260	2,1
NNU4938-S-K-M-SP	190	260	69	2,0		212,0	3,2	9,5	4,8	210	242	2,0
NN3038-AS-K-M-SP	190	290	75	2,1	265,0		4,8	12,2	6,3	219	271	2,1

See the “Mounting Guidelines” chapter for clearance adjustment of Cylindrical Roller Bearings

Designation examples

Standard design

NNU4934-S-K-M-SP
NN3034-AS-K-M-SP

Cylindrical bore

NNU4934-S-M-SP
NN3034-AS-M-SP

NN30, NNU49

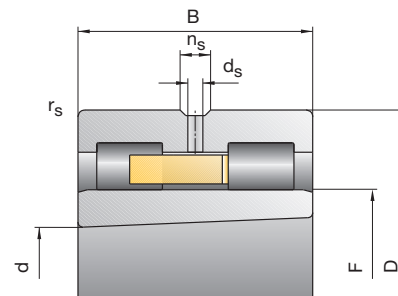
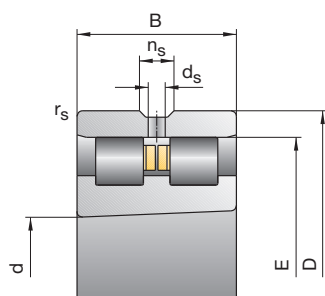

Load rating		Attainable speed		Radial rigidity	Weight	Bearing code
C_{dyn}	C_{0stat}	Grease	Oil minimal	C_r		
kN		min^{-1}		$N/\mu m$	kg	FAG
129	255	5 300	6 300	3 000	1,86	NNU4920-S-K-M-SP
146	245	5 300	6 300	2 170	2,23	NN3020-AS-K-M-SP
129	260	5 300	6 300	3 080	1,93	NNU4921-S-K-M-SP
190	310	4 800	5 600	2 320	2,84	NN3021-AS-K-M-SP
132	270	5 000	6 000	3 170	2,01	NNU4922-S-K-M-SP
220	360	4 500	5 300	2 500	3,61	NN3022-AS-K-M-SP
176	340	4 500	5 300	3 200	2,71	NNU4924-S-K-M-SP
232	390	4 300	5 000	2 700	3,94	NN3024-AS-K-M-SP
190	390	4 000	4 800	3 600	3,73	NNU4926-S-K-M-SP
290	500	3 800	4 500	2 980	5,79	NN3026-AS-K-M-SP
190	400	3 800	4 500	3 700	4,04	NNU4928-S-K-M-SP
300	520	3 600	4 300	3 090	6,22	NN3028-AS-K-M-SP
325	655	3 600	4 300	4 280	6,10	NNU4930-S-K-M-SP
335	585	3 400	4 000	3 300	7,58	NN3030-AS-K-M-SP
335	680	3 400	4 000	4 420	6,41	NNU4932-S-K-M-SP
375	670	3 200	3 800	3 510	9,23	NN3032-AS-K-M-SP
340	695	3 200	3 800	4 560	6,73	NNU4934-S-K-M-SP
450	800	3 000	3 600	3 770	12,50	NN3034-AS-K-M-SP
405	850	3 000	3 600	5 160	9,96	NNU4936-S-K-M-SP
570	1 000	2 800	3 400	4 040	16,40	NN3036-AS-K-M-SP
405	880	2 800	3 400	5 310	10,40	NNU4938-S-K-M-SP
585	1 040	2 600	3 200	4 190	17,30	NN3038-AS-K-M-SP

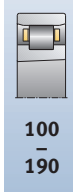

100
-
190

FAG Super Precision Cylindrical Roller Bearings

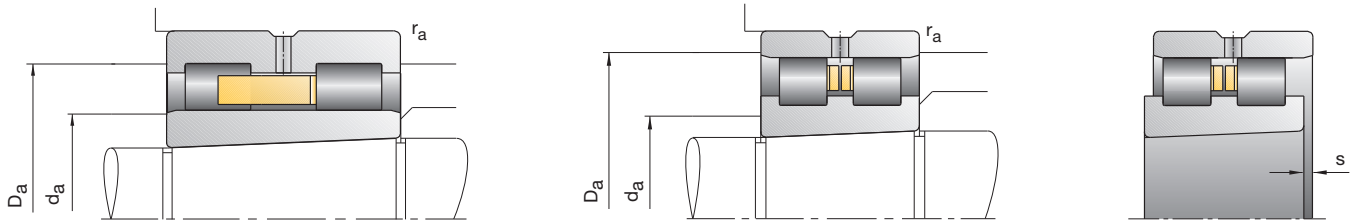

Bearing code	Dimensions									Abutment dimensions		
	d	D	B	r _{smin}	E	F	s	n _s	d _s	d _a h12	D _a H12	r _a max
FAG	mm											
NNU4940-S-K-M-SP	200	280	80	2,1		225,0	4,3	12,2	6,3	223	259	2,1
NN3040-AS-K-M-SP	200	310	82	2,1	282,0		5,7	12,2	6,3	232	288	2,1
NNU4944-S-K-M-SP	220	300	80	2,1		245,0	4,3	12,2	6,3	243	279	2,1
NN3044-AS-K-M-SP	220	340	90	3,0	310,0		5,7	15,0	8,0	254	317	3,0
NNU4948-S-K-M-SP	240	320	80	2,1		265,0	4,3	12,2	6,3	263	299	2,1
NN3048-AS-K-M-SP	240	360	92	3,0	330,0		6,1	15,0	8,0	274	337	3,0
NNU4952-S-K-M-SP	260	360	100	2,1		292,0	5,4	15,0	8,0	289	334	2,1
NN3052-AS-K-M-SP	260	400	104	4,0	364,0		6,6	15,0	8,0	300	372	4,0
NNU4956-S-K-M-SP	280	380	100	2,1		312,0	5,4	15,0	8,0	309	354	2,1
NN3056-AS-K-M-SP	280	420	106	4,0	384,0		6,9	15,0	8,0	320	392	4,0
NNU4960-S-K-M-SP	300	420	118	3,0		339,0	6,3	17,7	9,5	336	389	3,0
NN3060-AS-K-M-SP	300	460	118	4,0	418,0		7,5	17,7	9,5	346	427	4,0
NNU4964-S-K-M-SP	320	440	118	3,0		359,0	6,3	17,7	9,5	356	409	3,0
NN3064-AS-K-M-SP	320	480	121	4,0	438,0		8,0	17,7	9,5	366	447	4,0
NNU4968-S-K-M-SP	340	460	118	3,0		379,0	6,3	17,7	9,5	376	429	3,0
NN3068-AS-K-M-SP	340	520	133	5,0	473,0		8,8	17,7	9,5	393	483	5,0
NNU4972-S-K-M-SP	360	480	118	3,0		399,0	6,3	17,7	9,5	396	449	3,0
NN3072-AS-K-M-SP	360	540	134	5,0	493,0		8,8	17,7	9,5	413	503	5,0
NNU4976-S-K-M-SP	380	520	140	4,0		426,0	7,2	17,7	9,5	423	482	4,0
NN3076-AS-K-M-SP	380	560	135	5,0	513,0		9,1	17,7	9,5	433	523	5,0
NNU4980-S-K-M-SP	400	540	140	4,0		446,0	7,2	17,7	9,5	443	502	4,0
NN3080-AS-K-M-SP	400	600	148	5,0	549,0		9,5	17,7	9,5	459	560	5,0

See the “Mounting Guidelines” chapter for clearance adjustment of Cylindrical Roller Bearings

Designation examples

Standard design

NNU4976-S-K-M-SP
NN3076-AS-K-M-SP

Cylindrical bore

NNU4976-S-M-SP
NN3076-AS-M-SP

NN30, NNU49

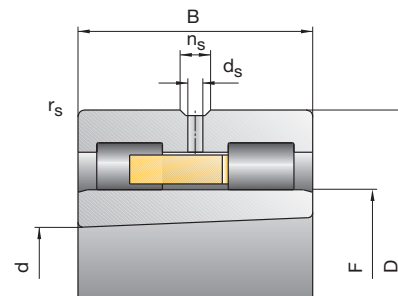
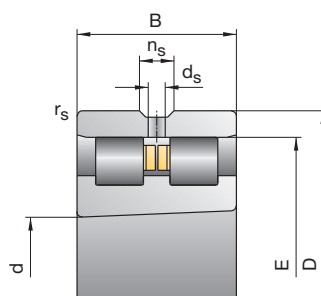

Load rating		Attainable speed		Radial rigidity	Weight	Bearing code
C_{dyn}	C_{0stat}	Grease	Oil minimal	C_r		
kN		min^{-1}		$N/\mu m$	kg	FAG
490	1 040	2 600	3 200	5 510	14,70	NNU4940-S-K-M-SP
655	1 200	2 400	3 000	4 410	22,20	NN3040-AS-K-M-SP
510	1 140	2 400	3 000	6 000	15,90	NNU4944-S-K-M-SP
800	1 460	2 200	2 800	4 770	29,10	NN3044-AS-K-M-SP
530	1 200	2 200	2 800	6 320	17,10	NNU4948-S-K-M-SP
850	1 560	2 000	2 600	5 140	31,60	NN3048-AS-K-M-SP
750	1 700	2 000	2 600	7 080	29,70	NNU4952-S-K-M-SP
1060	2 000	1 900	2 400	5 680	46,20	NN3052-AS-K-M-SP
765	1 800	1 900	2 400	7 480	31,60	NNU4956-S-K-M-SP
1080	2 080	1 800	2 200	5 890	49,70	NN3056-AS-K-M-SP
1040	2 400	1 700	2 000	8 280	49,10	NNU4960-S-K-M-SP
1270	2 400	1 600	1 900	5 930	68,80	NN3060-AS-K-M-SP
1060	2 550	1 600	1 900	8 750	51,80	NNU4964-S-K-M-SP
1320	2 600	1 600	1 900	6 440	74,20	NN3064-AS-K-M-SP
1100	2 650	1 500	1 800	9 230	54,50	NNU4968-S-K-M-SP
1630	3 250	1 400	1 700	7 170	99,30	NN3068-AS-K-M-SP
1140	2 800	1 500	1 800	9 700	57,30	NNU4972-S-K-M-SP
1660	3 350	1 400	1 700	7 430	104	NN3072-AS-K-M-SP
1430	3 600	1 400	1 700	10 970	85,80	NNU4976-S-K-M-SP
1700	3 450	1 300	1 600	7 690	110	NN3076-AS-K-M-SP
1500	3 800	1 300	1 600	11 540	89,40	NNU4980-S-K-M-SP
2160	4 500	1 200	1 500	8 660	143	NN3080-AS-K-M-SP



FAG Super Precision Cylindrical Roller Bearings

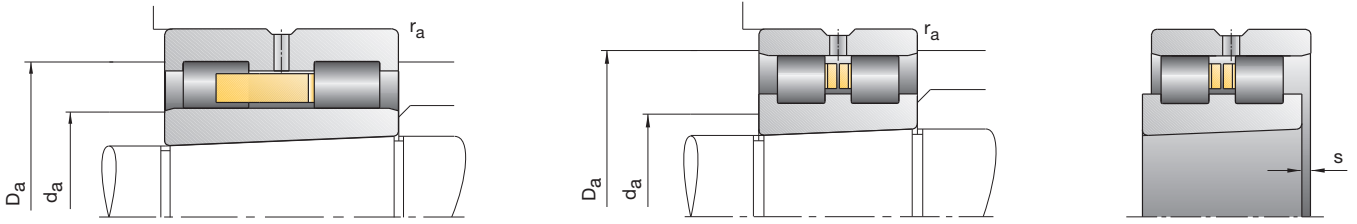

Bearing code	Dimensions									Abutment dimensions		
	d	D	B	r_{smin}	E	F	s	n_s	d_s	d_a h12	D_a H12	r_a max
FAG	mm											
NNU4984-S-K-M-SP	420	560	140	4,0		466,0	7,2	17,7	9,5	463	522	4,0
NN3084-AS-K-M-SP	420	620	150	5,0	569,0		10,0	17,7	9,5	479	580	5,0
NNU4988-S-K-M-SP	440	600	160	4,0		490,0	6,8	17,7	9,5	487	558	4,0
NN3088-AS-K-M-SP	440	650	157	6,0	597,0		10,2	23,5	12,5	501	609	6,0
NNU4992-S-K-M-SP	460	620	160	4,0		510,0	6,8	17,7	9,5	507	578	4,0
NN3092-AS-K-M-SP	460	680	163	6,0	624,0		10,9	23,5	12,5	524	636	6,0
NNU4996-S-K-M-SP	480	650	170	5,0		534,0	7,2	17,7	9,5	531	606	5,0
NN3096-AS-K-M-SP	480	700	165	6,0	644,0		11,2	23,5	12,5	544	656	6,0
NNU49/500-S-K-M-SP	500	670	170	5,0		568,0	7,2	17,7	9,5	551	626	5,0
NN30/500-AS-K-M-SP	500	720	167	6,0	664,0		11,7	23,5	12,5	564	677	6,0

See the "Mounting Guidelines" chapter for clearance adjustment of Cylindrical Roller Bearings

Designation examples

Standard design

NNU4992-S-K-M-SP
NN3092-AS-K-M-SP

Cylindrical bore

NNU4992-S-M-SP
NN3092-AS-M-SP

NN30, NNU49

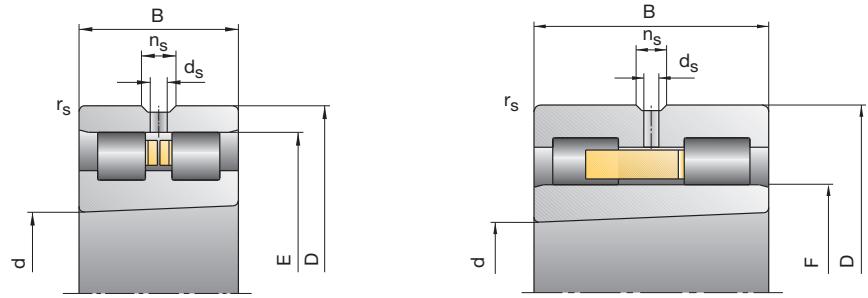

Load rating		Attainable speed		Radial rigidity	Weight	Bearing code
C _{dyn}	C _{0stat}	Grease	Oil minimal	C _r		
kN		min ⁻¹		N/μm	kg	FAG
1 530	4 000	1 300	1 600	12 120	93,20	NNU4984-S-K-M-SP
2 120	4 500	1 200	1 500	8 660	150	NN3084-AS-K-M-SP
2 040	5 200	1 200	1 500	12 690	129	NNU4988-S-K-M-SP
2 450	5 100	1 100	1 400	9 240	172	NN3088-AS-K-M-SP
2 120	5 500	1 100	1 400	13 390	134	NNU4992-S-K-M-SP
2 600	5 400	1 100	1 400	9 430	197	NN3092-AS-K-M-SP
2 360	6 100	1 100	1 400	14 110	158	NNU4996-S-K-M-SP
2 700	5 850	1 000	1 300	10 060	206	NN3096-AS-K-M-SP
2 320	6 100	1 000	1 300	14 110	162	NNU49/500-S-K-M-SP
2 650	5 850	1 000	1 300	10 060	214	NN30/500-AS-K-M-SP



420
-
500

FAG

Double Direction Angular Contact Thrust Ball Bearings



FAG Double Direction Angular Contact Thrust Ball Bearings were developed for the machine tool industry and are manufactured exclusively as high precision bearings. They accommodate axial loads in the main spindles of machine tools. They are matched to the abutment dimensions of the Double Row Cylindrical Roller Bearings of the NN30 series (Pages 116 ff.), which take up the radial forces.

External Dimensions

Double Direction Angular Contact Thrust Ball Bearings are mounted in combination with Double Row Radial Cylindrical Roller Bearings. The nominal outside diameters of the two bearings are identical. This facilitates the machining of the housing bore. The tolerance for the outside diameter of the Angular Contact Thrust Ball Bearings has been determined in such a way that the bearings have a certain clearance in the housing bore.



1: Double Direction Angular Contact Thrust Ball Bearings

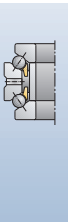

FAG Double Direction Angular Contact Thrust Ball Bearings

Bearing design

Bearing Design

The Double Direction Angular Contact Thrust Ball Bearings have a contact angle of 60° and are axially preloaded. This results in their high axial load carrying capacity and

rigidity. They are offered in the series 2344.. and 2347.... Bearings in series 2344.. are mounted on the small taper diameter side of the NN30 Cylindrical Roller Bearing, while bearings in series 2347.. are mounted on the large-end taper

side. Figures 2 and 3 show the interaction between series 2344../2347.. and the NN30 Double Row Cylindrical Roller Bearings.

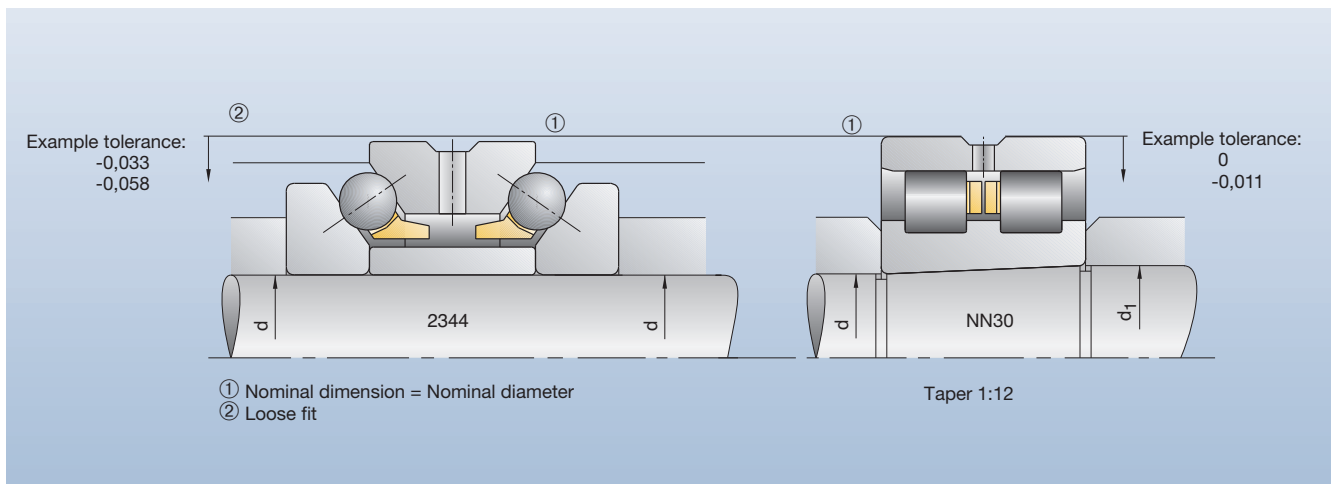

2: NN30...K with 2344 Double Direction Angular Contact Thrust Ball Bearing on the small taper diameter

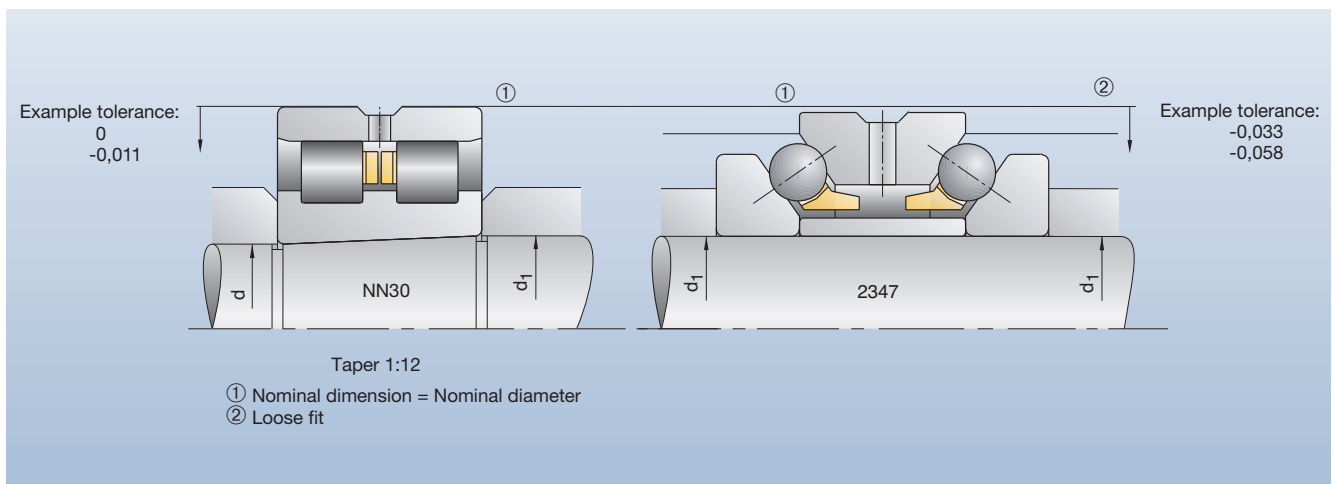

3: NN30...K Cylindrical Roller Bearing with 2347 Double Direction Angular Contact Thrust Ball Bearing on the large taper diameter

FAG Double Direction Angular Contact Thrust Ball Bearings

Lubrication

Lubrication

FAG Angular Contact Thrust Ball Bearings can be lubricated either with grease or oil. Their housing washers are designed with a lubricating groove and lubricating holes at the center. The lubricant supply between the two rows of balls utilizes the conveying effect of the bearing. Due to this high conveying effect, the bearings require a considerably greater amount of oil than is required for the adjacent Cylindrical Roller Bearings. The design should therefore ensure that the oil flow from the Angular Contact Thrust Ball Bearings does not reach the adjacent Cylindrical Roller Bearings.



4: Often used in this combination:

2344../2347.. Double Direction Angular Contact Thrust Ball Bearing with NN30.. Double Row Cylindrical Roller Bearing

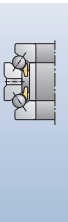

Bearing Code

FAG Double Direction Angular Contact Thrust Ball Bearing

2344 24-M-SP

Series designation

- 2344** For mounting at small end taper
2347 For mounting at large end taper

Bore Reference Number

- 06** $6 \cdot 5 = 30$ mm
10 $10 \cdot 5 = 50$ mm

Accuracy

- SP** Special Precision
UP Ultra Precision

Cage

- M** Brass cage

Bearing Marking

FAG Double Direction Angular Contact Thrust Ball Bearing

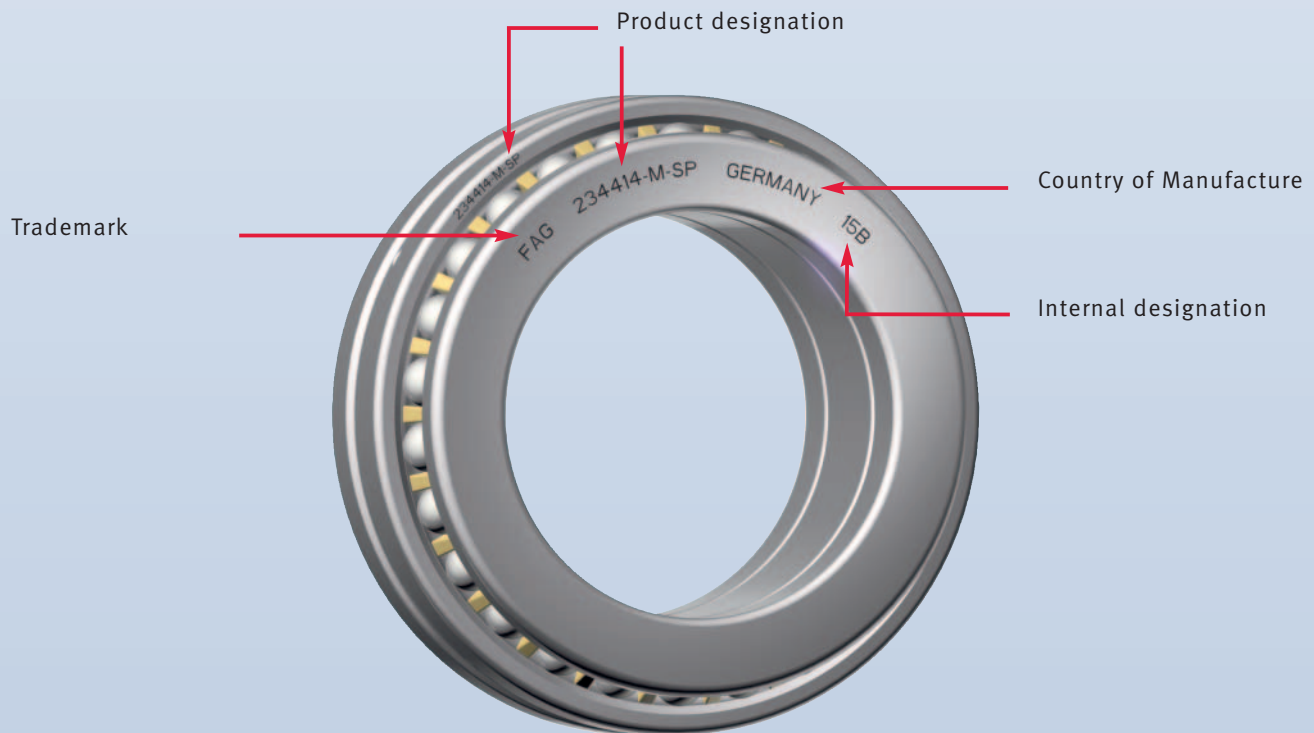

FAG Double Direction Angular Contact Thrust Ball Bearings

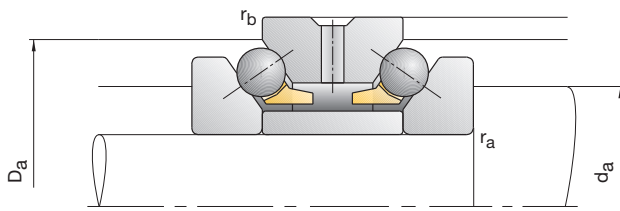

Bearing code	Dimensions						Abutment dimensions							
	d	D	H	r _{smin}	r _{1smin}	d _b	B _i	C	n _s	d _s	d _a h12	D _a H12	r _a max	r _b max
FAG	mm													
234406-M-SP	30	55	32	1,00	0,15	47,0	8,0	16	4,8	3,2	40,5	50,5	1,00	0,15
234706-M-SP	32	55	32	1,00	0,15	47,0	8,0	16	4,8	3,2	40,5	50,5	1,00	0,15
234407-M-SP	35	62	34	1,00	0,15	53,0	8,5	17	4,8	3,2	46,5	57,0	1,00	0,15
234707-M-SP	37	62	34	1,00	0,15	53,0	8,5	17	4,8	3,2	46,5	57,0	1,00	0,15
234408-M-SP	40	68	36	1,00	0,15	58,5	9,0	18	4,8	3,2	51,5	63,5	1,00	0,15
234708-M-SP	42	68	36	1,00	0,15	58,5	9,0	18	4,8	3,2	51,5	63,5	1,00	0,15
234409-M-SP	45	75	38	1,00	0,15	65,0	9,5	19	4,8	3,2	57,5	70,0	1,00	0,15
234709-M-SP	47	75	38	1,00	0,15	65,0	9,5	19	4,8	3,2	57,5	70,0	1,00	0,15
234410-M-SP	50	80	38	1,00	0,15	70,0	9,5	19	4,8	3,2	62,5	75,0	1,00	0,15
234710-M-SP	52	80	38	1,00	0,15	70,0	9,5	19	4,8	3,2	62,5	75,0	1,00	0,15
234411-M-SP	55	90	44	1,10	0,30	78,0	11,0	22	6,5	3,2	69,0	84,5	1,10	0,30
234711-M-SP	57	90	44	1,10	0,30	78,0	11,0	22	6,5	3,2	69,0	84,5	1,10	0,30
234412-M-SP	60	95	44	1,10	0,30	83,0	11,0	22	6,5	3,2	74,0	89,5	1,10	0,30
234712-M-SP	62	95	44	1,10	0,30	83,0	11,0	22	6,5	3,2	74,0	89,5	1,10	0,30
234413-M-SP	65	100	44	1,10	0,30	88,0	11,0	22	6,5	3,2	79,0	94,5	1,10	0,30
234713-M-SP	67	100	44	1,10	0,30	88,0	11,0	22	6,5	3,2	79,0	94,5	1,10	0,30
234414-M-SP	70	110	48	1,10	0,30	97,0	12,0	24	6,5	3,2	86,5	103,5	1,10	0,30
234714-M-SP	73	110	48	1,10	0,30	97,0	12,0	24	6,5	3,2	86,5	103,5	1,10	0,30

Designation examples:

Standard design
234410-M-SP

Standard design
234710-M-SP

2344, 2347

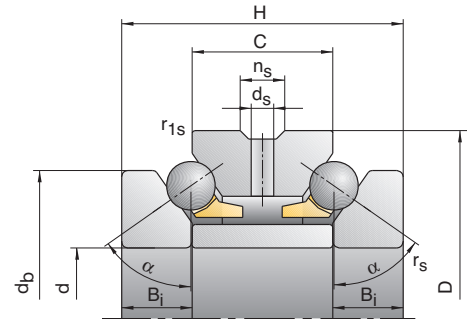

Load rating		Attainable speed		Preloading force	Unloading force	Axial rigidity	Weight	Bearing code
C _{dyn}	C _{0stat}	Grease	Oil minimal	F _v	K _{aE}	C _a		
kN		min ⁻¹		N		N/μm	kg	FAG
14,30	24,00	11 000	16 000	108	308	276	0,29	234406-M-SP
14,30	24,00	11 000	16 000	108	308	276	0,27	234706-M-SP
17,60	31,50	9 500	14 000	134	382	316	0,38	234407-M-SP
17,60	31,50	9 500	14 000	134	382	316	0,35	234707-M-SP
20,80	38,00	8 500	12 000	160	456	354	0,46	234408-M-SP
20,80	38,00	8 500	12 000	160	456	354	0,43	234708-M-SP
23,20	45,00	7 500	10 000	180	514	387	0,58	234409-M-SP
23,20	45,00	7 500	10 000	180	514	387	0,54	234709-M-SP
24,00	49,00	7 000	9 500	183	522	410	0,63	234410-M-SP
24,00	49,00	7 000	9 500	183	522	410	0,58	234710-M-SP
34,00	67,00	6 300	8 500	260	743	458	0,94	234411-M-SP
34,00	67,00	6 300	8 500	260	743	458	0,88	234711-M-SP
33,50	68,00	6 000	8 000	255	728	455	1,01	234412-M-SP
33,50	68,00	6 000	8 000	255	728	455	0,94	234712-M-SP
36,00	76,50	5 600	7 500	275	785	506	1,08	234413-M-SP
36,00	76,50	5 600	7 500	275	785	506	1,01	234713-M-SP
42,50	93,00	5 300	7 000	325	926	552	1,49	234414-M-SP
42,50	93,00	5 300	7 000	325	926	552	1,36	234714-M-SP



30
73

FAG Double Direction Angular Contact Thrust Ball Bearings

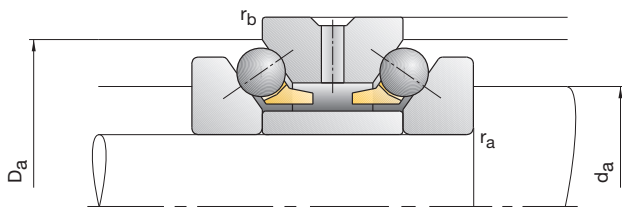

Bearing code	Dimensions						Abutment dimensions							
	d	D	H	r _{smin}	r _{1smin}	d _b	B _i	C	n _s	d _s	d _a h12	D _a H12	r _a max	r _b max
FAG	mm													
234415-M-SP	75	115	48	1,10	0,30	102,0	12,0	24	6,5	3,2	91,5	108,5	1,10	0,30
234715-M-SP	78	115	48	1,10	0,30	102,0	12,0	24	6,5	3,2	91,5	108,5	1,10	0,30
234416-M-SP	80	125	54	1,10	0,30	110,0	13,5	27	6,5	3,2	98,5	117,0	1,10	0,30
234716-M-SP	83	125	54	1,10	0,30	110,0	13,5	27	6,5	3,2	98,5	117,0	1,10	0,30
234417-M-SP	85	130	54	1,10	0,30	115,0	13,5	27	9,5	4,8	103,5	122,0	1,10	0,30
234717-M-SP	88	130	54	1,10	0,30	115,0	13,5	27	9,5	4,8	103,5	122,0	1,10	0,30
234418-M-SP	90	140	60	1,50	0,30	123,0	15,0	30	9,5	4,8	110,5	130,5	1,50	0,30
234718-M-SP	93	140	60	1,50	0,30	123,0	15,0	30	9,5	4,8	110,5	130,5	1,50	0,30
234419-M-SP	95	145	60	1,50	0,30	128,0	15,0	30	9,5	4,8	115,5	135,5	1,50	0,30
234719-M-SP	98	145	60	1,50	0,30	128,0	15,0	30	9,5	4,8	115,5	135,5	1,50	0,30
234420-M-SP	100	150	60	1,50	0,30	133,0	15,0	30	9,5	4,8	120,5	140,5	1,50	0,30
234720-M-SP	103	150	60	1,50	0,30	133,0	15,0	30	9,5	4,8	120,5	140,5	1,50	0,30
234421-M-SP	105	160	66	2,00	0,60	142,0	16,5	33	9,5	4,8	128,0	150,0	2,00	0,60
234721-M-SP	109	160	66	2,00	0,60	142,0	16,5	33	9,5	4,8	128,0	150,0	2,00	0,60
234422-M-SP	110	170	72	2,00	0,60	150,0	18,0	36	9,5	4,8	134,5	160,0	2,00	0,60
234722-M-SP	114	170	72	2,00	0,60	150,0	18,0	36	9,5	4,8	134,5	160,0	2,00	0,60
234424-M-SP	120	180	72	2,00	0,60	160,0	18,0	36	9,5	4,8	144,5	170,0	2,00	0,60
234724-M-SP	124	180	72	2,00	0,60	160,0	18,0	36	9,5	4,8	144,5	170,0	2,00	0,60

Designation examples:

Standard design
234420-M-SP

Standard design
234720-M-SP

2344, 2347

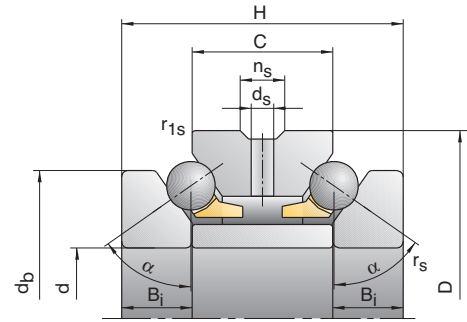

Load rating		Attainable speed		Preloading force	Unloading force	Axial rigidity	Weight	Bearing code
C _{dyn}	C _{0stat}	Grease	Oil minimal	F _v	K _{aE}	C _a		
kN		min ⁻¹		N		N/μm	kg	FAG
44,00	100,00	5 000	6 700	340	969	589	1,57	234415-M-SP
44,00	100,00	5 000	6 700	340	969	589	1,43	234715-M-SP
52,00	120,00	4 500	6 000	400	1 140	640	2,16	234416-M-SP
52,00	120,00	4 500	6 000	400	1 140	640	1,98	234716-M-SP
52,00	125,00	4 500	6 000	400	1 140	655	2,25	234417-M-SP
52,00	125,00	4 500	6 000	400	1 140	655	2,07	234717-M-SP
61,00	146,00	4 000	5 300	465	1 326	708	2,92	234418-M-SP
61,00	146,00	4 000	5 300	465	1 326	708	2,71	234718-M-SP
61,00	150,00	4 000	5 300	465	1 326	724	3,04	234419-M-SP
61,00	150,00	4 000	5 300	465	1 326	724	2,83	234719-M-SP
62,00	156,00	3 800	5 000	685	1 956	843	3,17	234420-M-SP
62,00	156,00	3 800	5 000	685	1 956	843	2,95	234720-M-SP
69,50	176,00	3 600	4 800	530	1 511	775	4,07	234421-M-SP
69,50	176,00	3 600	4 800	530	1 511	775	3,73	234721-M-SP
90,00	224,00	3 400	4 500	695	1 983	853	5,19	234422-M-SP
90,00	224,00	3 400	4 500	695	1 983	853	4,79	234722-M-SP
93,00	240,00	3 200	4 300	960	2 736	996	5,56	234424-M-SP
93,00	240,00	3 200	4 300	960	2 736	996	5,14	234724-M-SP



75
-
124

FAG Double Direction Angular Contact Thrust Ball Bearings

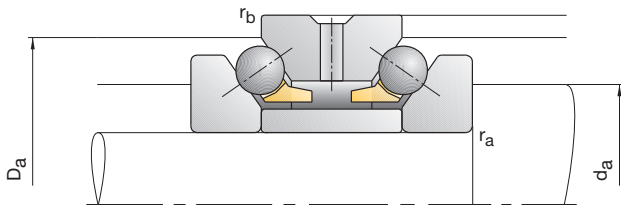

Bearing code	Dimensions						Abutment dimensions							
	d	D	H	r _{smin}	r _{1smin}	d _b	B _i	C	n _s	d _s	d _a h12	D _a H12	r _a max	r _b max
FAG	mm													
234426-M-SP	130	200	84	2,00	0,60	177,0	21,0	42	12,2	6,3	159,0	188,0	2,00	0,60
234726-M-SP	135	200	84	2,00	0,60	177,0	21,0	42	12,2	6,3	159,0	188,0	2,00	0,60
234428-M-SP	140	210	84	2,10	0,60	187,0	21,0	42	12,2	6,3	169,0	198,0	2,10	0,60
234728-M-SP	145	210	84	2,10	0,60	187,0	21,0	42	12,2	6,3	169,0	198,0	2,10	0,60
234430-M-SP	150	225	90	2,10	0,60	200,0	22,5	45	15,0	8,0	181,0	211,5	2,10	0,60
234730-M-SP	155	225	90	2,10	0,60	200,0	22,5	45	15,0	8,0	181,0	211,5	2,10	0,60
234432-M-SP	160	240	96	2,10	0,60	212,0	24,0	48	15,0	8,0	192,5	226,0	2,10	0,60
234732-M-SP	165	240	96	2,10	0,60	212,0	24,0	48	15,0	8,0	192,5	226,0	2,10	0,60
234434-M-SP	170	260	108	2,10	0,60	230,0	27,0	54	15,0	8,0	206,5	245,0	2,10	0,60
234734-M-SP	176	260	108	2,10	0,60	230,0	27,0	54	15,0	8,0	206,5	245,0	2,10	0,60
234436-M-SP	180	280	120	2,10	0,60	248,0	30,0	60	15,0	8,0	221,0	263,0	2,10	0,60
234736-M-SP	187	280	120	2,10	0,60	248,0	30,0	60	15,0	8,0	221,0	263,0	2,10	0,60
234438-M-SP	190	290	120	2,10	0,60	258,0	30,0	60	15,0	8,0	231,0	273,0	2,10	0,60
234738-M-SP	197	290	120	2,10	0,60	258,0	30,0	60	15,0	8,0	231,0	273,0	2,10	0,60
234440-M-SP	200	310	132	2,10	0,60	274,0	33,0	66	15,0	8,0	245,0	291,5	2,10	0,60
234740-M-SP	207	310	132	2,10	0,60	274,0	33,0	66	15,0	8,0	245,0	291,5	2,10	0,60
234444-M-SP	220	340	144	3,00	1,10	304,0	36,0	72	17,7	9,5	269,0	318,0	3,00	1,10
234744-M-SP	228	340	144	3,00	1,10	304,0	36,0	72	17,7	9,5	269,0	318,0	3,00	1,10

Designation examples:

Standard design
234432-M-SP

Standard design
234732-M-SP

2344, 2347

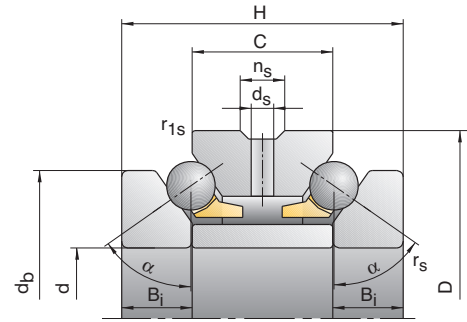

Load rating		Attainable speed		Preloading force	Unloading force	Axial rigidity	Weight	Bearing code
C _{dyn}	C _{0stat}	Grease	Oil minimal	F _v	K _{aE}	C _a		
kN		min ⁻¹		N		N/μm	kg	FAG
118,00	300,00	2800	3800	900	2570	978	8,28	234426-M-SP
118,00	300,00	2800	3800	900	2570	978	7,58	234726-M-SP
122,00	320,00	2600	3600	930	2649	1034	8,78	234428-M-SP
122,00	320,00	2600	3600	930	2649	1034	8,07	234728-M-SP
132,00	355,00	2600	3600	1320	3764	1183	10,80	234430-M-SP
132,00	355,00	2600	3600	1320	3764	1183	9,95	234730-M-SP
156,00	415,00	2400	3400	1180	3362	1149	12,90	234432-M-SP
156,00	415,00	2400	3400	1180	3362	1149	12,00	234732-M-SP
193,00	520,00	2200	3200	1847	5270	1362	17,70	234434-M-SP
193,00	520,00	2200	3200	1847	5270	1362	16,30	234734-M-SP
216,00	585,00	2000	3000	1660	4733	1315	23,40	234436-M-SP
216,00	585,00	2000	3000	1660	4733	1315	21,50	234736-M-SP
224,00	630,00	1900	2800	2110	6021	1495	24,70	234438-M-SP
224,00	630,00	1900	2800	2110	6021	1495	22,60	234738-M-SP
265,00	720,00	1800	2600	2000	5704	1449	31,50	234440-M-SP
265,00	720,00	1800	2600	2000	5704	1449	29,20	234740-M-SP
315,00	900,00	1600	2200	2400	6848	1629	41,70	234444-M-SP
315,00	900,00	1600	2200	2400	6848	1629	38,50	234744-M-SP



130
-
228

FAG Double Direction Angular Contact Thrust Ball Bearings

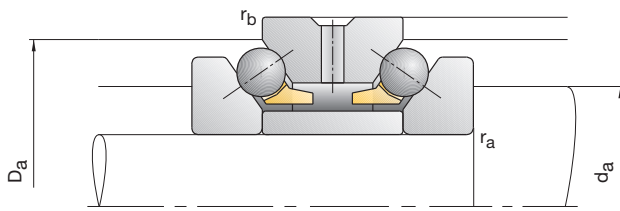

Bearing code	Dimensions						Abutment dimensions							
	d	D	H	r _{smin}	r _{1smin}	d _b	B _i	C	n _s	d _s	d _a h12	D _a H12	r _a max	r _b max
FAG	mm													
234448-M-SP	240	360	144	3,00	1,10	322,0	36,0	72	17,7	9,5	289,0	338,0	3,00	1,10
234748-M-SP	248	360	144	3,00	1,10	322,0	36,0	72	17,7	9,5	289,0	338,0	3,00	1,10
234452-M-SP	260	400	164	4,00	1,50	354,0	41,0	82	17,7	9,5	317,5	374,5	4,00	1,50
234752-M-SP	269	400	164	4,00	1,50	354,0	41,0	82	17,7	9,5	317,5	374,5	4,00	1,50
234456-M-SP	280	420	164	4,00	1,50	374,0	41,0	82	17,7	9,5	337,5	394,5	4,00	1,50
234756-M-SP	289	420	164	4,00	1,50	374,0	41,0	82	17,7	9,5	337,5	394,5	4,00	1,50
234460-M-SP	300	460	190	4,00	1,50	406,0	47,5	95	17,7	9,5	366,0	428,5	4,00	1,50
234760-M-SP	310	460	190	4,00	1,50	406,0	47,5	95	17,7	9,5	366,0	428,5	4,00	1,50
234464-M-SP	320	480	190	4,00	1,50	426,0	47,5	95	17,7	9,5	386,0	448,5	4,00	1,50
234764-M-SP	330	480	190	4,00	1,50	426,0	47,5	95	17,7	9,5	386,0	448,5	4,00	1,50
234468-M-SP	340	520	212	4,00	1,50	459,0	53,0	106	17,7	9,5	413,0	485,5	4,00	1,50
234768-M-SP	350	520	212	4,00	1,50	459,0	53,0	106	17,7	9,5	413,0	485,5	4,00	1,50
234472-M-SP	360	540	212	4,00	1,50	479,0	53,0	106	17,7	9,5	433,0	505,5	4,00	1,50
234772-M-SP	370	540	212	4,00	1,50	479,0	53,0	106	17,7	9,5	433,0	505,5	4,00	1,50
234476-M-SP	380	560	212	4,00	1,50	499,0	53,0	106	17,7	9,5	453,0	525,5	4,00	1,50
234776-M-SP	390	560	212	4,00	1,50	499,0	53,0	106	17,7	9,5	453,0	525,5	4,00	1,50
234480-M-SP	400	600	236	5,00	2,00	532,0	59,0	118	17,7	9,5	480,0	561,5	5,00	2,00
234780-M-SP	410	600	236	5,00	2,00	532,0	59,0	118	17,7	9,5	480,0	561,5	5,00	2,00

Designation examples:

Standard design
234464-M-SP

Standard design
234764-M-SP

2344, 2347

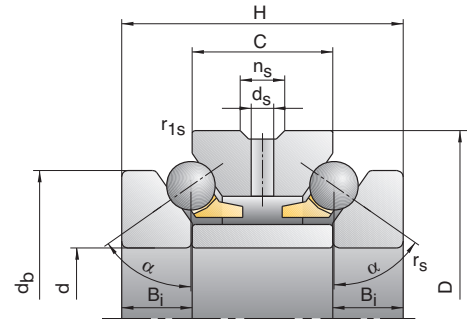

Load rating		Attainable speed		Preloading force	Unloading force	Axial rigidity	Weight	Bearing code
C _{dyn}	C _{0stat}	Grease	Oil minimal	F _v	K _{aE}	C _a		
kN		min ⁻¹		N		N/μm	kg	FAG
325,00	965,00	1500	2000	2500	7134	1729	43,80	234448-M-SP
325,00	965,00	1500	2000	2500	7134	1729	40,40	234748-M-SP
380,00	1180,00	1400	1900	2900	8257	1814	64,50	234452-M-SP
380,00	1180,00	1400	1900	2900	8257	1814	59,70	234752-M-SP
390,00	1270,00	1300	1800	3000	8542	1920	69,00	234456-M-SP
390,00	1270,00	1300	1800	3000	8542	1920	63,80	234756-M-SP
450,00	1530,00	1200	1700	3400	9682	2027	98,40	234460-M-SP
450,00	1530,00	1200	1700	3400	9682	2027	91,20	234760-M-SP
455,00	1630,00	1200	1700	3550	10109	2150	102,00	234464-M-SP
455,00	1630,00	1200	1700	3550	10109	2150	94,90	234764-M-SP
540,00	2000,00	1100	1600	4150	11820	2265	138,00	234468-M-SP
540,00	2000,00	1100	1600	4150	11820	2265	129,00	234768-M-SP
540,00	2040,00	1000	1500	4150	11820	2317	144,00	234472-M-SP
540,00	2040,00	1000	1500	4150	11820	2317	135,00	234772-M-SP
560,00	2200,00	1000	1500	4300	12248	2447	154,00	234476-M-SP
560,00	2200,00	1000	1500	4300	12248	2447	144,00	234776-M-SP
630,00	2550,00	900	1300	4900	13959	2539	198,00	234480-M-SP
630,00	2550,00	900	1300	4900	13959	2539	187,00	234780-M-SP



240
-
410

Tolerances for Super Precision Bearings

Definitions

Tolerances for Super Precision Bearings

The tolerances for super precision bearings are standardized according to DIN 620. Definitions for dimensions and accuracies are laid out in DIN ISO 1132.

To ensure the full utilization of the bearing performance capability and a high machining accuracy, the dimensions, form and running accuracies of FAG super precision bearings are manufactured to very close tolerances as standard.

The tolerances of form and position correspond to the accuracy standard

- P2 for all super precision spindle bearings and Floating Displacement bearings (FD)
Exception: Series B718... is standard P4.
- P4 for all Super Precision Cylindrical Roller Bearings and Double Direction Angular Contact Thrust Ball Bearings.
Super Precision Cylindrical Roller Bearings can be supplied in the higher precision class UP upon request.

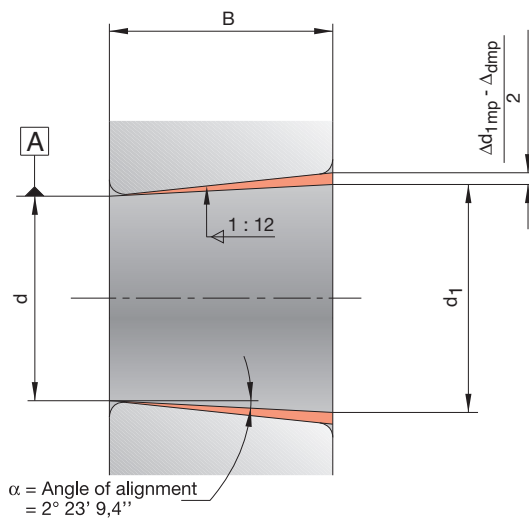

Tolerances for Super Precision Bearings

Bore diameter

Bore diameter

d = Nominal bore diameter
(tapered bore: smallest diameter)

d_1 = Nominal large-end diameter of tapered bores

Δ_{ds} = $d_s - d$
Deviation of single bore diameter from nominal dimension

Measurement principle

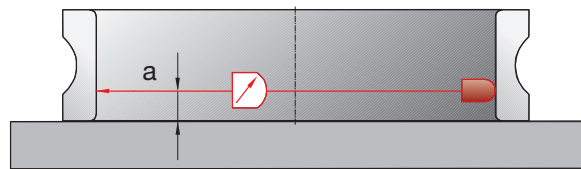

Δ_{dmp} = $d_{mp} - d$
Deviation of mean bore diameter from nominal dimension in one radial plane

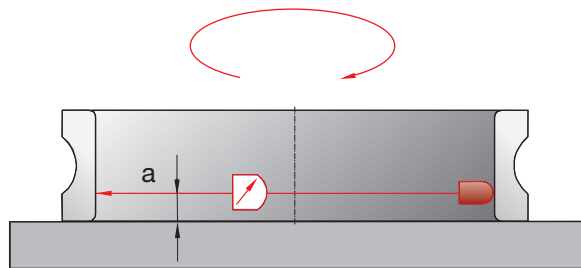

Δ_{d1mp} = $d_{1mp} - d_1$
Deviation of mean large-end diameter of tapered bore from nominal dimension

V_{dp} = $d_{psmax} - d_{psmin}$
Variation of single bore diameter in a radial plane
($V_{dp} \triangleq$ out-of-roundness to DIN 620);
($V_{dp/2} \triangleq$ roundness to DIN ISO 1132)
(Measurement principle \triangleq out-of-roundness)

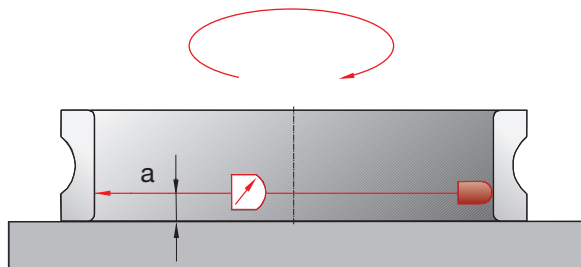

V_{dmp} = $d_{mpmax} - d_{mpmin}$
Variation of mean bore diameters of different radial planes

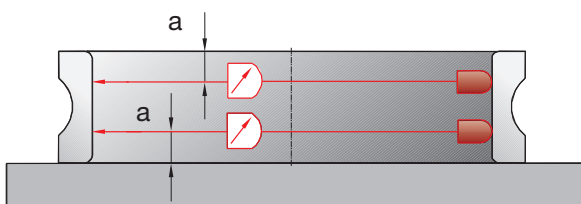

Tolerances for Super Precision Bearings

Outside diameter

Outside diameter

Measurement principle

D = Nominal outside diameter

$\Delta_{D_s} = D_s - D$
Deviation of single outside diameter from nominal dimension

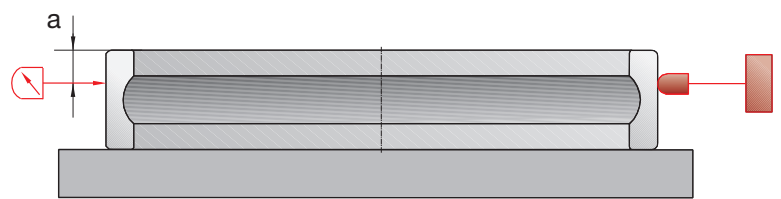

$\Delta_{D_{mp}} = D_{mp} - D$
Deviation of mean outside diameter from nominal dimension in one radial plane

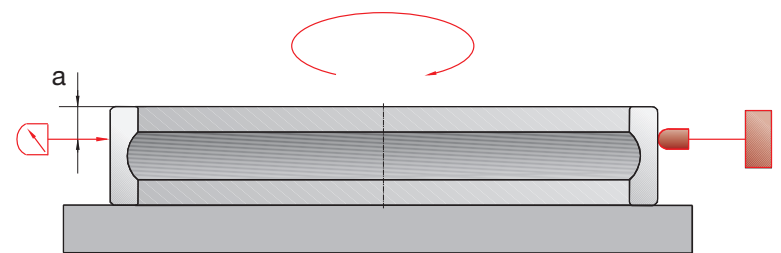

$V_{D_p} = D_{psmax} - D_{psmin}$
Variation of outside diameter in one radial plane
($V_{D_p} \triangleq$ out-of-roundness to DIN 620);
($V_{D_{p/2}} \triangleq$ roundness to DIN ISO 1132)
(Measurement principle \triangleq Out-of-roundness)

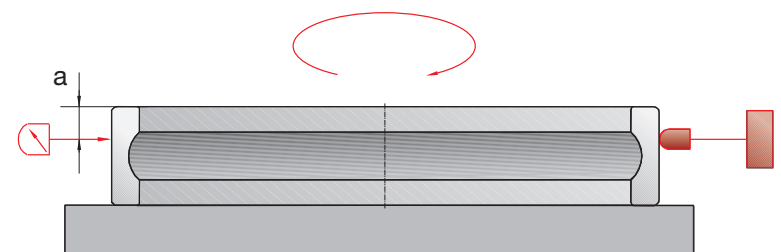

$V_{D_{mp}} = D_{mpmax} - D_{mpmin}$
Variation of mean outer diameters of different radial planes

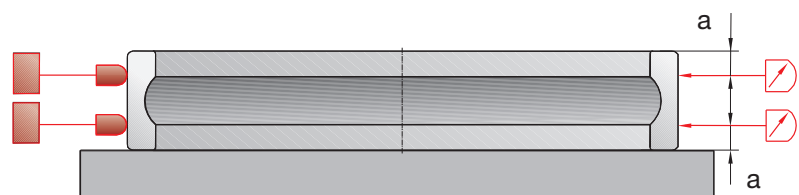

Tolerances for Super Precision Bearings

Width and height

Width and Height

Δ_{Bs} = $B_s - B$
 Deviation of single inner ring width
 from nominal dimension

Measurement principle

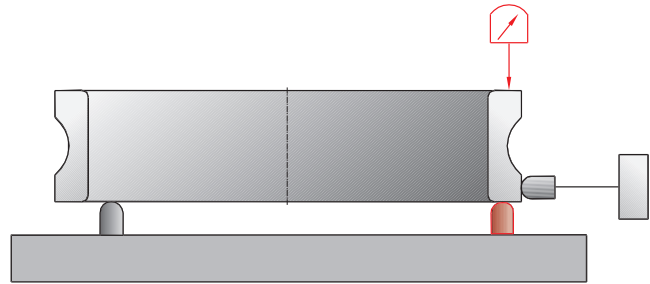

Δ_{Cs} = $C_s - C$
 Deviation of single outer ring width
 from nominal dimension

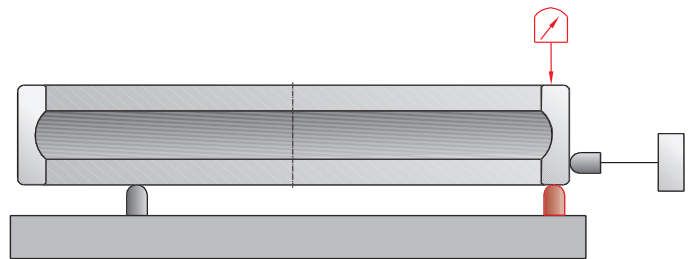

V_{Bs} = $B_{smax} - B_{smin}$
 Variation of inner ring width

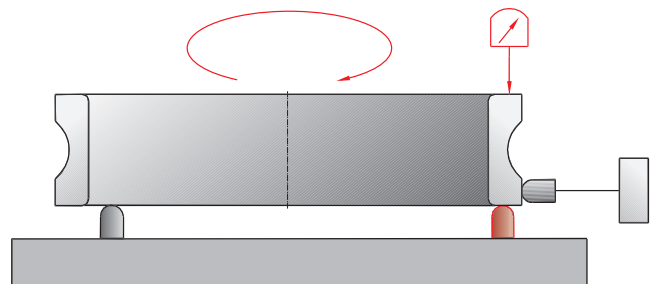

V_{Cs} = $C_{smax} - C_{smin}$
 Variation of outer ring width

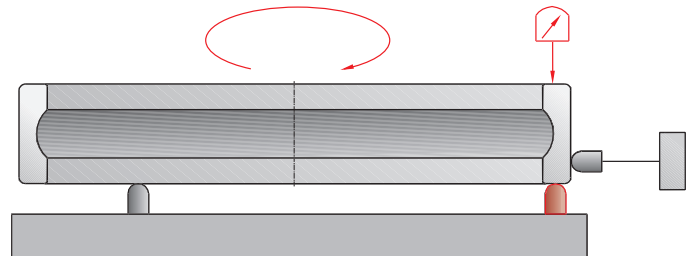

Δ_{Hs} = $H_s - H$
 Deviation of single total thrust
 bearing height from nominal
 dimension

Tolerances for Super Precision Bearings

Running accuracy

Running accuracy

K_{ia} = Radial runout of assembled bearing inner ring (radial runout)

Measurement principle

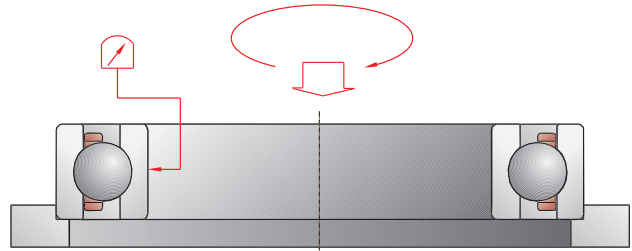

K_{ea} = Radial runout of assembled bearing outer ring (radial runout)

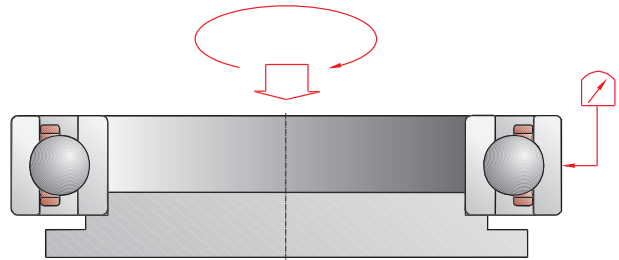

S_d = Side face runout of inner ring with reference to bore (axial runout)

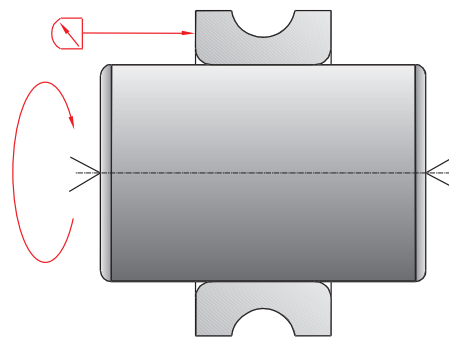

S_D = Variation in inclination of outside cylindrical surface to outer ring side face (axial runout)

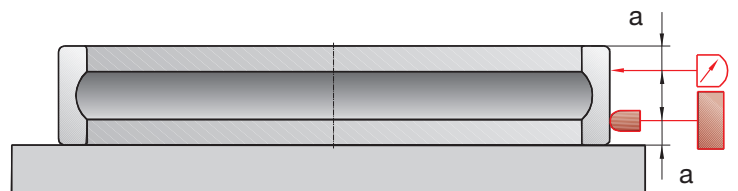

Tolerances for Super Precision Bearings

Running accuracy

S_{ia} = Side face runout of assembled bearing inner ring to inner ring raceway (axial runout)

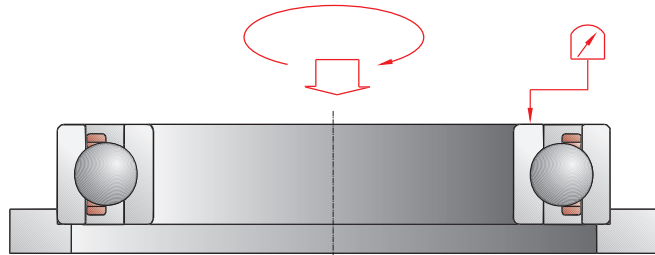

S_{ea} = Side face runout of assembled bearing outer ring to outer ring raceway (axial runout)

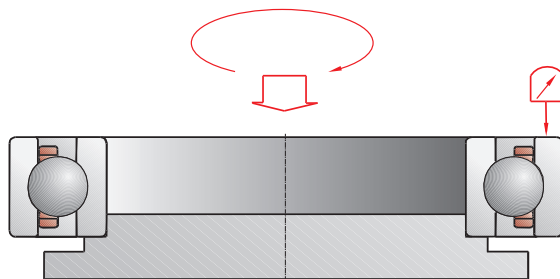

S_i = Wall thickness variation of thrust bearing shaft washers (axial runout of thrust bearings)

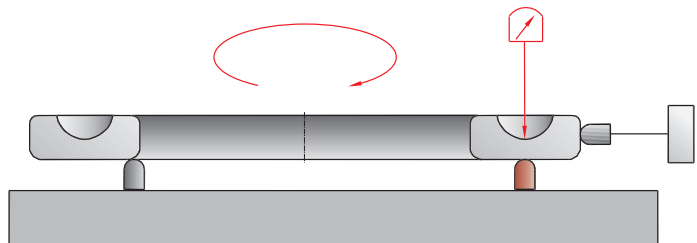

S_e = Wall thickness variation of thrust bearing housing washers (axial runout of thrust bearings)

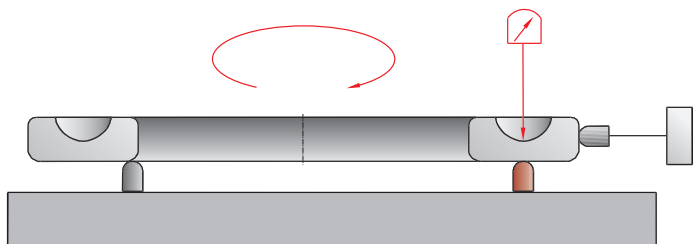

Tolerances for Single Row Angular Contact Ball Bearings (Spindle Bearings)

Tolerance class P4S

Inner ring		Dimensions in mm							
Nominal bearing bore diameter	over including	10	18	30	50	80	120	150	180

Tolerance class P4S		Tolerances in μm							
Bore deviation	$\Delta_{ds}, \Delta_{dmp}$	0	0	0	0	0	0	0	0
Variation (out of roundness) V_{dp}	Series 9 Series 0,2	-4	-4	-5	-6	-7	-8	-10	-10
Variation of mean diameter	V_{dmp}	2,5	2,5	2,5	3	3,5	4	5	5
		2	2	2	2,5	3	3	4	4
Width deviation	Δ_{Bs-mod}	1,5	1,5	1,5	2	2	2,5	3	3
		0	0	0	0	0	0	0	0
		-100	-100	-120	-120	-150	-200	-250	-250
Width variation	V_{Bs}	1,5	1,5	1,5	1,5	1,5	2,5	2,5	4
Radial runout	K_{ia}	1,5	1,5	2,5	2,5	2,5	2,5	2,5	3
Axial runout	S_d	1,5	1,5	1,5	1,5	1,5	2,5	2,5	4
Axial runout	S_{ia}	1,5	1,5	2,5	2,5	2,5	2,5	2,5	5

Outer ring		Dimensions in mm							
Nominal outer diameter	over including	10	18	30	50	80	120	150	180
		18	30	50	80	120	150	180	250

Tolerance class P4S		Tolerances in μm							
Outer diameter deviation	$\Delta_{Ds}, \Delta_{Dmp}$	0	0	0	0	0	0	0	0
Variation (out of roundness) ¹⁾ V_{Dp}	Series 9 Series 0,2	-4	-5	-6	-7	-8	-9	-10	-11
Variation of mean diameter	V_{Dmp}	2,5	2,5	3	3,5	4	5	5	6
		2	2	2,5	3	3	4	4	5
Width variation	V_{Cs}	1,5	1,5	2	2	2,5	3	3	4
Radial runout	K_{ea}	1,5	1,5	1,5	1,5	2,5	2,5	2,5	4
Variation of inclination	S_D	1,5	2,5	2,5	3	4	4	5	7
Axial runout	S_{ea}	1,5	2,5	2,5	4	5	5	5	7

Width deviation Δ_{Cs} is identical with Δ_{Bs} of the corresponding inner ring.

¹⁾ Valid for open bearings; the values apply before assembly for sealed bearings and DLR bearings

B719..C/E, B70, B72 HS719..C/E, HS70

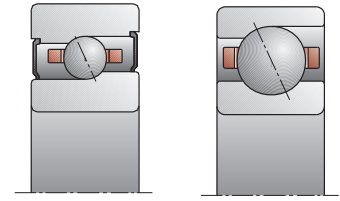

Dimensions in mm							Inner ring
180	250	315	400	500	630	over	Nominal bearing bore diameter
250	315	400	500	630	800	including	
Tolerances in μm							Tolerance class P4S
0	0	0	0	0	0		Bore deviation
-12	-15	-19	-23	-26	-32	$\Delta_{ds}, \Delta_{dmp}$	
6	8	10	12	13	16	Series 9	Variation (out of roundness)
5	6	8	10	10	13	Series 0,2	V_{dp}
4	5	6	8	8	10	V_{dmp}	Variation of mean diameter
0	0	0	0	0	0	Δ_{Bs-mod}	Width deviation
-300	-350	-400	-450	-500	-750		
5	6	7	8	10	12	V_{Bs}	Width variation
4	5	7	8	9	10	K_{ia}	Radial runout
5	6	7	8	10	12	S_d	Axial runout
5	7	9	11	13	15	S_{ia}	Axial runout

Dimensions in mm							Outer ring
250	315	400	500	630	800	over	Nominal outer diameter
315	400	500	630	800	1000	to	
Tolerances in μm							Tolerance class P4S
0	0	0	0	0	0		Outer diameter deviation
-13	-15	-18	-22	-26	-33	$\Delta_{Ds}, \Delta_{Dmp}$	
7	8	9	11	13	17	Series 9	Variation (out of roundness) ¹⁾
6	6	7	9	10	14	Series 0,2	V_{Dp}
4	5	6	7	8	11	V_{Dmp}	Variation of mean diameter
5	7	7	8	9	11	V_{Cs}	Width variation
7	8	9	11	13	15	K_{ea}	Radial runout
5	7	8	9	10	12	S_D	Variation of inclination
7	8	10	12	14	17	S_{ea}	Axial runout

Width deviation Δ_{Cs} is identical with Δ_{Bs} of the corresponding inner ring.

¹⁾ Valid for open bearings; the values apply before assembly for sealed bearings and DLR bearings

Tolerances for Single Row Angular Contact Ball Bearings (Spindle Bearings)

Tolerance class P4

Inner ring		Dimensions in mm						
Nominal bearing bore diameter	over	10	18	30	50	80	120	
	including	10	18	30	50	80	120	150

Tolerance class P4		Tolerances in μm						
Bore deviation		0	0	0	0	0	0	0
	$\Delta_{ds}, \Delta_{dmp}$	-4	-4	-5	-6	-7	-8	-10
Variation (out-of-roundness) V_{dp}	Series 8	2,5	2,5	2,5	3	3,5	4	5
Variation of mean diameter	V_{dmp}	1,5	1,5	1,5	2	2	2,5	3
Width deviation	Δ_{Bs-mod}	0	0	0	0	0	0	0
		-100	-100	-120	-120	-150	-200	-250
Width variation	V_{Bs}	2	2	2,5	3	4	4	5
Radial runout	K_{ia}	2,5	2,5	3	4	4	5	6
Axial runout	S_d	2,5	2,5	3	3	4	4	5
Axial runout	S_{ia}	3	3	4	4	5	5	6

Outer ring		Dimensions in mm						
Nominal outer diameter	over	10	18	30	50	80	120	150
	including	18	30	50	80	120	150	180

Tolerance class P4		Tolerances in μm						
Outer diameter deviation		0	0	0	0	0	0	0
	$\Delta_{Ds}, \Delta_{Dmp}$	-4	-5	-6	-7	-8	-9	-10
Variation (out-of-roundness) V_{Dp} ¹⁾	Series 8	2,5	2,5	3	3,5	4	5	5
Variation of mean diameter	V_{Dmp}	1,5	1,5	2	2	2,5	3	3
Width variation	V_{Cs}	2,5	2,5	2,5	3	4	5	5
Radial runout	K_{ea}	3	4	5	5	6	7	8
Variation of inclination	S_D	3	3	3	3	4	5	5
Axial runout	S_{ea}	4	4	4	5	6	7	8

Width deviation Δ_{Cs} is identical with Δ_{Bs} of the corresponding inner ring.

¹⁾ Valid for open bearings; the values apply before assembly for sealed bearings and DLR bearings

B718..C/E

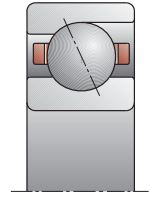

Dimensions in mm						Inner ring
150	180	250	315	400	over	Nominal bearing bore diameter
180	250	315	400	500	including	

Tolerances in μm						Tolerance class P4
0	0	0	0	0	$\Delta_{ds}, \Delta_{dmp}$	Bore deviation
-10	-12	-15	-19	-23	Series 8	Variation (out of roundness) V_{dp}
5	6	8	10	12	V_{dmp}	Variation of mean diameter
3	4	5	6	8		
0	0	0	0	0	Δ_{Bs-mod}	Width deviation
-250	-300	-350	-400	-450	V_{Bs}	Width variation
5	6	8	10	12	K_{ia}	Radial runout
6	8	9	10	12	S_d	Axial runout
5	7	8	10	12	S_{ia}	Axial runout
6	8	10	12	15		

Dimensions in mm						Outer ring
180	250	315	400	500	over	Nominal outer diameter
250	315	400	500	630	including	

Tolerances in μm						Tolerance class P4
0	0	0	0	0	$\Delta_{Ds}, \Delta_{Dmp}$	Outer diameter deviation
-11	-13	-15	-18	-22	Series 8	Variation (out-of-roundness) $V_{Dp}^{1)}$
6	7	8	9	11	V_{Dmp}	Variation of mean diameter
4	4	5	6	7		
7	7	8	9	11	V_{Cs}	Width variation
9	10	12	14	17	K_{ea}	Radial runout
7	7	9	10	12	S_D	Variation of inclination
10	10	13	15	18	S_{ea}	Axial runout

Width deviation Δ_{Cs} is identical with Δ_{Bs} of the corresponding inner ring.

¹⁾ Valid for open bearings; the values apply before assembly for sealed bearings and DLR bearings

Tolerances for Floating Displacement Bearings

Tolerance class P4S

Inner ring		Dimensions in mm						
Nominal bearing bore diameter	over	10	18	30	50	80	120	150
	including	18	30	50	80	120	150	180

Tolerance class P4S		Tolerances in μm						
Bore deviation	Δ_{ds}	0	0	0	0	0	0	0
		-4	-5	-6	-7	-8	-10	-10
Variation (out-of-roundness) V_{dp}	Series 0	2	2	2,5	3	3	4	4
Variation of mean diameter	V_{dmp}	1,5	1,5	2	2	2,5	3	3
Bore, tapered deviation	Δ_{dmp}	5	6	7	8	10	12	12
		0	0	0	0	0	0	0
Variation (out-of-roundness) V_{dp}	Series 0	2	2	2	2,5	3	4	4
Deviation	$\Delta_{d1mp} - \Delta_{dmp}$	2	2	3	3	4	4	4
		0	0	0	0	0	0	0
Width deviation	Δ_{Bs}	0	0	0	0	0	0	0
		-80	-120	-120	-150	-200	-250	-250
Width variation	V_{Bs}	1,5	1,5	1,5	1,5	2,5	2,5	4
Radial runout	K_{ia}	1,5	2,5	2,5	2,5	2,5	2,5	3
Axial runout	S_d	1,5	1,5	1,5	1,5	2,5	2,5	4

Outer ring		Dimensions in mm						
Nominal outer diameter	over	18	30	50	80	120	150	180
	including	30	50	80	120	150	180	250

Tolerance class P4S		Tolerances in μm						
Outer diameter deviation	Δ_{Ds}	0	0	0	0	0	0	0
		-5	-6	-7	-8	-9	-10	-11
Variation (out-of-roundness) $V_{Dp}^{1)}$	Series 0	2	2,5	3	3	4	4	5
Variation of mean diameter	V_{Dmp}	1,5	2	2	2,5	3	3	4
Width variation	V_{Cs}	1,5	1,5	1,5	2,5	2,5	2,5	4
Radial runout	K_{ea}	2,5	2,5	3	4	4	5	7
Variation of inclination	S_D	1,5	1,5	1,5	2,5	2,5	2,5	4
Axial runout	S_{ea}	2,5	2,5	4	5	5	5	7

Width deviation Δ_{Cs} is identical with Δ_{Bs} of the corresponding inner ring.

¹⁾ Valid for open bearings; the values apply before assembly for sealed bearings and DLR bearings

FD10

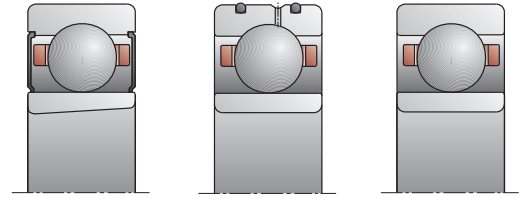

Dimensions in mm					Inner ring
180	250	315	400	over	Nominal bearing
250	315	400	500	including	bore diameter

Tolerances in μm					Tolerance class P4S
0	0	0	0		Bore deviation
-12	-15	-19	-23	Δ_{ds}	
5	6	8	10	Series 0	Variation (out-of-roundness) V_{dp}
4	5	6	8	V_{dmp}	Variation of mean diameter
14	18	23	28		Bore, tapered deviation
0	0	0	0	Δ_{dmp}	
5	6	7	8	Series 0	Variation (out-of-roundness) V_{dp}
5	7	9	11	$\Delta_{d1mp} - \Delta_{dmp}$	Deviation
0	0	0	0		
0	0	0	0	Δ_{Bs}	Width deviation
-300	-350	-400	-450		
5	6	7	8	V_{Bs}	Width variation
4	5	7	8	K_{ia}	Radial runout
5	6	7	8	S_d	Axial runout

Dimensions in mm					Outer ring
250	315	400	500	over	Nominal outer
315	400	500	630	including	diameter

Tolerances in μm					Tolerance class P4S
0	0	0	0		Outer diameter deviation
-13	-15	-18	-22	Δ_{Ds}	
6	6	7	9	Series 0	Variation (out-of-roundness) $V_{Dp}^{1)}$
4	5	6	7	V_{Dmp}	Variation of mean diameter
5	7	7	8	V_{Cs}	Width variation
7	8	9	11	K_{ea}	Radial runout
5	7	8	9	S_D	Variation of inclination
7	8	10	12	S_{ea}	Axial runout

Width deviation Δ_{Cs} is identical with Δ_{Bs} of the corresponding inner ring.

¹⁾ Valid for open bearings; the values apply before assembly for sealed bearings and DLR bearings

Radial clearance for Floating Displacement Bearings

Bearings with cylindrical and tapered bore			Dimensions in mm						
Nominal bearing bore diameter	over		10	18	23	30	40	50	65
	including		18	23	30	40	50	65	80

Bearing design		Internal clearance in μm							
Radial clearance	min.	4	4	6	8	12	18	24	
	max	10	10	14	16	22	30	38	

Radial clearance without measuring load
Rings are not interchangeable

FD10

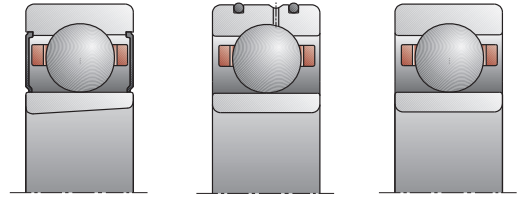

Bearings with cylindrical and tapered bore

Dimensions in mm

80	100	120	140	160	over	Nominal bearing bore diameter
100	120	140	160	180	including	

Bearing clearance in μm

Bearing design

30	38	46	55	65	min.	Radial clearance
45	56	64	73	85	max	

Radial clearance without measuring load

Rings are not interchangeable

Tolerances for Radial Bearings (Single Row Cylindrical Roller Bearings)

Tolerance class SP

Inner ring		Dimensions in mm						
Nominal bearing bore diameter	over	18	30	50	80	120	180	250
	including	30	50	80	120	180	250	315

Tolerance class SP		Tolerances in μm						
Bore, cylindrical deviation		0	0	0	0	0	0	0
	$\Delta_{ds}, \Delta_{dmp}$	-6	-8	-9	-10	-13	-15	-18
Variation (out-of-roundness)	V_{dp}	3	4	5	5	7	8	9
Variation of mean diameter	V_{dmp}	3	4	5	5	7	8	9
Bore, tapered deviation		10	12	15	20	25	30	35
	Δ_{dmp}	0	0	0	0	0	0	0
Variation (out-of-roundness)	V_{dp}	3	4	5	5	7	8	9
Deviation	$\Delta_{d1mp} - \Delta_{dmp}$	4	4	5	6	8	9	11
		0	0	0	0	0	0	0
Width deviation	Δ_{Bs}	0	0	0	0	0	0	0
		-120	-120	-150	-200	-250	-300	-350
Width variation	V_{Bs}	1,5	2	3	3	4	5	6
Radial runout	K_{ia}	3	4	4	5	6	8	9
Axial runout	S_d	3	3	4	4	5	6	7
Axial runout	S_{ia}	4	4	5	5	7	8	10

Outer ring		Dimensions in mm						
Nominal outer diameter	over	30	50	80	120	150	180	250
	including	50	80	120	150	180	250	315

Tolerance class SP		Tolerances in μm						
Outer diameter deviation		0	0	0	0	0	0	0
	$\Delta_{Ds}, \Delta_{Dmp}$	-7	-9	-10	-11	-13	-15	-18
Variation (out-of-roundness)	V_{Dp}	4	5	5	6	7	8	9
Variation of mean diameter	V_{Dmp}	4	5	5	6	7	8	9
Width variation	V_{Cs}	2,5	3	4	5	5	7	7
Radial runout	K_{ea}	5	5	6	7	8	10	11
Variation of inclination	S_D	4	4	5	5	5	7	8
Axial runout	S_{ea}	5	5	6	7	8	10	10

Width deviation Δ_{Cs} is identical with Δ_{Bs} of the corresponding inner ring.

N10, N19, HCN10

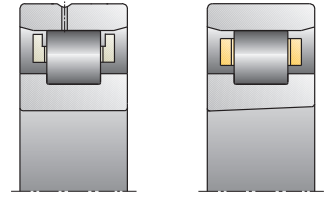

Inner ring					
Dimensions in mm					
315	400	500	630	over	
400	500	630	800	including	
Nominal bearing bore diameter					
Tolerance class SP					
Tolerances in μm					
0	0	0	0	$\Delta_{ds}, \Delta_{dmp}$	Bore, cylindrical deviation
-23	-27	-30	-40		
12	14	15	20	V_{dp}	Variation (out-of-roundness)
12	14	15	20	V_{dmp}	Variation of mean diameter
Bore, tapered deviation					
40	45	50	65	Δ_{dmp}	Variation
0	0	0	0		
12	14	15	20	V_{dp}	Variation
12	14	15	18	$\Delta_{d1mp} - \Delta_{dmp}$	Deviation
0	0	0	0	Δ_{Bs}	Width deviation
0	0	0	0		
-400	-450	-500	-750	V_{Bs}	Width variation
7	8	10	12		
10	12	14	17	K_{ia}	Radial runout
9	11	13	15	S_d	Axial runout
12	15	18	21	S_{ia}	Axial runout

Outer ring						
Dimensions in mm						
315	400	500	630	800	over	
400	500	630	800	1000	to	
Nominal outer diameter						
Tolerance class SP						
Tolerances in μm						
0	0	0	0	0	$\Delta_{Ds}, \Delta_{Dmp}$	Outer diameter deviation
-20	-23	-28	-35	-40		
10	12	14	18	20	V_{Dp}	Variation (out-of-roundness)
10	12	14	18	20	V_{Dmp}	Variation of mean diameter
8	9	11	13	15	V_{Cs}	Width variation
13	15	17	20	23	K_{ea}	Radial runout
10	11	13	15	17	S_D	Variation of inclination
13	15	18	22	26	S_{ea}	Axial runout

Width deviation Δ_{Cs} is identical with Δ_{Bs} of the corresponding inner ring.

Tolerances for Radial Bearings (Double Row Cylindrical Roller Bearings)

Tolerance class SP

Inner ring		Dimensions in mm						
Nominal bearing bore diameter	over	18	30	50	80	120	180	250
	including	30	50	80	120	180	250	315

Tolerance class SP		Tolerances in μm						
Bore, cylindrical deviation		0	0	0	0	0	0	0
	$\Delta_{ds}, \Delta_{dmp}$	-6	-8	-9	-10	-13	-15	-18
Variation (out-of-roundness)	V_{dp}	3	4	5	5	7	8	9
Variation of mean diameter	V_{dmp}	3	4	5	5	7	8	9
Bore, tapered deviation		10	12	15	20	25	30	35
	Δ_{dmp}	0	0	0	0	0	0	0
Variation (out-of-roundness)	V_{dp}	3	4	5	5	7	8	9
Deviation	$\Delta_{d1mp} - \Delta_{dmp}$	4	4	5	6	8	9	11
		0	0	0	0	0	0	0
Width deviation	Δ_{Bs}	0	0	0	0	0	0	0
		-120	-120	-150	-200	-250	-300	-350
Width variation	V_{Bs}	2,5	3	4	4	5	6	8
Radial runout	K_{ia}	3	4	4	5	6	8	8
Axial runout	S_d	4	4	5	5	6	7	8
Axial runout	S_{ia}	4	4	5	5	7	8	10

Outer ring		Dimensions in mm						
Nominal outer diameter	over	30	50	80	120	150	180	250
	including	50	80	120	150	180	250	315

Tolerance class SP		Tolerances in μm						
Outer diameter deviation		0	0	0	0	0	0	0
	$\Delta_{Ds}, \Delta_{Dmp}$	-7	-9	-10	-11	-13	-15	-18
Variation (out-of-roundness)	V_{Dp}	4	5	5	6	7	8	9
Variation of mean diameter	V_{Dmp}	4	5	5	6	7	8	9
Width variation	V_{Cs}	2,5	3	4	5	5	7	7
Radial runout	K_{ea}	5	5	6	7	8	10	11
Variation of inclination	S_D	4	4	5	5	5	7	8
Axial runout	S_{ea}	5	5	6	7	8	10	10

Width deviation Δ_{Cs} is identical with Δ_{Bs} of the corresponding inner ring.

NN30, NNU49

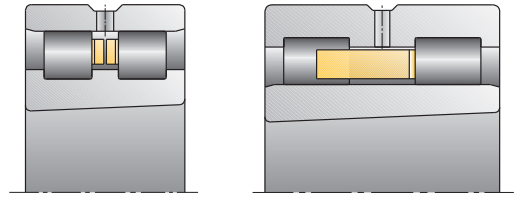

Dimensions in mm					Inner ring	
315	400	500	630		over	Nominal bearing
400	500	630	800		including	bore diameter
Tolerances in μm					Tolerance class SP	
0	0	0	0			Bore, cylindrical
-23	-27	-30	-40	$\Delta_{ds}, \Delta_{dmp}$		deviation
12	14	15	20	V_{dp}		Variation (out-of-roundness)
12	14	15	20	V_{dmp}		Variation of mean diameter
40	45	50	65			Bore, tapered
0	0	0	0	Δ_{dmp}		deviation
12	14	15	20	V_{dp}		Variation (out-of-roundness)
12	14	15	18	$\Delta_{d1mp} - \Delta_{dmp}$		Deviation
0	0	0	0			
0	0	0	0	Δ_{Bs}		Width deviation
-400	-450	-500	-750			
10	12	14	17	V_{Bs}		Width variation
10	10	12	15	K_{ia}		Radial runout
10	12	14	17	S_d		Axial runout
12	15	18	21	S_{ia}		Axial runout

Dimensions in mm						Outer ring	
315	400	500	630	800	over	Nominal outer	
400	500	630	800	1000	to	diameter	
Tolerances in μm						Tolerance class SP	
0	0	0	0	0		Outer diameter	
-20	-23	-28	-35	-40	$\Delta_{Ds}, \Delta_{Dmp}$	deviation	
10	12	14	18	20	V_{Dp}	Variation (out-of-roundness)	
10	12	14	18	20	V_{Dmp}	Variation of mean diameter	
8	9	11	13	15	V_{Cs}	Width variation	
13	15	17	20	23	K_{ea}	Radial runout	
10	11	13	15	17	S_D	Variation of inclination	
13	15	18	22	26	S_{ea}	Axial runout	

Width deviation Δ_{Cs} is identical with Δ_{Bs} of the corresponding inner ring.

Tolerances for Radial Bearings (Single and Double Row Cylindrical Roller Bearings)

Tolerance class UP

Inner ring		Dimensions in mm						
Nominal bearing bore diameter	over	18	30	50	80	120	180	250
	including	30	50	80	120	180	250	315

Tolerance class UP		Tolerances in μm						
Bore, cylindrical deviation		0	0	0	0	0	0	0
	$\Delta_{ds}, \Delta_{dmp}$	-5	-6	-7	-8	-10	-12	-15
	Variation (out-of-roundness)	V_{dp}	2,5	3	3,5	4	5	6
Variation of mean diameter	V_{dmp}	2,5	3	3,5	4	5	6	8
Bore, tapered deviation		6	7	8	10	12	14	15
	Δ_{dmp}	0	0	0	0	0	0	0
	Variation (out-of-roundness)	V_{dp}	2,5	3	3,5	4	5	6
Deviation	$\Delta_{d1mp} - \Delta_{dmp}$	2	3	3	4	4	5	6
		0	0	0	0	0	0	0
Width deviation	Δ_{Bs}	0	0	0	0	0	0	0
		-25	-30	-40	-50	-60	-75	-100
Width variation	V_{Bs}	1,5	2	2,5	3	4	5	5
Radial runout	K_{ia}	1,5	2	2	3	3	4	4
Axial runout	S_d	3	3	4	4	5	6	6
Axial runout	S_{ia}	3	3	3	4	6	7	8

Outer ring		Dimensions in mm						
Nominal outer diameter	over	30	50	80	120	150	180	250
	including	50	80	120	150	180	250	315

Tolerance class UP		Tolerances in μm						
Outer diameter deviation		0	0	0	0	0	0	0
	$\Delta_{Ds}, \Delta_{Dmp}$	-5	-6	-7	-8	-9	-10	-12
	Variation (out-of-roundness)	V_{Dp}	3	3	4	4	5	5
Variation of mean diameter	V_{Dmp}	3	3	4	4	5	5	6
Width variation	V_{Cs}	1,5	2	3	4	4	5	5
Radial runout	K_{ea}	3	3	3	4	4	5	6
Variation of inclination	S_D	2	2	3	3	3	4	4
Axial runout	S_{ea}	3	4	5	5	5	7	7

Width deviation Δ_{Cs} is identical with Δ_{Bs} of the corresponding inner ring.

N10, N19, HCN10 NN30, NNU49

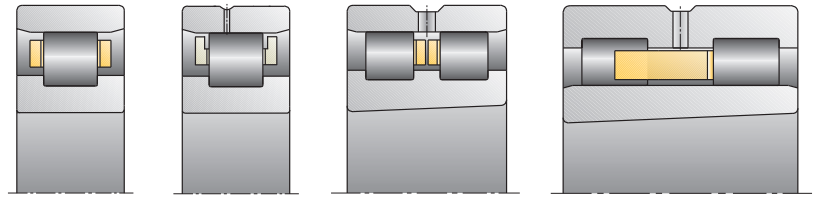

					Inner ring	
Dimensions in mm					over	Nominal bearing
315	400	500	630		including	bore diameter
400	500	630	800			

					Tolerance class UP	
Tolerances in μm						
0	0	0	0		$\Delta_{ds}, \Delta_{dmp}$	Bore, cylindrical deviation
-19	-23	-26	-34		V_{dp}	Variation (out-of-roundness)
10	12	13	17		V_{dmp}	Variation of mean diameter
10	12	13	17			
17	19	20	22			Bore, tapered deviation
0	0	0	0		Δ_{dmp}	deviation
10	12	13	17		V_{dp}	Variation
6	7	8	9		$\Delta_{d1mp} - \Delta_{dmp}$	Deviation
0	0	0	0			
0	0	0	0		Δ_{Bs}	Width deviation
-100	-100	-125	-125			
6	7	8	11		V_{Bs}	Width variation
5	5	6	7		K_{ia}	Radial runout
7	8	9	11		S_d	Axial runout
9	10	12	18		S_{ia}	Axial runout

						Outer ring	
Dimensions in mm						over	Nominal outer
315	400	500	630	800		to	diameter
400	500	630	800	1000			

						Tolerance class UP	
Tolerances in μm							
0	0	0	0	0		$\Delta_{Ds}, \Delta_{Dmp}$	Outer diameter deviation
-14	-17	-20	-25	-30		V_{Dp}	Variation (out-of-roundness)
7	9	10	13	15		V_{Dmp}	Variation of mean diameter
7	9	10	13	15			
6	7	8	11	12		V_{Cs}	Width variation
7	8	9	11	12		K_{ea}	Radial runout
5	5	6	7	10		S_D	Variation of inclination
8	10	12	14	17		S_{ea}	Axial runout

Width deviation Δ_{Cs} is identical with Δ_{Bs} of the corresponding inner ring.

Tolerances

Radial clearance of Cylindrical Roller Bearings (Single and Double Row)

Bearings with cylindrical bore		Dimensions in mm										
Nominal bearing bore diameter	over	24	30	40	50	65	80	100	120	140	160	180
	including	30	40	50	65	80	100	120	140	160	180	200

Bearing design		Internal clearance in μm										
Clearance group C1 ^{*)}	min.	5	5	5	5	10	10	10	10	10	10	15
	max	15	15	18	20	25	30	30	35	35	40	45
Clearance group C2 ^{**)}	min.	0	5	5	10	10	15	15	15	20	25	35
	max	25	30	35	40	45	50	55	60	70	75	90
Clearance group CN ^{**)}	min.	20	25	30	40	40	50	50	60	70	75	90
	max	45	50	60	70	75	85	90	105	120	125	145
Clearance group C3 ^{**)}	min.	35	45	50	60	65	75	85	100	115	120	140
	max	60	70	80	90	100	110	125	145	165	170	195

^{*)} Bearings of tolerance classes SP and UP feature a C1 radial clearance as standard, rings are not interchangeable (NA)

^{**)} Radial internal clearance groups C2–C3 can be ordered for SP and UP accuracy by means of suffixes, rings are interchangeable Radial clearance without measuring load

Bearings with tapered bore		Dimensions in mm										
Nominal bearing bore diameter	over	24	30	40	50	65	80	100	120	140	160	180
	including	30	40	50	65	80	100	120	140	160	180	200

Bearing design		Internal clearance in μm										
Clearance group C1 ^{*)}	min.	15	15	17	20	25	35	40	45	50	55	60
	max	25	25	30	35	40	55	60	70	75	85	90
Clearance group C2 ^{**)}	min.	20	20	25	30	35	40	50	55	60	75	85
	max	45	45	55	60	70	75	90	100	110	125	140
Clearance group CN ^{**)}	min.	35	40	45	50	60	70	90	100	110	125	140
	max	60	65	75	80	95	105	130	145	160	175	195
Clearance group C3 ^{**)}	min.	45	55	60	70	85	95	115	130	145	160	180
	max	70	80	90	100	120	130	155	175	195	210	235

^{*)} Bearings of tolerance classes SP and UP feature a C1 radial clearance as standard, rings are not interchangeable (NA)

^{**)} Radial internal clearance groups C2–C3 can be ordered for SP and UP accuracy by means of suffixes, rings are interchangeable Radial clearance without measuring load

N10, N19, HCN10 NN30, NNU 49

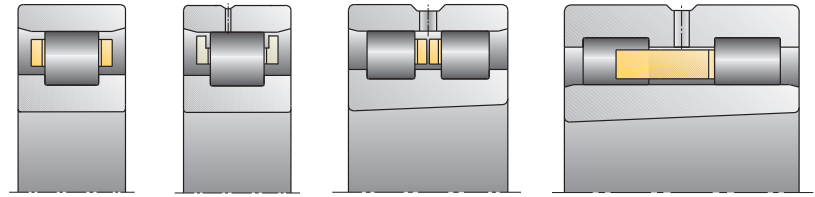

Bearings with cylindrical bore

Dimensions in mm

200	225	250	280	315	355	400	450	500	560	630	over	Nominal bearing
225	250	280	315	355	400	450	500	560	630	710	including	bore diameter

Bearing clearance in μm

Bearing design

15	15	20	20	20	25	25	25	25	30	30	min.	Clearance group C1 ^{*)}
50	50	55	60	65	75	85	95	100	110	130	max	

45	45	55	55	65	100	110	110	120	140	145	min.	Clearance group C2 ^{**)}
105	110	125	130	145	190	210	220	240	260	285	max	

105	110	125	130	145	190	210	220	240	260	285	min.	Clearance group CN ^{**)}
165	175	195	205	225	280	310	330	360	380	425	max	

160	170	190	200	225	280	310	330	360	380	425	min.	Clearance group C3 ^{**)}
220	235	260	275	305	370	410	440	480	500	565	max	

^{*)} Bearings of tolerance classes SP and UP feature a C1 radial clearance as standard, rings are not interchangeable (NA)

^{**)} Radial internal clearance groups C2–C3 can be ordered for SP and UP accuracy by means of suffixes, rings are interchangeable

Radial clearance without measuring load

Bearings with tapered bore

Dimensions in mm

200	225	250	280	315	355	400	450	500	560	630	over	Nominal bearing
225	250	280	315	355	400	450	500	560	630	710	including	bore diameter

Bearing clearance in μm

Bearing design

60	65	75	80	90	100	110	120	130	140	160	min.	Clearance group C1 ^{*)}
95	100	110	120	135	150	170	190	210	230	260	max	

95	105	115	130	145	165	185	205	230	260	295	min.	Clearance group C2 ^{**)}
155	170	185	205	225	255	285	315	350	380	435	max	

155	170	185	205	225	255	285	315	350	380	435	min.	Clearance group CN ^{**)}
215	235	255	280	305	345	385	425	470	500	575	max	

200	220	240	265	290	330	370	410	455	500	565	min.	Clearance group C3 ^{**)}
260	285	310	340	370	420	470	520	575	620	705	max	

^{*)} Bearings of tolerance classes SP and UP feature a C1 radial clearance as standard, rings are not interchangeable (NA)

^{**)} Radial internal clearance groups C2–C3 can be ordered for SP and UP accuracy by means of suffixes, rings are interchangeable

Radial clearance without measuring load

Tolerances for Double Direction Angular Contact Thrust Ball Bearings

Tolerance classes SP and UP

Shaft washer		Dimensions in mm						
Nominal bearing bore diameter	over including	18 30	30 50	50 80	80 120	120 150	150 180	180 250

Tolerance class SP		Tolerances in μm						
Bore deviation	Δ_{dmp}	0	0	0	0	0	0	0
Variation (out-of-roundness)	V_{dp}	-8	-10	-12	-15	-18	-18	-22
Wall thickness variation	S_i	6	8	9	11	14	14	17
Height deviation	Δ_{Hs}	3	3	4	4	5	5	5
		50	75	100	125	150	150	175
		-150	-200	-250	-300	-350	-350	-400

Tolerance class UP		Tolerances in μm						
Bore deviation	Δ_{dmp}	0	0	0	0	0	0	0
Variation (out-of-roundness)	V_{dp}	-6	-8	-9	-10	-13	-13	-15
Wall thickness variation	S_i	5	6	7	8	10	10	12
Height deviation	Δ_{Hs}	1,5	1,5	2	2	3	3	3
		50	75	100	125	150	150	175
		-150	-200	-250	-300	-350	-350	-400

Housing washer		Dimensions in mm						
Nominal outer diameter	over including	30 50	50 80	80 120	120 150	150 180	180 250	250 315

Tolerance class SP		Tolerances in μm						
Outer diameter deviation	Δ_{Dmp}	-20	-24	-28	-33	-33	-37	-41
Variation (out-of-roundness)	V_{Dp}	-36	-43	-50	-58	-58	-66	-73
Width deviation	Δ_{Cs}	5	6	8	9	9	10	12
Wall thickness variation	S_e	-120	-120	-125	-125	-125	-125	-150
		3	4	4	5	5	5	7

Tolerance class UP		Tolerances in μm						
Outer diameter deviation	Δ_{Dmp}	-20	-24	-28	-33	-33	-37	-41
Variation (out-of-roundness)	V_{Dp}	-36	-43	-50	-58	-58	-66	-73
Width deviation	Δ_{Cs}	5	6	8	9	9	10	12
Wall thickness variation	S_e	-120	-120	-125	-125	-125	-125	-150
		1,5	2	2	3	3	3	4

2344, 2347

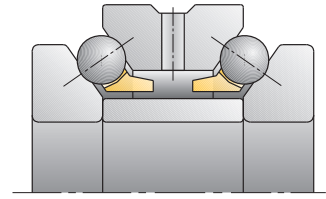

Dimensions in mm				Shaft washer	
250	315	400		over	Nominal bearing
315	400	500		including	bore diameter

Tolerances in μm				Tolerance class SP	
0	0	0			Bore
-25	-30	-35		Δ_{dmp}	deviation
19	22	26		V_{dp}	Variation (out-of-roundness)
7	7	9		S_{i}	Wall thickness variation
200	250	300		Δ_{Hs}	Height deviation
-450	-600	-750			

Tolerances in μm				Tolerance class UP	
0	0	0			Bore
-18	-23	-27		Δ_{dmp}	deviation
14	18	20		V_{dp}	Variation (out-of-roundness)
4	4	5		S_{i}	Wall thickness variation
200	250	300		Δ_{Hs}	Height deviation
-450	-600	-750			

Dimensions in mm				Housing washer	
315	400	500	630	over	Nominal outer diameter
400	500	630	800	including	

Tolerances in μm				Tolerance class SP	
-46	-50	-55	-60		Outer diameter
-82	-90	-99	-110		deviation
13	15	16	18	V_{Dp}	Variation (out-of-roundness)
-150	-200	-200	-250	Δ_{Cs}	Width deviation
7	9	11	13	S_{e}	Wall thickness variation

Tolerances in μm				Tolerance class UP	
-46	-50	-55	-55		Outer diameter
-82	-90	-99	-99		deviation
13	15	16	18	V_{Dp}	Variation (out-of-roundness)
-150	-200	-200	-250	Δ_{Cs}	Width deviation
4	5	6	7	S_{e}	Wall thickness variation

Corner dimensions

Limits for corner dimensions

Symbols:

- r_{smin} , r_{1smin} Symbol for the minimum corner dimensions in radial and axial direction
- r_{smaxr} , r_{1smaxr} Symbol for the maximum corner dimensions in radial direction
- r_{smaxa} , r_{1smaxa} Symbol for the maximum corner dimensions in axial direction
- Measurement distance "a" Start of bore diameter and/or outer diameter tolerances test area

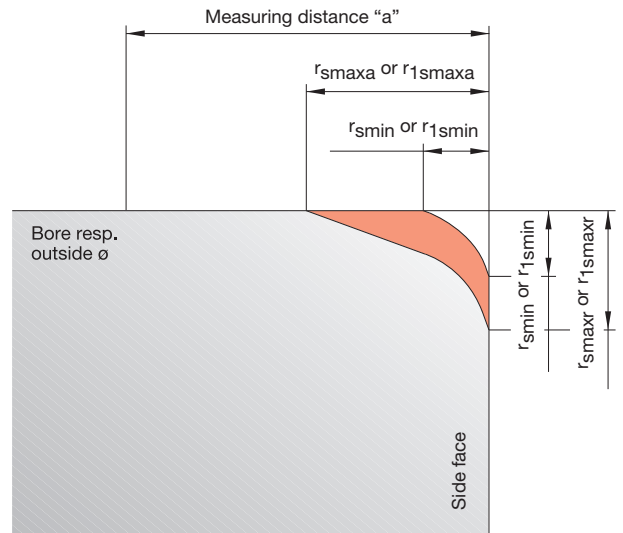

Chamfer dimension of Radial Bearings, cylindrical bore		Dimensions in mm																	
r_{smin} , r_{1smin}		0,1	0,15	0,2	0,3	0,3	0,3	0,6	0,6	0,6	1	1	1	1,1	1,1	1,1	1,5	1,5	
Nominal bearing	over					40	120	40	250	50	400	400	120	400	500	120	400	120	
bore diameter "d" including		25	25	40	40	120	250	40	250	400	50	400	500	120	400	500	120	400	

r_{smaxr} , r_{1smaxr}	radial	0,2	0,3	0,5	0,6	0,8	1	1	1,3	1,5	1,5	1,9	2,5	2	2,5	2,7	2,3	3
r_{smaxa} , r_{1smaxa}	axial	0,4	0,6	0,8	1	1	1,7	2	2	2,6	3	3	3,5	3,5	4	4,5	4	5
Measuring distance "a"		0,9	1,1	1,3	1,5	1,5	2,2	2,5	2,5	3,1	3,6	3,6	4,2	4,2	4,8	5,4	4,8	6

Corner dimensions of Radial Bearings, tapered bore		Dimensions in mm																	
r_{smin} , r_{1smin}		0,05	0,1	0,1	0,15	0,15	0,2	0,25	0,3	0,35	0,4	0,45	0,5	0,5	0,55	0,6	0,6	0,7	
Nominal bearing	over					40	120	40	250	50	400	400	120	400	500	120	400	120	
bore diameter "d" including		25	25	40	40	120	250	40	250	400	50	400	500	120	400	500	120	400	

r_{smaxr} , r_{1smaxr}	radial	0,15	0,3	0,3	0,45	0,45	0,6	0,75	0,9	1,05	1,2	1,35	1,5	1,5	1,65	1,8	1,8	2,1
r_{smaxa} , r_{1smaxa}	axial	0,25	0,5	0,5	0,75	0,75	1	1,25	1,5	1,75	2	2,25	2,5	2,5	2,75	3	3	3,5
Measuring distance "a"		0,8	1	1	1,3	1,3	1,5	1,8	2	2,3	2,5	2,8	3	3	3,3	3,5	3,5	4,2

Corner Dimension of Axial Bearings		Dimensions in mm																	
r_{smin} , r_{1smin}		0,1	0,15	0,2		0,3	0,6		1	1,1	1,5	2	2,1	3	4	5	6	7,5	
Nominal bearing	over					120			500										
bore diameter "d" including		25	25	40	120	250	400	500	800	800	1200	1200	1200	2000	2000	3000	3000	3000	

r_{smaxr} , r_{1smaxr}	radial	0,2	0,3	0,5	0,8	1	1,5	2,2	2,6	2,7	3,5	4	4,5	5,5	6,5	8	10	12,5
r_{smaxa} , r_{1smaxa}	axial	0,2	0,3	0,5	0,8	1	1,5	2,2	2,6	2,7	3,5	4	4,5	5,5	6,5	8	10	12,5
Measuring distance "a"		0,7	0,8	1	1,3	1,5	2	2,6	3,1	3,2	4,2	4,8	5,4	6,6	7,8	9,6	12	15

Chamfer dimension of Radial Bearings, cylindrical bore

Dimensions in mm

1,5	2	2	2	2,1	2,1	2,5	2,5	2,5	2,5	3	3	4	5	6	7,5	r_{smin} , r_{1smin}	
400		80	220		280		100	280	800		280					over	Nominal bearing
800	80	220	800	280	1200	100	280	800	1200	280	1200	1200	2000	3 000	3 000	to	bore diameter "d"
3,5	3	3,5	3,8	4	4,5	3,8	4,5	5	5	5	5,5	6,5	8	10	12,5	Radial	r_{smaxr} , r_{1smaxr}
5	4,5	5	6	6,5	7	6	6	7	7,5	8	8	9	10	13	17	Axial	r_{smaxa} , r_{1smaxa}
6	5,4	6	7,2	7,8	8,4	7,2	7,2	8,4	9	9,6	9,6	10,8	12	15,6	20,4		Measuring distance "a"

Corner dimensions of Radial Bearings, tapered bore

Dimensions in mm

0,7	0,7	0,8	0,9	0,9	1	0,9	1	1,1	1,1	1,2	1,2	1,5	1,8	2,2	3	r_{smin} , r_{1smin}	
400		80	220		280		100	280	800		280					over	Nominal bearing
800	80	220	800	280	1200	100	280	800	1200	280	1200	1200	2000	3 000	3 000	to	bore diameter "d"
2,1	2,1	2,4	2,7	2,7	3	2,7	3	3,3	3,3	3,6	3,6	4,5	5,5	6,5	9	Radial	r_{smaxr} , r_{1smaxr}
3,5	3,5	4	4,5	4,5	5	4,5	5	5,5	5,5	6	6	7,5	9	11	15	Axial	r_{smaxa} , r_{1smaxa}
4,2	4,2	4,8	5,4	5,4	6	5,4	6	6,6	6,6	7,2	7,2	9	10,8	13,2	18		Measuring distance "a"

Machining tolerances for mating parts

Definitions

Machining tolerances for mating parts

The performance capability of super precision bearings in terms of speed-ability and running accuracy is continuously increasing. However, only if the precision of the mating parts is in line with that of the bearings, will it be possible to exploit this enhanced performance capability.

The tolerances of dimension, form and position listed in the following tables have proven suitable in many applications of super precision bearings. The values are a means for better and quicker fit selection and ensure reliable function and exchangeability. The mean roughness values R_a of the bearing seats must not be exceeded so that the recommended fits remain within a limit of alteration (smoothing).

The universally applicable rules of rolling bearing technology which consider the

- direction and effect of load
 - rotation of inner or outer ring
 - alteration of fit due to temperatures and centrifugal forces
- must also be observed.

Shaft

Tolerance symbols

- d = Nominal shaft diameter or Bearing bore
- d' = Small taper diameter (= d + lower tolerance in table)
- d_1' = Large taper diameter
 $d_1' = d' + 1/12 \cdot L$
- L = Length of taper
 $L = 0,95 \cdot B$
(bearing width)
- t_1 Ⓜ = Cylindricity (DIN ISO 1101)
- t_2 ⊘ = Roundness (DIN ISO 1101)
- t_3 ▭ = Flatness tolerance (DIN ISO 1101)
- t_4 ↗ = Axial runout tolerance (DIN ISO 1101)
- t_5 ⊙ = Coaxiality tolerance (DIN ISO 1101)
- AT_D = Taper angle tolerance (DIN 7178)
- R_a = Mean roughness value (DIN 4768)

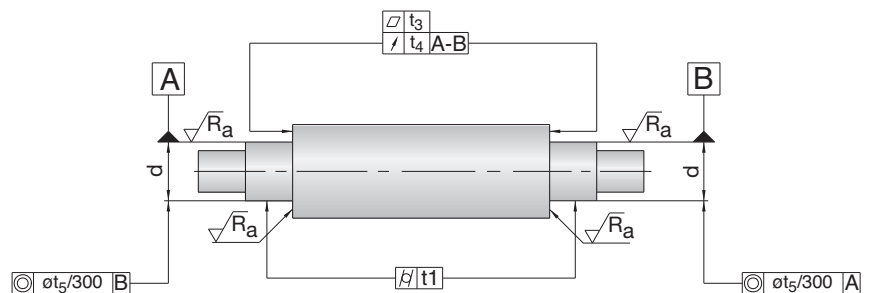
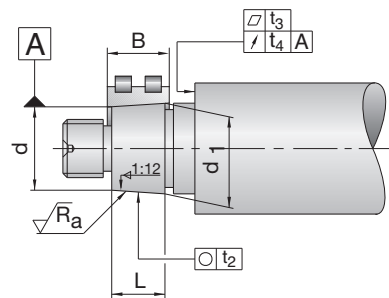

Housings

Tolerance symbols

- D = Nominal housing bore
- t_1 ⌀ = Cylindricity (DIN ISO 1101)
- t_3 \square = Flatness tolerance (DIN ISO 1101)
- t_4 \nearrow = Axial runout tolerance (DIN ISO 1101)
- t_5 \odot = Coaxiality tolerance (DIN ISO 1101)
- R_a = Mean roughness value (DIN 4768)

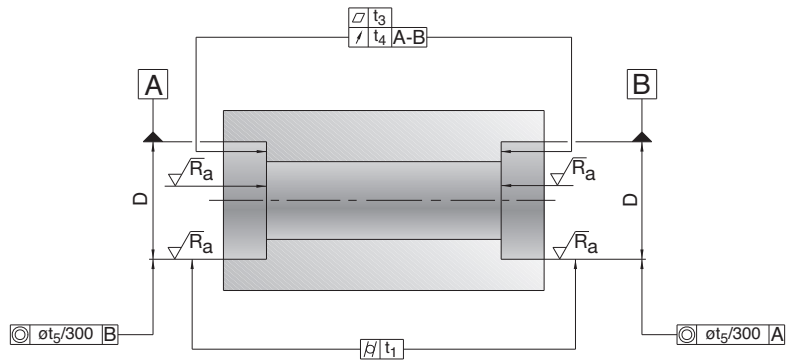

Spacer sleeves

Tolerance symbols

- d_2 = Nominal spacer sleeve bore
- D_2 = Cylindrical form tolerance
- t_1 ⌀ = Cylindricity (DIN ISO 1101)
- t_4 \nearrow = Axial runout tolerance (DIN ISO 1101)
- t_6 \parallel = Parallelism tolerance (DIN ISO 1101)
- t_7 \nearrow = Radial runout (DIN ISO 1101)
- R_a = Mean roughness value (DIN 4768)

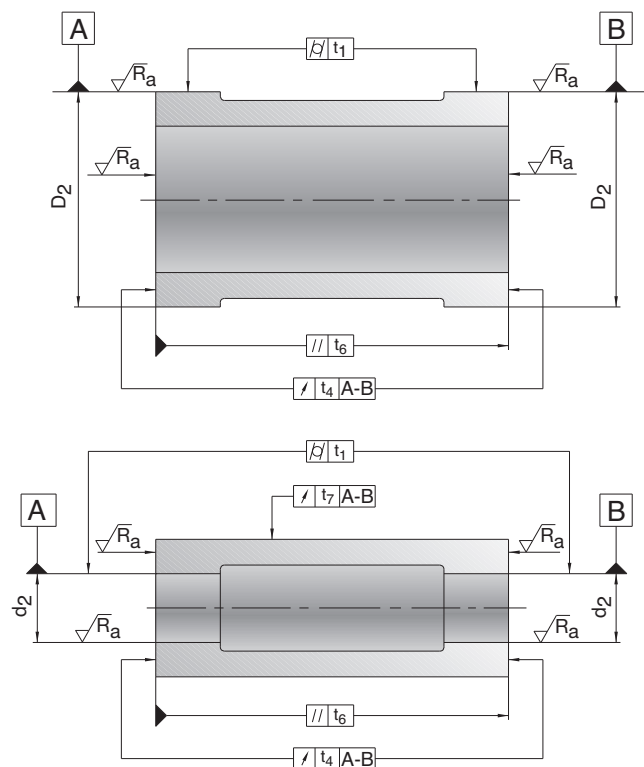

Machining tolerances for mating parts shafts and housings for Spindle Bearings

Tolerance recommendations for machining the shafts for Spindle Bearings								
		Dimensions in mm						
Nominal shaft diameter d	over	10	18	30	50	80	120	
	including	10	18	30	50	80	120	180
Tolerances in μm								
Deviation of d		2	2,5	3	3,5	4	5	6
		-2	-2,5	-3	-3,5	-4	-5	-6
Cylindricity	t_1	0,6	0,8	1	1	1,2	1,5	2
Flatness	t_3	0,6	0,8	1	1	1,2	1,5	2
Axial runout	t_4	1	1,2	1,5	1,5	2	2,5	3,5
Coaxiality	t_5	2,5	3	4	4	5	6	8
Mean roughness	R_a	0,2	0,2	0,2	0,2	0,4	0,4	0,4

Tolerance recommendations for machining the housings for Spindle Bearings								
		Dimensions in mm						
Nominal housing bore diameter D	over	10	18	30	50	80	120	180
	including	18	30	50	80	120	180	250
Tolerances in μm								
Deviation of D	Locating bearing	+3	+4	+4	+5	+6	+8	+10
		-2	-2	-3	-3	-4	-4	-4
	Floating bearing	+7	+8	+10	+11	+14	+17	+21
		+2	+2	+3	+3	+4	+5	+7
Cylindricity	t_1	1,2	1,5	1,5	2	2,5	3,5	4,5
Flatness	t_3	1,2	1,5	1,5	2	2,5	3,5	4,5
Axial runout	t_4	2	2,5	2,5	3	4	5	7
Coaxiality	t_5	3	4	4	5	6	8	10
Mean roughness	R_a	0,4	0,4	0,4	0,4	0,8	0,8	0,8

Tolerance recommendations for machining the shafts for Spindle Bearings

Dimensions in mm							over including	Nominal shaft diameter d
180	250	315	400	500	630	800		
250	315	400	500	630	800			

Tolerances in μm

Tolerances in μm							Deviation of d
7	8	9	10	11	12		
-7	-8	-9	-10	-11	-12		
3	4	5	6	7	8	t_1	Cylindricity
3	4	5	6	7	8	t_3	Flatness
4,5	6	7	8	9	10	t_4	Axial runout
10	12	13	15	16	18	t_5	Coaxiality
0,4	0,8	0,8	0,8	0,8	0,8	R_a	Mean roughness

Tolerance recommendations for machining the housings for Spindle Bearings

Dimensions in mm							over to	Nominal housing bore diameter D
250	315	400	500	630	800	1000		
315	400	500	630	800	1000			

Tolerances in μm

Tolerances in μm							
+12	+13	+15	+16	+18	+21		
-4	-5	-5	-6	-6	-7		Locating bearing
+24	+27	+30	+33	+36	+42		Floating bearing
+8	+9	+10	+11	+12	+14		
6	7	8	9	10	11	t_1	Cylindricity
6	7	8	9	10	11	t_3	Flatness
8	9	10	11	12	14	t_4	Axial runout
12	13	15	16	18	21	t_5	Coaxiality
1,6	1,6	1,6	1,6	1,6	1,6	R_a	Mean roughness

Machining tolerances for mating parts

Inner and outer spacer sleeves

Tolerance recommendations for machining inner spacer sleeves								
		Dimensions in mm						
Nominal bore diameter d_2	over	10	18	30	50	80	120	
	including	10	18	30	50	80	120	180
Tolerances in μm								
Deviation of d_2		9	11	13	16	19	22	25
		0	0	0	0	0	0	0
Cylindricity	t_1	2,5	3	4	4	5	6	8
Axial runout	t_4	1	1,2	1,5	1,5	2	2,5	3,5
Parallelism	t_6	1	1,2	1,5	1,5	2	2,5	3,5
Radial runout	t_7	2,5	3	4	4	5	6	8
Mean roughness (incl. side faces)	R_a	0,4	0,4	0,4	0,4	0,4	0,8	0,8

Tolerance recommendations for machining outer spacer sleeves								
		Dimensions in mm						
Nominal outside diameter of the sleeve D_2	over	10	18	30	50	80	120	180
	including	18	30	50	80	120	180	250
Tolerances in μm								
Deviation of D_2		-6	-7	-9	-10	-12	-14	-15
		-17	-20	-25	-29	-34	-39	-44
Cylindricity	t_1	3	4	4	5	6	8	10
Axial runout	t_4	2	2,5	2,5	3	4	5	7
Parallelism	t_6	1,2	1,5	1,5	2	2,5	3,5	4,5
Mean roughness (incl. side faces)	R_a	0,4	0,4	0,4	0,4	0,8	0,8	0,8

If not explicitly prescribed in the drawing, both spacer sleeves should have the same length. For this purpose, the side faces of the two sleeves should be ground in one chucking.

Tolerance recommendations for machining inner spacer sleeves

Dimensions in mm						over including	Nominal bore diameter d_2
180	250	315	400	500	630		
250	315	400	500	630	800		

Tolerances in μm

29	32	36	40	44	50		Deviation of d_2
0	0	0	0	0	0		
10	12	13	15	16	18	t_1	Cylindricity
4,5	6	7	8	9	10	t_4	Axial runout
4,5	6	7	8	9	10	t_6	Parallelism
10	12	13	15	16	18	t_7	Radial runout
0,8	1,6	1,6	1,6	1,6	1,6	R_a	Mean roughness (incl. side faces)

Tolerance recommendations for machining outer spacer sleeves

Dimensions in mm						over to	Nominal outer diameter of the sleeve D_2
250	315	400	500	630	800		
315	400	500	630	800	1000		

Tolerances in μm

-17	-18	-20	-22	-24	-27		Deviation of D_2
-49	-54	-60	-66	-74	-83		
12	13	15	16	18	21	t_1	Cylindricity
8	9	10	11	12	14	t_4	Axial runout
6	7	8	9	10	11	t_6	Parallelism
1,6	1,6	1,6	1,6	1,6	1,6	R_a	Mean roughness (incl. side faces)

Machining tolerances for mating parts

Cylindrical shafts and housings for Cylindrical Roller Bearings

Tolerance recommendations for machining the cylindrical shafts for Cylindrical Roller Bearings								
		Dimensions in mm						
Nominal shaft diameter d	over	18	30	50	80	120	180	250
	including	30	50	80	120	180	250	315

Tolerance class SP		Tolerances in μm						
Deviation of d		3	3,5	4	5	6	7	8
		-3	-3,5	-4	-5	-6	-7	-8
Cylindricity	t_1	1	1	1,2	1,5	2	3	4
Flatness	t_3	1	1	1,2	1,5	2	3	4
Axial runout	t_4	1,5	1,5	2	2,5	3,5	4,5	6
Coaxiality	t_5	4	4	5	6	8	10	12
Mean roughness	R_a	0,2	0,2	0,4	0,4	0,4	0,4	0,8

Tolerance class UP		Tolerances in μm						
Deviation of d		2	2	2,5	3	4	5	6
		-2	-2	-2,5	-3	-4	-5	-6
Cylindricity	t_1	0,6	0,6	0,8	1	1,2	2	2,5
Flatness	t_3	0,6	0,6	0,8	1	1,2	2	2,5
Axial runout	t_4	1	1	1,2	1,5	2	3	4
Coaxiality	t_5	2,5	2,5	3	4	5	7	8
Mean roughness	R_a	0,2	0,2	0,2	0,2	0,2	0,2	0,4

Tolerance recommendations for machining the housings for Cylindrical Roller Bearings								
		Dimensions in mm						
Nominal housing bore diameter D	over	30	50	80	120	180	250	315
	including	50	80	120	180	250	315	400

Tolerance class SP		Tolerances in μm						
Deviation of D		+2	+3	+2	+3	+2	+3	+3
		-9	-10	-13	-15	-18	-20	-22
Cylindricity	t_1	1,5	2	2,5	3,5	4,5	6	7
Flatness	t_3	1,5	2	2,5	3,5	4,5	6	7
Axial runout	t_4	2,5	3	4	5	7	8	9
Coaxiality	t_5	4	5	6	8	10	12	13
Mean roughness	R_a	0,4	0,4	0,8	0,8	0,8	1,6	1,6

Tolerance class UP		Tolerances in μm						
Deviation of D		+1	+1	+1	+1	0	0	+1
		-6	-7	-9	-11	-14	-16	-17
Cylindricity	t_1	1	1,2	1,5	2	3	4	5
Flatness	t_3	1	1,2	1,5	2	3	4	5
Axial runout	t_4	1,5	2	2,5	3,5	4,5	6	7
Coaxiality	t_5	2,5	3	4	5	7	8	9
Mean roughness	R_a	0,2	0,4	0,4	0,4	0,4	0,8	0,8

Tolerance Recommendations for machining the cylindrical shafts for Cylindrical Roller Bearings

Dimensions in mm					
315	400	500	630	over	Nominal shaft
400	500	630	800	including	diameter d

Tolerances in μm				Tolerance class SP	
9	10	11	12		Deviation of d
-9	-10	-11	-12		
5	6	7	8	t_1	Cylindricity
5	6	7	8	t_3	Flatness
7	8	9	10	t_4	Axial runout
13	15	16	18	t_5	Coaxiality
0,8	0,8	0,8	0,8	R_a	Mean roughness

Tolerances in μm				Tolerance class UP	
6,5	7,5	8	9		Deviation of d
-6,5	-7,5	-8	-9		
3	4	5	5	t_1	Cylindricity
3	4	5	5	t_3	Flatness
5	6	7	8	t_4	Axial runout
9	10	11	12	t_5	Coaxiality
0,4	0,4	0,4	0,4	R_a	Mean roughness

Tolerance Recommendations for machining the housings for Cylindrical Roller Bearings

Dimensions in mm					
400	500	630	800	over	Nominal housing bore
500	630	800	1000	to	diameter D

Tolerances in μm				Tolerance class SP	
+2	0	0	0		Deviation of D
-25	-29	-32	-36		
8	9	10	11	t_1	Cylindricity
8	9	10	11	t_3	Flatness
10	11	12	14	t_4	Axial runout
15	16	18	21	t_5	Coaxiality
1,6	1,6	1,6	1,6	R_a	Mean roughness

Tolerances in μm				Tolerance class UP	
0	0	0	0		Deviation of D
-20	-22	-24	-27		
6	7	8	9	t_1	Cylindricity
6	7	8	9	t_3	Flatness
8	9	10	11	t_4	Axial runout
10	11	12	14	t_5	Coaxiality
0,8	1,6	1,6	1,6	R_a	Mean roughness

Machining tolerances for mating parts

Tapered shafts for single and Double Row Cylindrical Roller Bearings and taper angles

Tolerance recommendations for machining the tapered shafts for Cylindrical Roller Bearings

		Dimensions in mm										
Nominal shaft diameter d or Bearing bore	over	18	30	40	50	65	80	100	120	140	160	180
	including	30	40	50	65	80	100	120	140	160	180	200

Tolerance class SP Tolerances in μm

Deviation of small-end taper diameter *	upper deviation	+73	+91	+108	+135	+159	+193	+225	+266	+298	+328	+370
	lower deviation	+64	+80	+97	+122	+146	+178	+210	+248	+280	+310	+350
Roundness	t_2	1	1	1	1,2	1,2	1,5	1,5	2	2	2	3
Flatness	t_3	1	1	1	1,2	1,2	1,5	1,5	2	2	2	3
Axial runout	t_4	1,5	1,5	1,5	2	2	2,5	2,5	3,5	3,5	3,5	4,5
Mean roughness	R_a	0,2	0,2	0,2	0,2	0,2	0,2	0,2	0,2	0,2	0,2	0,2

Tolerance class UP Tolerances in μm

Deviation of small-end taper diameter *	upper deviation	+73	+91	+108	+135	+159	+193	+225	+266	+298	+328	+370
	lower deviation	+64	+80	+97	+122	+146	+178	+210	+248	+280	+310	+350
Roundness	t_2	0,6	0,6	0,6	0,8	0,8	1	1	1,2	1,2	1,2	2
Flatness	t_3	0,6	0,6	0,6	0,8	0,8	1	1	1,2	1,2	1,2	2
Axial runout	t_4	1	1	1	1,2	1,2	1,5	1,5	2	2	2	3
Mean roughness	R_a	0,2	0,2	0,2	0,2	0,2	0,2	0,2	0,2	0,2	0,2	0,2

* relating to d (see example page 173)

Deviation of taper angle

		Dimensions in mm					
Nominal width of the taper length L		>16...25	>25...40	>40...63	>63...100	>100...160	>160...250

Tolerance class SP Tolerances in μm

Taper angle tolerance	AT_D	+2	+3,2	+2,5	+4	+3,2	+5	+4	+6,3	+5	+8	+6,3	+10
		0	0	0	0	0	0	0	0	0	0	0	0

Tolerance class UP Tolerances in μm

Taper angle tolerance	AT_D	+1,3	+2	+1,6	+2,5	+2	+3,2	+2,5	+4	+3,2	+5	+4	+6,3
		0	0	0	0	0	0	0	0	0	0	0	0

The taper angle tolerance AT_D is measured vertically to the axis and is defined as a diameter difference.

When using FAG taper measuring instruments MGK 132, the listed AT_D values must be cut by half (inclination angle tolerance).

For taper lengths the nominal dimensions of which lie in between the values listed in the tables, the taper angle tolerance AT_D is determined through interpolation.

Example: Taper length 50 mm, bearing of tolerance class SP.

$$AT_D = \frac{\Delta AT_D}{\Delta L} \cdot L = \frac{5 - 3,2}{63 - 40} \cdot 50 = \frac{1,8}{23} \cdot 50 = 3,9 \mu\text{m} \quad \text{The taper angle tolerance } AT_D = +4 \mu\text{m}$$

Tolerance recommendations for machining the tapered shafts for Cylindrical Roller Bearings

Dimensions in mm												over including	Nominal shaft diameter d or Bearing bore
200	225	250	280	315	355	400	450	500	560	630			
225	250	280	315	355	400	450	500	560	630	710			

Tolerances in μm												Tolerance class SP	
+405	+445	+498	+548	+615	+685	+767	+847	+928	+1008	+1092	upper deviation	Deviation of small-end taper diameter *	
+385	+425	+475	+525	+590	+660	+740	+820	+900	+980	+1060	lower tolerance		
3	3	4	4	5	5	6	6	7	7	8	t_2	Roundness	
3	3	4	4	5	5	6	6	7	7	8	t_3	Flatness	
4,5	4,5	6	6	7	7	8	8	9	9	10	t_4	Axial runout	
0,2	0,2	0,4	0,4	0,4	0,4	0,4	0,4	0,4	0,4	0,4	t_5	Mean roughness	

Tolerances in μm												Tolerance class UP	
+405	+445	+498	+548	+615	+685	+767	+847	+928	+1008	+1092	upper deviation	Deviation of small-end taper diameter *	
+385	+425	+475	+525	+590	+660	+740	+820	+900	+980	+1060	lower tolerance		
2	2	2,5	2,5	3	3	4	4	5	5	5	t_2	Roundness	
2	2	2,5	2,5	3	3	4	4	5	5	5	t_3	Flatness	
3	3	4	4	5	5	6	6	7	7	8	t_4	Axial runout	
0,2	0,2	0,4	0,4	0,4	0,4	0,4	0,4	0,4	0,4	0,4	R_a	Mean roughness	

* relating to d

Example: Bearing bore 70, Tolerance class SP; Dimensions in mm
 Small taper diameter $d' = d + \text{lower tolerance} = 70 + 0,146 = 70,146$
 Tolerance = upper tolerance - lower tolerance = $0,159 - 0,146 = (+) 0,013$

Machining tolerances for mating parts

Shafts and housings for Double Direction Angular Contact Thrust Ball Bearings (2344, 2347)

Tolerance recommendations for machining the shafts for Double Direction Angular Contact Thrust Ball Bearings for Main Spindles (2344..., 2347..)

		Dimensions in mm						
Nominal shaft diameter d	over	18	30	50	80	120	180	250
	including	30	50	80	120	180	250	315

Tolerance class SP Tolerances in μm

Deviation of d		0	0	0	0	0	0	0
		-6	-7	-8	-10	-12	-14	-16
Cylindricity	t_1	1	1	1,2	1,5	2	3	4
Flatness	t_3	1	1	1,2	1,5	2	3	4
Axial runout	t_4	1,5	1,5	2	2,5	3,5	4,5	6
Mean roughness	R_a	0,2	0,2	0,4	0,4	0,4	0,4	0,8

Tolerance class UP Tolerances in μm

Deviation of d		0	0	0	0	0	0	0
		-4	-4	-5	-6	-8	-10	-12
Cylindricity	t_1	0,6	0,6	0,8	1	1,2	2	2,5
Flatness	t_3	0,6	0,6	0,8	1	1,2	2	2,5
Axial runout	t_4	1	1	1,2	1,5	2	3	4
Mean roughness	R_a	0,2	0,2	0,2	0,2	0,2	0,2	0,4

Tolerance recommendations for machining the housings for Double Direction Angular Contact Thrust Ball Bearings for Main Spindles (2344..., 2347..)

		Dimensions in mm						
Nominal housing bore diameter D	over	30	50	80	120	180	250	315
	including	50	80	120	180	250	315	400

Tolerance class SP Tolerances in μm

Deviation of D		+2	+3	+2	+3	+2	+3	+3
		-9	-10	-13	-15	-18	-20	-22
Cylindricity	t_1	1,5	2	2,5	3,5	4,5	6	7
Flatness	t_3	1	1,2	1,5	2	3	4	5
Axial runout	t_4	1,5	2	2,5	3,5	4,5	6	7
Mean roughness	R_a	0,8	0,8	0,8	0,8	0,8	1,6	1,6

Tolerance class UP Tolerances in μm

Deviation of D		+1	+1	+1	+1	0	0	+1
		-6	-7	-9	-11	-14	-16	-17
Cylindricity	t_1	1	1,2	1,5	2	3	4	5
Flatness	t_3	0,6	0,8	1	1,2	2	2,5	3
Axial runout	t_4	1	1,2	1,5	2	3	4	5
Mean roughness	R_a	0,2	0,4	0,4	0,4	0,4	0,8	0,8

Tolerance recommendations for machining the shafts for Double Direction Angular Contact Thrust Ball Bearings for Main Spindles (2344.., 2347..)

Dimensions in mm			
315	400	over	Nominal shaft
400	500	including	diameter d

Tolerances in μm Tolerance class SP

0	0		Deviation of d
-18	-20		
5	6	t_1	Cylindricity
5	6	t_3	Flatness
7	8	t_4	Axial runout
0,8	0,8	R_a	Mean roughness

Tolerances in μm Tolerance class UP

0	0		Deviation of d
-13	-15		
3	4	t_1	Cylindricity
3	4	t_3	Flatness
5	6	t_4	Axial runout
0,4	0,4	R_a	Mean roughness

Tolerance recommendations for machining the housings for Double Direction Angular Contact Thrust Ball Bearings for Main Spindles (2344.., 2347..)

Dimensions in mm				
400	500	630	over	Nominal housing bore
500	630	800	including	diameter D

Tolerances in μm Tolerance class SP

+2	0	0		Deviation of D
-25	-30	-32		
8	9	10	t_1	Cylindricity
6	7	8	t_3	Flatness
8	9	10	t_4	Axial runout
1,6	1,6	1,6	R_a	Mean roughness

Tolerances in μm Tolerance class UP

0	0	0		Deviation of D
-20	-22	-24		
6	7	8	t_1	Cylindricity
4	5	6	t_3	Flatness
6	7	8	t_4	Axial runout
0,8	1,6	1,6	R_a	Mean roughness

Engineering

Lubrication

Lubrication

An important precondition for

- adequate bearing service life,
- wear-free operation and
- low vibration level

is a lubricating film that separates the rolling elements in the contact zone.

In order to achieve this

- the constant presence of a lubricant at all contact points must be ensured,
- so that the appropriate lubrication method is specified for the required speed and
- a lubricant with appropriate properties has to be selected.

Lubricant viscosity

The condition of the lubricant film is determined by the viscosity ratio κ , which is defined as a quotient of operating viscosity v and rated viscosity v_1 .

Rated viscosity v_1 is a function of bearing size and speed and can be ascertained from diagram 1. Operating viscosity is the actual existing lubrication viscosity in operation. It is an operating temperature and lubricant base viscosity function and can be ascertained from diagram 2. Base oil viscosity is determined when greasing. Viscosity at an operating temperature of at least double that of the rated viscosity should be aimed at, $\kappa = v/v_1 \geq 2$. Higher viscosity ratios do not improve lubricant film, but increase friction.

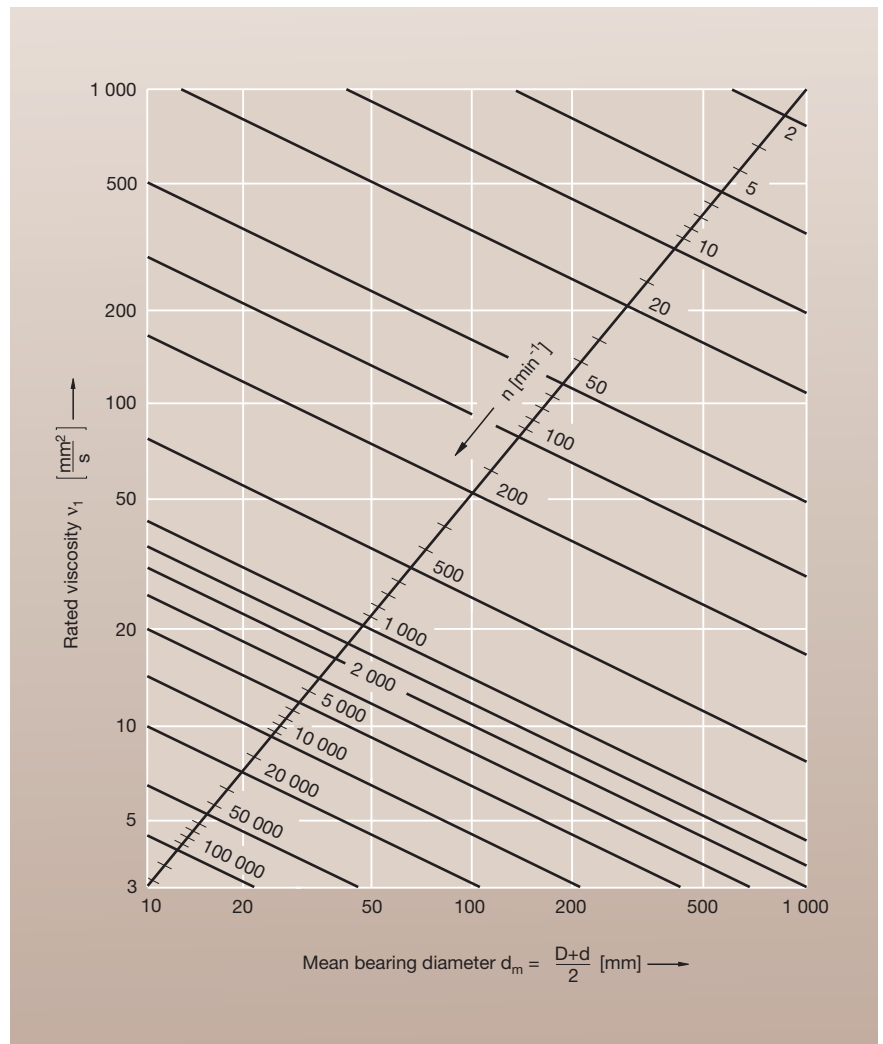

1: Rated viscosity v_1

Engineering

Lubrication

Lubrication methods

Lubrication method selection is based on the maximum required bearing operating speed. In this catalog's table, the maximum speed is shown for both of the most important lubrication methods used for super precision bearings, grease lubrication and oil lubrication. These valid speeds for single bearings can be ascertained through rigidly preloaded bearing arrangements by multiplying with reduction factors according Table 14.

Super precision bearings are predominantly grease-lubricated. The essential advantages of grease lubrication include:

- low friction
- for-life lubrication
- simple designs
- low system costs.

Minimum oil quantity lubrication is employed when the spindle speed is beyond the range of grease lubrication. When high speed indices are driven over long intervals of time, it can make sense to use minimal oil quantity lubrication in order to achieve a stipulated lubricant service life. This can also be appropriate in cases, in which grease-lubrication is still possible according to the speed parameter because the grease operating life (fig.5) decreases with increased speed.

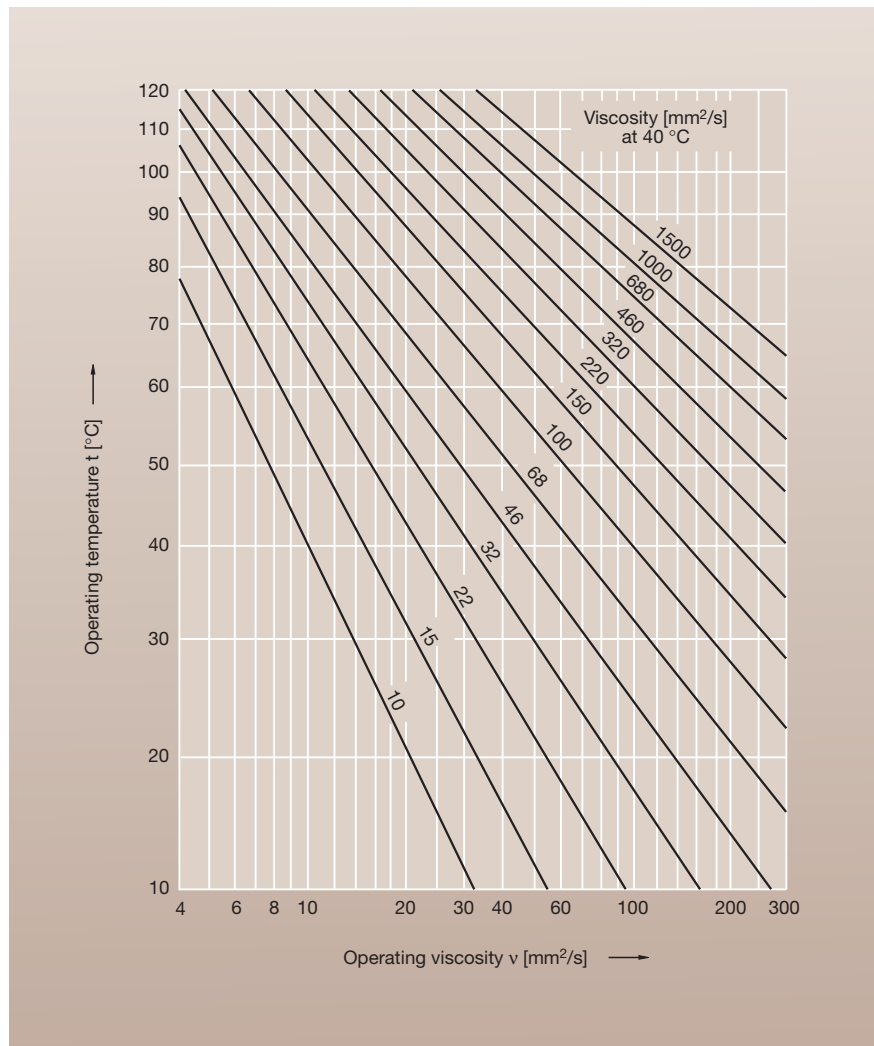

2: V-T diagram

Engineering

Lubrication

Grease lubrication

The development in the grease and bearing field has led to an enormous performance increase in particular with respect to attainable speeds. Speed indices $n \cdot d_m$ of up to 2 000 000 mm/min are attainable today.

The use of spindle bearings supplied with initial “for-life” grease filling and seals offer further advantages, for instance utmost cleanliness as the bearing interior is protected against contamination. In addition, handling during mounting is easier. Suitable greases for super precision bearings are listed in Table 3.

FAG ARCANOL L075 is a high-performance grease for a wide range of high-speed spindle bearing applications up to constant temperatures of 80 °C, measured at the outer ring. Since temperatures in motor spindles will hardly reach 80 °C due to standard liquid cooling, L075 can be called the spindle bearing standard grease.

FAG ARCANOL L210 is another high-speed grease. Thanks to its higher base oil viscosity it is used at constant temperatures higher than 80 °C up to approx. 100 °C.

FAG ARCANOL L055 is a high-pressure grease that is well-proven in shaft end bearing applications for ball screw drives, Indexing Table Bearings and also in tailstock centre bearing arrangements.

FAG Grease ARCANOL	L075	L210	L055
Designation DIN 51 502	KE3K-50	KHC3P-40	KP2N-40
Thickener	Polyurea	Polyurea	Lithium
Base oil	PAO/ester	PAO/ester	Mineral oil + ester
Base oil viscosity mm ² /s at 40 °C at 100 °C	22 5	65 10	85 12,5
Consistency class	3	3	2
Operating temperature without Reduction of service °C	up to 80	up to 100	up to 70
Maximum Speed parameter* mm/min	2 000 000	1 300 000	800 000
Used as	high-speed grease		high-pressure grease
Standard grease in	HSS,HCS,XCS B,HCB...2RSD		
Specific weight (approx.) g/ccm	0,92	0,88	0,9
* Speed parameter $n \cdot d_m$ is the product of the mean bearing diameter and speed, (value valid for point load)			

3: Rolling bearing greases for super precision bearings

Grease quantity

Each bearing type requires different grease quantities. The recommendations in Table 4 are adjusted to the bearing volume that is not disturbed by rotating components. Information on greasing can be found in section Mounting guidelines (page 204 ff).

4: Recommended grease quantities in cm³ (opposite page)

Engineering

Lubrication

Grease service life

The grease service life is the time over which proper bearing function is sustained by a particular quantity of grease. It depends on following factors:

- grease quantity
- grease type
- bearing type
- speed
- temperature
- installation, operating and environmental conditions.

In many applications of super precision bearings, the grease service life is the decisive factor for the life of the bearing arrangement in comparison to the bearing fatigue life. It can be found in diagram 5.

Diagram 5 applies to high-speed greases. Unfavorable operating and environmental conditions including humidity, vibration or air flow through the bearings have to be taken into consideration if applicable.

When operating at varying speeds with established durations, the entire grease service life can be calculated according to the following formula:

$$F_{10ges} = \frac{100}{\sum_{i=1}^n \frac{q_i}{F_{10i}}}$$

Here, q_i represents durations in percentage and F_{10i} represents the grease service life of the speed group's individual speeds.

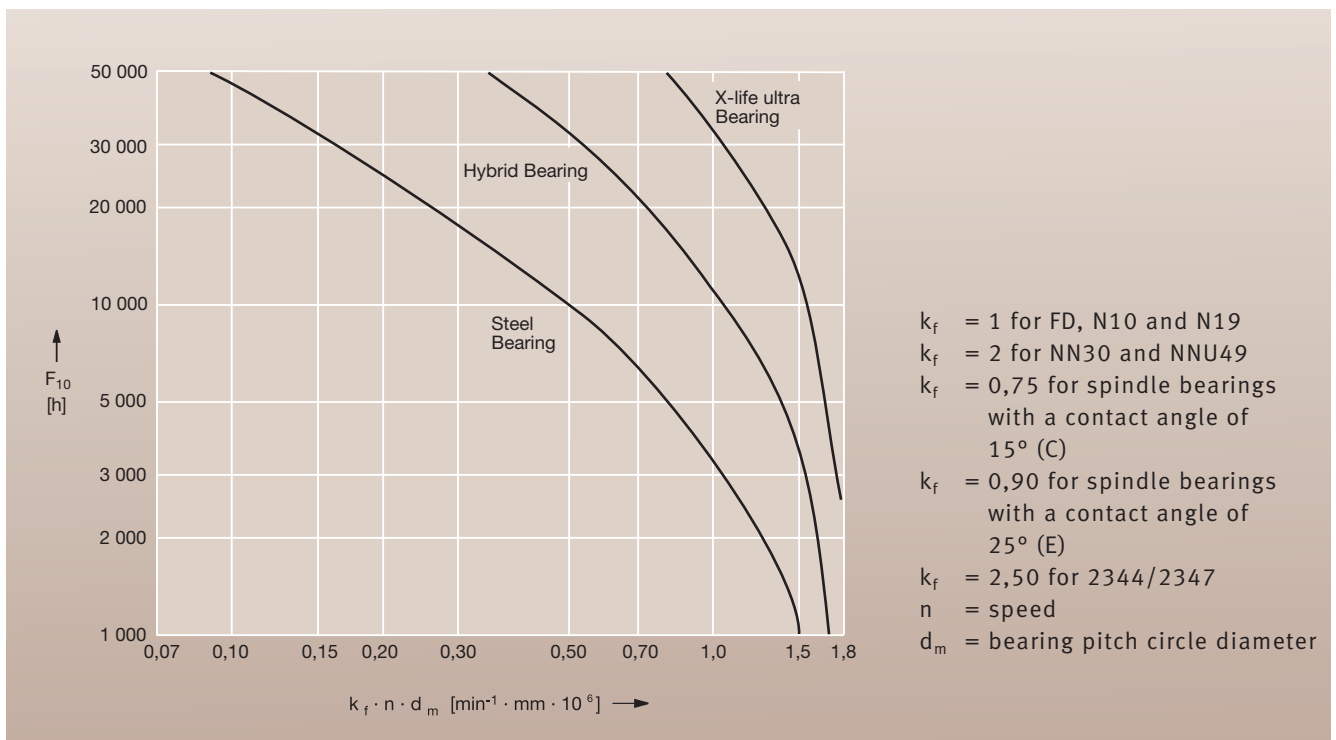

5: Grease Service Life F_{10}

Engineering

Lubrication

Grease distribution run

The correct initial operation of grease-lubricated bearing arrangements has great influence on the performance and service life of a bearing arrangement. A start-stop operation is recommended for grease distribution. This prevents excessively high damaging temperatures in the contact area. During the stop phase a temperature balance takes place between the individual bearing components so

that damaging preloading conditions do not occur. It is recommended that the temperature development during the grease distribution run and the following continuous operation be monitored by means of a temperature sensor located as close to the bearing outer ring as possible. A progressive rise in temperature that occurs for instance under conditions of excessive preloading, must be avoided at all costs. The grease distribution is complete when a

stable bearing temperature has been reached. For maximum speeds, the run-in procedure should initially be carried out at half speed, prior to operation at maximum speed. Figure 6 shows recommendations for grease distribution runs of open and sealed spindle bearings. The grease quantity, Table 4, and the grease distribution run, Figure 6, are available as laminated cards in DIN A5 format for use in workshops.

The run-in procedure consists of several cycles of a start-stop operation with differing speeds and operating periods, the standstill periods after each run being particularly important. The required number of cycles may differ depending on bearing size, bearing number, maximum speeds and bearing environment.

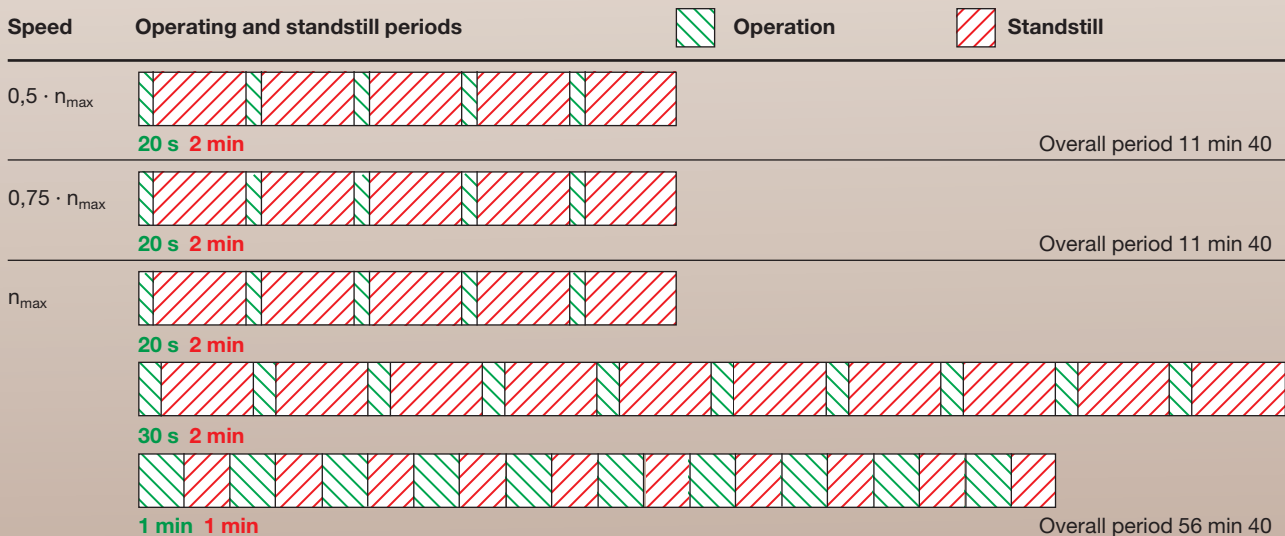

Further cycles with extended operating periods and shorter standstill periods should be carried out until a steady-state temperature has been reached.

6: Recommendations for grease distribution runs of open and sealed spindle bearings

Engineering

Lubrication

Minimal oil quantity lubrication

FAG spindle bearings require very little oil. An amount of approx. $100 \text{ mm}^3/\text{h}$ is sufficient, provided that all rolling and sliding contact areas are wetted with oil. Minimal oil quantity lubrication keeps frictional losses to a minimum. It is employed when the spindle speed is beyond the range of grease lubrication. The standard method today is oil-air lubrication. Speeds attainable with minimal oil quantity lubrication are listed in the bearing table.

Oils according to the designation ISO VG 68 + EP, meaning a nominal viscosity of $68 \text{ mm}^2/\text{s}$ at $40 \text{ }^\circ\text{C}$ and Extreme Pressure additives have proven suitable. Guide values for the minimal oil quantity required

for oil lubrication are shown in Diagram 7. Specific flow conditions in the bearing arrangement can substantially influence the required oil quantity.

The oil quantity data for hybrid bearings should be taken more from the higher part of the range, while the data for steel bearings should be taken more from the lower part of the range.

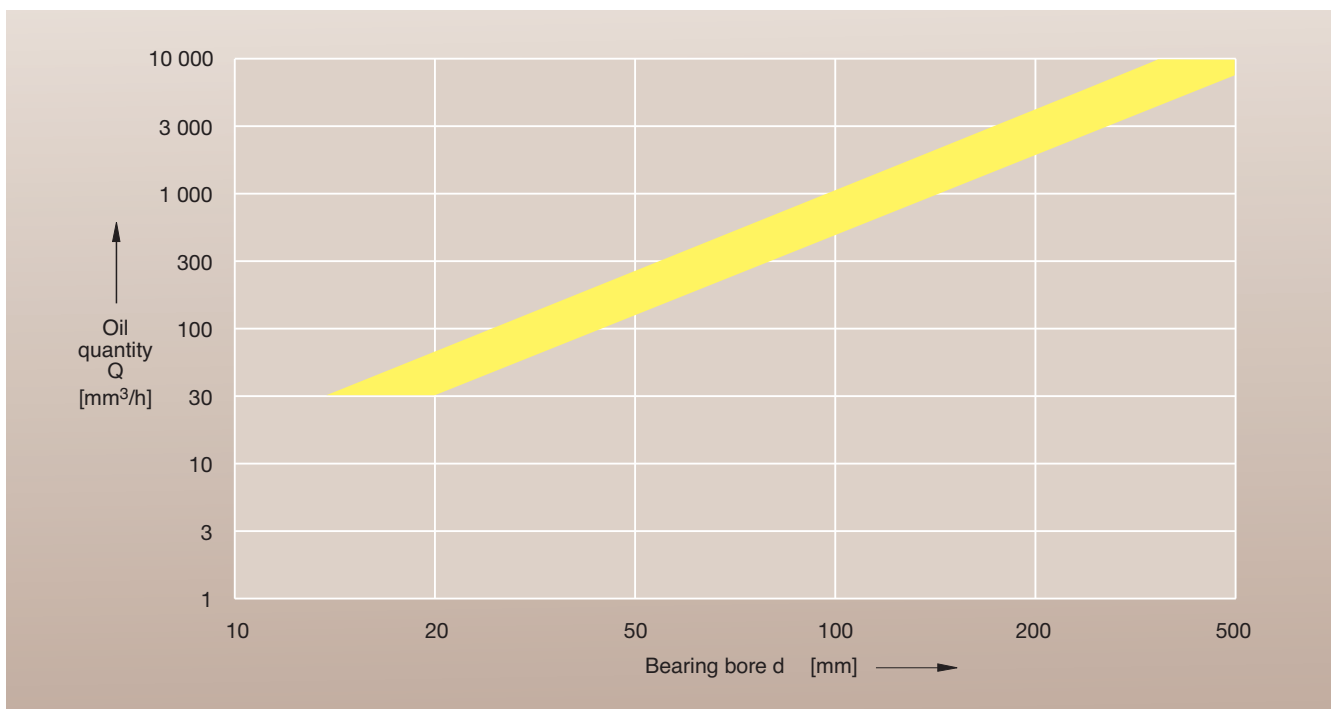

7: Oil quantity required for oil-air lubrication of FAG spindle bearings

Engineering

Lubrication

Recommendations for oil-air lubrication

for B, HCB, HS, HC, XC- spindle bearings, also in Direct-Lube design (DLR):

Oil cleanliness class:	13/10 (ISO 4406)
Air cleanliness:	Particle size 0,01 μm max.
Air dryness:	Dew point at + 2° C
Air inlet tube pressure:	approx. 3 bars
Nozzle diameter:	0,5 to 1 mm.
Number of nozzles:	Extra nozzles for each bearing, one nozzle per every 150 mm of pitch circle circumference
Nozzle design:	Inlet tube parallel to spindle rotational axis between inner ring lip and cage bore
Injection-pitch circle diameter:	See bearing tables (E_{tk}) (The injection pitch circle can deviate slightly from table details for spindle bearings with TX-cage).
Inlet tubes:	Inner diameter 2 to 2,5 mm, flexible and transparent tubing of synthetic material; thus the oil stream at the inner tube wall is visible.
Length:	At least 1 m, optimum 4 m, up to approx. 10 m. Spirals with some five windings, centre axis horizontal or up to 30° inclined, no closer than approx. 500 mm in front of the nozzle. When lubrication is interrupted, the oil will collect in the windings at the bottom and soon be available again when operation is resumed. Thus a short lead time becomes possible for spindle starts.
Oil outlets:	At both sides of each bearing; oil collection can cause high temperature running. For vertical spindles outlet ducts should be provided underneath each bearing so that the bearings below will not be overlubricated. Outlet ducts $\varnothing \geq 5$ mm if possible. Connect all outlet ducts from all bearings on one spindle for pressure balance reasons.

Oil-air lubricating devices

Normal oil quantities per injection cycle: 3, 5, 10, (30, 60, 100) mm^3

Normal injection cycles per hour: 6 to 10

Further data can be obtained from manufacturers of oil-air lubricating devices.

Engineering

Service life of Super Precision Bearings

Service life of Super Precision Bearings

Super precision bearings must locate machinery components with high accuracy and support loads at up to very high speeds. They are predominantly selected for their

- accuracy
- rigidity
- running behavior.

These demands can be met over an expected life span only if no bearing wear occurs. This is dependent upon the generation of a supportive hydrodynamic lubricant film in the rolling contact area. Under these circumstances rolling bearings achieve ultimate life in a variety of applications. The life of fail-safe types is usually limited by the service life of the lubricant (see Table 5).

Under this aspect, stress occurring in the contact points of Hertzian contact stress as well as the bearing kinematics are decisive influences. It is better to determine individual bearing arrangements with the help of special calculation programs, especially for high-performance units. Since failure due to fatigue does not play a role with super precision bearings in practice, a rating life calculation L_{10} according to DIN ISO 281 in order to determine bearing service life is counter-productive.

Bearing load

Static load

For super precision bearings the static load, i.e. loading in the absence of ring rotation, is rarely checked. The stress index f_s as a measure of the static load is obtained from:



$$f_s = C_0/P_0$$

f_s = static stress index

C_0 = static load rating [kN]

P_0 = static equivalent load [kN]

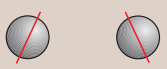
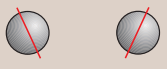
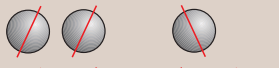
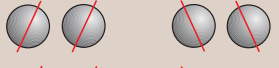
The static equivalent load is calculated from the axial and radial loads on the bearing (see below). External loads, according to Table 8, are distributed on individual bearings if there are several bearings. In each case, the bearing with the highest load has to be checked for carrying capacity.

Arrangement	Load on the highest loaded bearings	
	F_a	F_r
	100 %	60 %
	100 %	60 %
	50 %	60 %
	50 %	60 %
	33 %	60 %
	33 %	60 %

Radial and axial loads that are calculated from external loads as well as contact and location spacings are to be set on each bearing position.

Spindle bearings

Contact angle $\alpha = 15^\circ$

$$P_0 = F_r \text{ [kN]}$$

for $F_a/F_r \leq 1,09$

$$P_0 = 0,5 \cdot F_r + 0,46 \cdot F_a \text{ [kN]}$$

for $F_a/F_r > 1,09$

Contact angle $\alpha = 25^\circ$

$$P_0 = F_r \text{ [kN]}$$

for $F_a/F_r \leq 1,31$

$$P_0 = 0,5 \cdot F_r + 0,38 \cdot F_a \text{ [kN]}$$

for $F_a/F_r > 1,31$

8: Load distribution of one bearing position on several bearings.

Engineering

Service life of Super Precision Bearings

In order to maintain bearing accuracy, the static stress index should be higher than 3,0. Only with an extremely short-term and centric axial load (tool ejection force), $f_s \geq 1$ is admissible for hybrid bearings.

Double Direction Angular Contact Thrust Ball Bearings

$P_0 = F_a$
The static stress index should be higher than 2,5.

Floating Displacement Bearings and Cylindrical Roller Bearings

$$P_0 = F_r$$

The static stress index should be higher than 3,0.

Endurance strength

To check endurance strength, the stress index f_{s^*} is calculated according to the following equation:

$$f_{s^*} = C_0/P_{0^*}$$

The equivalent load calculation P_{0^*} occurs according to equations for the static equivalent load; however, with dynamic load forces.

The stress index is a measure for anticipating whether a bearing can be fail-safe in a specific application. If the factor is $f_{s^*} > 8$, then infinite service life can be assumed.

Individual calculations of Hertzian contact (see page 197) pressure and checking bearing kinematics is more accurate using a calculation program (see Appendix, page 226). If additional conditions of a separating lubricant film ($\kappa \geq 2$) and utmost cleanliness are met,

(D-d)/2 mm	Point Contact			Line contact		
	required oil cleanliness class in accordance to ISO 4406	required filter retention rate in accordance to ISO 4572	maximum ¹⁾ size of cycled particle µm	required oil cleanliness class in accordance to ISO 4406	required filter retention rate in accordance to ISO 4572	maximum size of cycled particle µm
up to 12,5	11/8	$\beta_3 \geq 200$	10	12/9	$\beta_3 \geq 200$	20
over 12,5 up to 20"	12/9	$\beta_3 \geq 200$	15	13/10	$\beta_3 \geq 75$	25
over 20 up to 35"	13/10	$\beta_3 \geq 75$	25	14/11	$\beta_3 \geq 75$	40
over 35	14/11	$\beta_3 \geq 75$	40	14/11	$\beta_3 \geq 75$	75

The oil cleanliness class as a measure of the probability of life-reducing particles being cycled in a bearing can be determined by means of oil samples, e.g. through filter manufacturers and institutes. The cleanliness class will be reached if the total oil quantity flows through the filter within a few minutes. To safely ensure a high degree of cleanliness, flushing is required prior to bearing operation.

A filtration ratio of $\beta_3 \geq 200$ means e.g., that only one particle out of 200 particles 3 µm passed through > the so-called Multi-Pass-Test. Filters coarser than $\beta_3 \geq 75$ should not be used due to detrimental effects on the other components within the oil circulation system.

¹⁾ Details apply when particles with a hardness > 50 HRC are no longer cycled in the highly loaded contact zone.

9: Guide values for recommended oil cleanliness classes

Engineering

Service life of Super Precision Bearings

then a life calculation is not required. If these conditions are not met, then an additional life calculation according to DIN ISO 281 supplement 1 for manual calculations or according to DIN ISO 281 supplement 4 for computer-aided processes can be used to estimate the influences of lubrication and contamination on service life.

Cleanliness

Cleanliness plays a very important role with super precision bearings, because the relative influence on the service life of generally lightly loaded bearings is very heavy and contamination greatly promotes wear.

Reference values for lubricant purity for bearings with oil lubrication have been adopted from the field of hydraulics and can be obtained from Table 9.

In practice, utmost cleanliness is ensured with greased bearings when the bearings are already greased and protected with seals by the manufacturer.

Operating temperatures

Super precision bearing rings are dimensionally stable up to 150 °C. Temperature influence on material properties do not have to be taken into account up to this value. Temperature limits of cage, sealing and lubricant have to be observed (see Table 10). For applications of super precision bearings at higher temperatures, please consult Schaeffler Group Industrial's engineering department.

Bearing Component	Temperature Limits
Cage	100 °C
Seal	100 °C
Lubricant	see chapter "Lubrication"
Bearing rings	150 °C

10: Temperature limits of bearing components

Engineering

Speed dependent fits

Speed dependent fits

FAG super precision bearings are suitable for the highest speeds. Speed indices of $n \cdot d_m$ up to $2,0 \cdot 10^6$ mm/min are attainable with grease lubrication, while oil-lubricated bearings can attain speeds as high as $3,0 \cdot 10^6$ mm/min and beyond.

Such high speeds cause high centrifugal forces which act on the inner rings and cause them to expand. This ring expansion leads to a lifting off of the inner ring from the shaft and thus to clearance between inner ring and shaft.

Possible results of this process are:

- Fretting corrosion
- Turning of the ring on the shaft
- poor shaft support with increased tendency to vibration
- reduced bearing performance due to possible misalignment.

These effects can be avoided through a correspondingly tight fit on the shaft.

The required interference can be obtained from Diagram 11 or calculated with the help of the BEARINX® program. The values determined in this way yield a fit with a remaining interference of $1 \mu\text{m}$ at maximum speed.

High interference leads to an increase in preload, in particular in the case of rigid adjusted bearings. This in turn leads to increased heat generation in the bearing arrangement as well as losses in terms of speed-ability. This preload increase must be compensated by appropriate measures. With values $f_w \cdot n^2 > 1,2$ (red zone in Diagram 11), it is advisable to consult the application engineering department of Schaeffler Group Industrial.

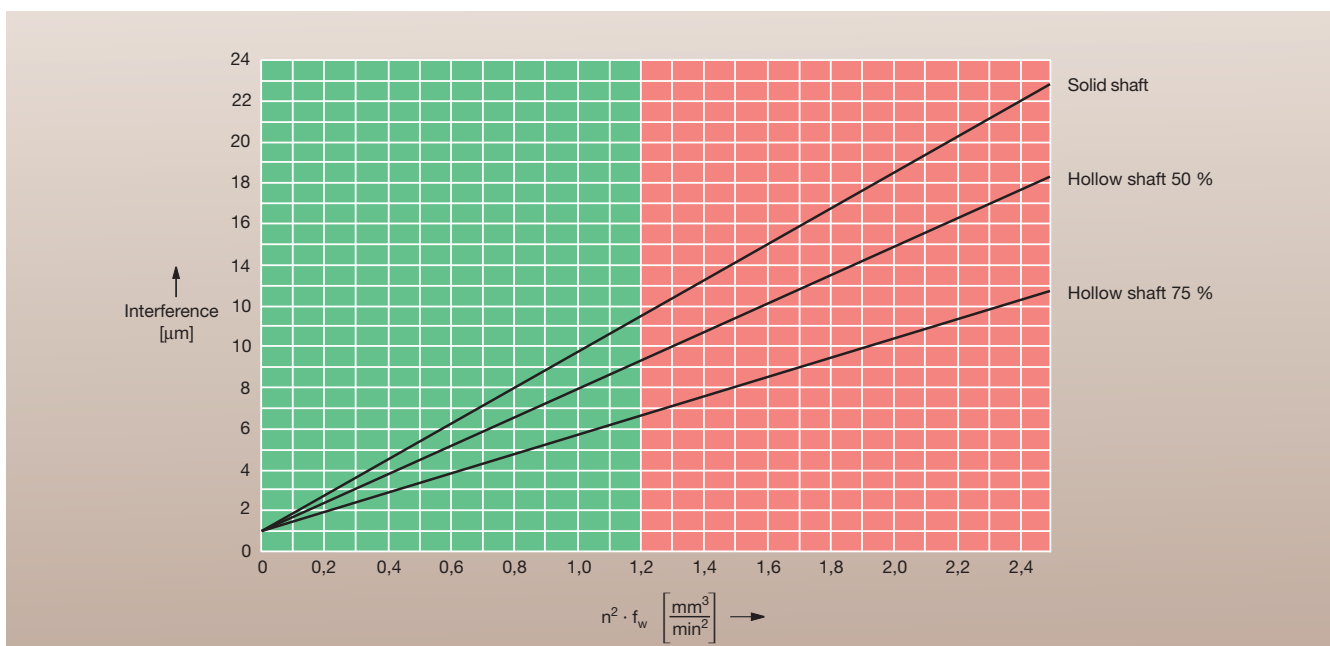

11: Speed-dependent determination of interference shaft/inner ring

Engineering

Speed dependent fits

The value f_w can be obtained from Diagram 12 (for bearings of type B, HCB and XCB) and Diagram 13 (for bearings of type HS, HC and XC). If value $n^2 \cdot f_w < 1,2$, the resulting shaft dimension is as follows:

Example:

HCS71914E.T.P4S.UL
Speed $n = 16\,000 \text{ min}^{-1}$

Actual dimension of inner ring:
70 mm – 3 μm = 69,997 mm.
(The deviation from the nominal dimension is indicated on the bearing ring).
Hollow shaft of 35 mm bore
(50 % of diameter)
 $f_w = 4,30 \cdot 10^{-9}$ (according to Diagram 13 for bearing types HS, HC and XC)
 $n^2 \cdot f_w = 1,1$

The value 1,1 and curve “Hollow shaft 50%” (Diagram 11) result in a required interference of 9 μm . So the actual dimension of the shaft must be 70,006 mm to ensure that the inner ring will still be tightly located on the shaft at a speed of $n = 16\,000 \text{ min}^{-1}$.

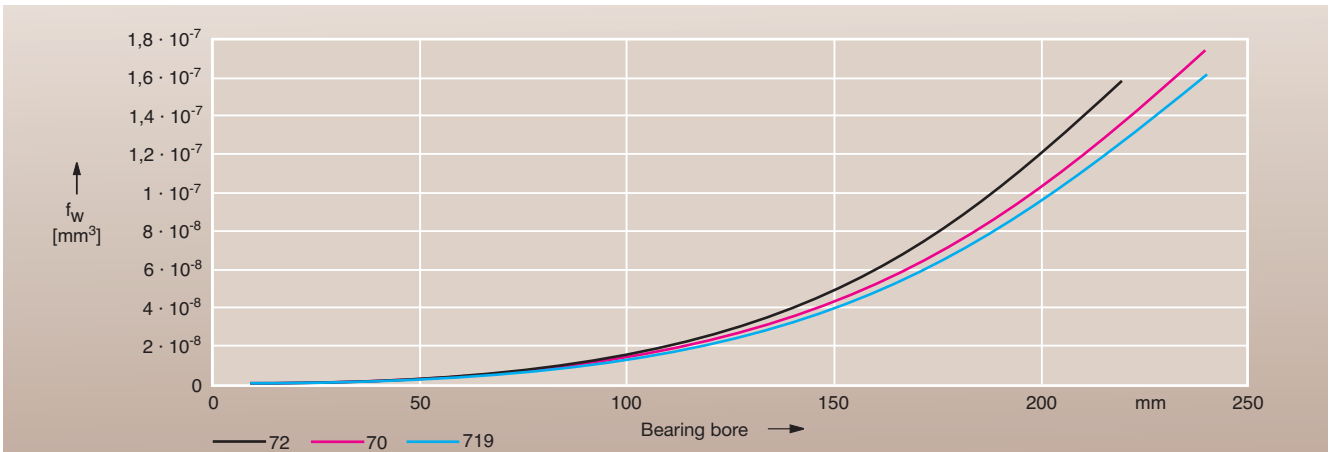

12: Factor f_w for the speed-dependent determination of the inner ring/shaft fit for bearing series B, HCB, XCB

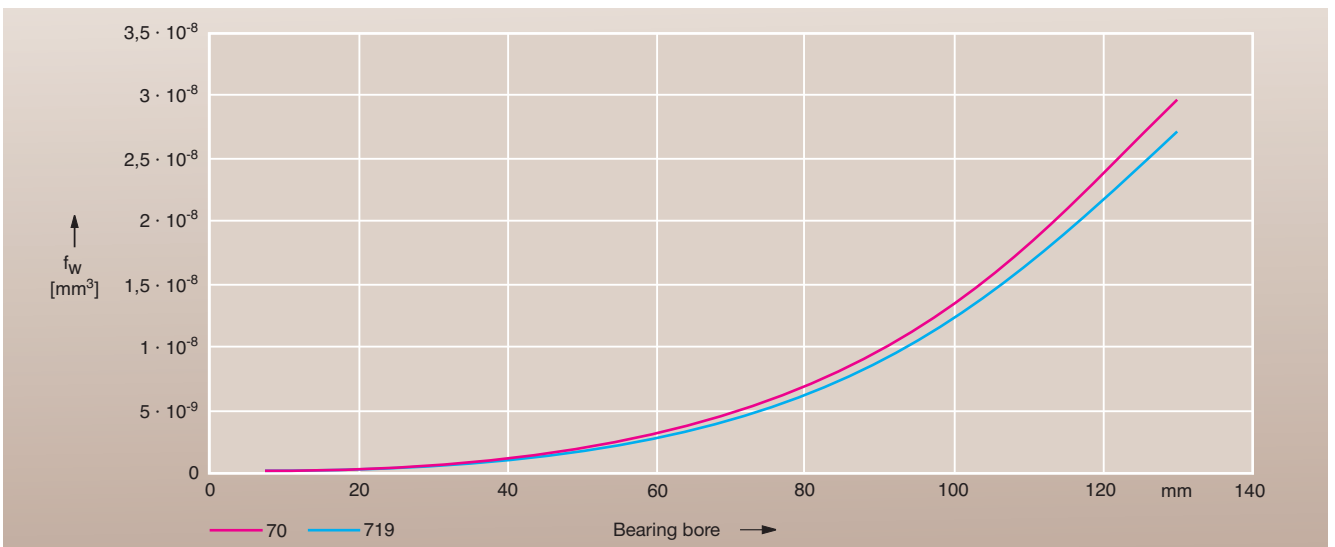

13: Factor f_w for the speed-dependent determination of the inner ring/shaft fit for bearing series B, HC, XC

Engineering

Speeds

Speeds

















The speeds attainable by a specific bearing arrangement depend on the overall energy balance of the system. The number of bearings, their position, internal stress (clearance or preload), external stress and lubrication on the one hand as well as the heat dissipation conditions on the other hand are the decisive factors here. The attainable speed figures in the bearing tables are guide values that may be higher or lower, depending on the mentioned conditions.

Spindle bearings

The attainable speeds stated in the bearing tables are an indication of the speed-ability of elastically preloaded single bearings. These speeds are not attained by rigidly preloaded bearings, bearing pairs or groups. The reduction factors to be assumed here are shown in Table 14.

Cylindrical roller bearing

For cylindrical roller bearings the attainable speed is determined through the adjusted radial clearance. See Table 8, page 210 in section Mounting guidelines for corresponding indications.

Bearing Arrangement	Factor f_r Bearing preload		
	L	M	H
Large bearing distance			
			
	0,85	0,75	0,5
			
	0,8	0,7	0,5
			
	0,75	0,65	0,45
Small bearing distance			
			
	0,75	0,6	0,35
			
	0,65	0,5	0,3
			
	0,65	0,5	0,3
			
	0,72	0,57	0,37
			
	0,54	0,4	0,37

14: Speed reduction ($n^* \cdot f_r$) for spindle bearing sets

Engineering

Deflection and rigidity

Deflection and rigidity

Bearing set rigidity is dependant upon bearing arrangement and preloading. Rigidity of the entire machine tool system is, besides from bearing rigidity, substantially determined by shaft and housing rigidity as well.

Axial rigidity c_a

Axial rigidity is defined as a quotient from axial load and axial displacement.

$$c_a = F_a / \delta_a$$



c_a = axial rigidity [N/ μ m]

F_a = axial load [N]

δ_a = axial deflection [μ m]

Unloading force K_{aE}

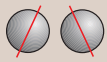
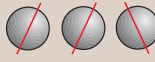
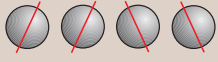
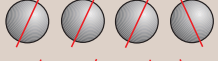
If a bearing set is loaded by a centrally acting axial load, then the bearings are loaded as a result of deflection and their contact angle is set against the load direction while the opposing fitted bearing is simultaneously relieved. Unloading force K_{aE} is defined as the force that unloads bearings by relieving the bearing set of the centrally acting axial load.

Bearing Arrangement	Suffix	c_a N/ μ m	K_{aE} $\alpha = 15^\circ$ and $\alpha = 25^\circ$ N
	DB	$c_a^{1)}$	$3 \cdot F_V$
	TBT	$1,64 \cdot c_a$	$6 \cdot F_V$
	QBC	$2 \cdot c_a$	$6 \cdot F_V$
	QBT	$2,24 \cdot c_a$	$9 \cdot F_V$
	PBC	$2,64 \cdot c_a$	$9 \cdot F_V$

K_{aE} = Unloading force F_V = Preloading force ¹⁾ Bearing tables

15: Axial rigidity c_a of a bearing set at a centrally acting axial load

Engineering

Deflection and rigidity

Spindle bearings

The bearing set deflection is close to being linear up to the loading force that unloads a bearing. The axial rigidity values stated in the bearing tables c_a apply to bearing pairs in back-to-back or face-to-face arrangement. Radial rigidity c_r can be estimated from the axial rigidity by means of a factor.



$$c_r \approx 6 \cdot c_a \text{ for } \alpha = 15^\circ$$

$$c_r \approx 2 \cdot c_a \text{ for } \alpha = 25^\circ$$

Sets of more than two bearings feature increased rigidity values and loading force. Table 15 shows approximate values for axial rigidity and loading force on centrally acting axial load. The radial rigidity for such sets with a radial load acting on the center of the set is approximately calculated from radial rigidity of bearing pairs according to Table 16.

Double Direction Angular Contact Thrust Ball Bearings of series 2344..

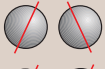
The axial rigidity values stated in the bearing tables c_a are valid up to an axial load corresponding to 2,2 % of the dynamic load rating C .

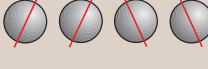
Bearing Arrangement	Suffix	c_r N/ μ m
	DB	c_r
	TBT	$1,36 \cdot c_r$
	QBC	$2 \cdot c_r$

16: Radial rigidity c_r of a bearing set. The radial load acting on the centre of the set.

Engineering

Bearing monitoring

Bearing monitoring

All factors that react to changes in bearings or any kind of changes in operating conditions are regarded as measurement values for bearing monitoring. These can be forces, as well as oscillations, temperatures, drive power etc. During bearing monitoring, it must always be ensured that the absolute value of the measurement value has little significance. It is much more important to monitor changes that may occur. For example, an absolute temperature of 40 °C does not damage rolling bearings. If the

steady-state temperature increases from 35 °C to 40 °C in a short period of time, then this may well be a sign of incipient bearing damage. It should be taken into account when choosing a monitoring method that continuous damage improvement over a longer period of time can only be expected at low and medium speeds. In these cases, periodical monitoring would make sense. In the area of high and extreme speeds, spontaneous failure can also be included in risk assessment, so that damage is limited and worked exclusively with continuous monitoring.

One-time monitoring is used exclusively for quality assurance of newly manufactured or repaired spindles. For example, slow-down time or natural frequency measurement is considered here. Faults in pre-loading can be quickly and positively determined during both of these processes. Temperature, vibration velocity and vibration acceleration measurements are prevalent procedures used for quality assurance. These are to only be used for comparable procedures, like slow-down time measurement.

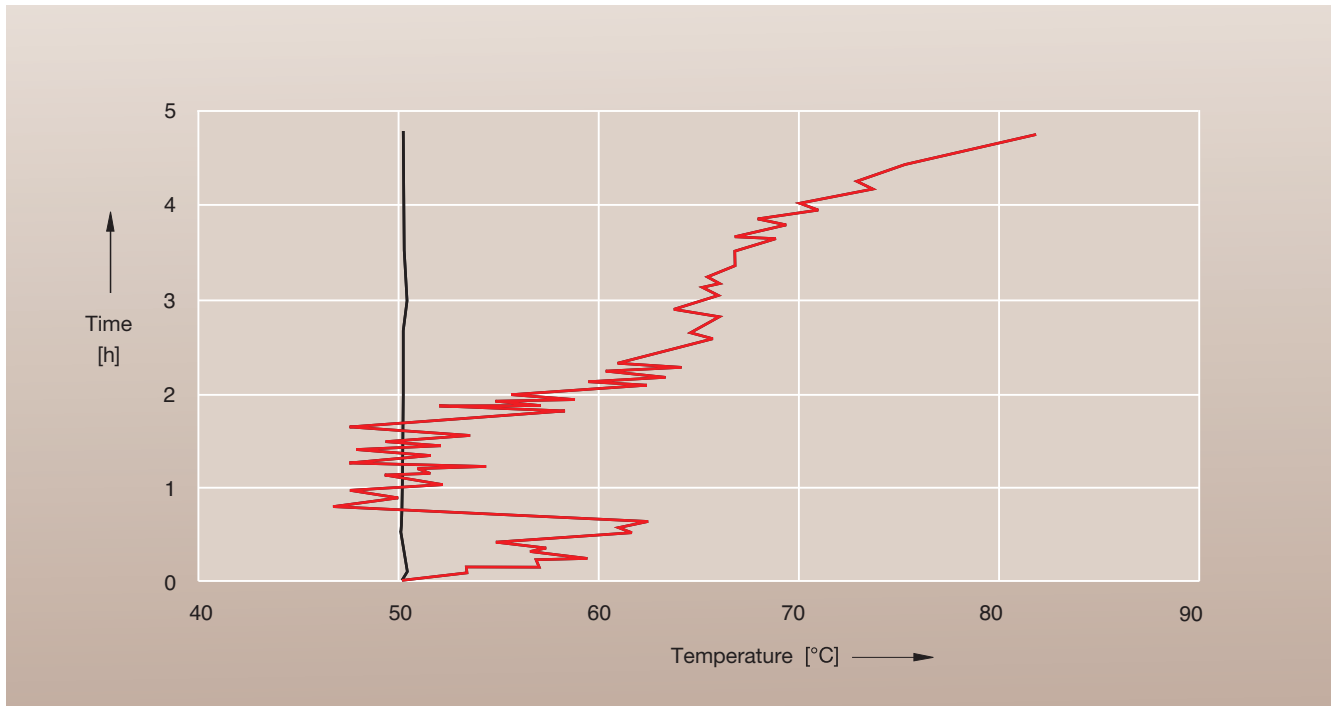

17: Bearing temperature patterns
black = normal
red = end of grease service life

Engineering

Bearing monitoring

Temperature monitoring

In many cases, temperature is very significant to the operational behavior of bearings. Normally, for greased bearings deterioration or imminent failure can be determined in time. There is a relatively stable pattern of typical temperature behavior for preload changes which result in defective functioning of floating bearings. Normally, temperature is measured in stationary rings, this is generally the outer ring. Time-based temperature change is the basis for the assessment.

The following guidelines should be followed for dependable temperature measurement:

- measure as close to bearings as possible
- measure continually if possible
- avoid bearing deformation from measuring sensor

A normal bearing temperature pattern is stable. However, if the grease service life ends, then the temperature will become unstable and start rising and falling.

Intervention is necessary, at the latest, when a loss of performance becomes apparent.

Bearing arrangement design and application examples

Preload · Rigidity

Bearing arrangement design and application examples

In practice, a large number of various spindle bearings is used. The selection of the spindle bearing type and arrangement is generally determined by the specific end use they will see; turning, milling, grinding etc. However, both operation conditions and economic considerations also play a significant role in the final selection and specification.

In operation, bearings typically must run preloaded or at least clearance free, in order to attain high precision requirements (P4 and better). The lowest possible operating temperatures are required for highest speeds (with grease lubrication up to $n \cdot d_m = 2 \cdot 10^6$ mm/min. and with oil lubrication up to $3,1 \cdot 10^6$ mm/min.).

This requires the use of super precision bearings and correspondingly precise mating parts.

The following information should help in the search for a selection of optimal uses for bearings and bearing arrangements. The following aspects are covered:

- Preload
- Rigidity
- Contact angle
- Ball size and material
- Distance between the bearings
- Sealing
- Steps for bearing design
- Bearing arrangement comparison
- Bearing examples.

Preload

Rigidly preloaded bearings react sensitively to temperature changes between the shaft and housing, especially if they have a short distance between the bearings. Preloading within the bearing set could significantly increase or even cause the bearings to lose all internal clearance if the axial sliding fit fails. Radial stress can occur, especially in spindle bearings with a 15° contact angle. This applies to cylindrical roller bearings and spindle bearing pairs with a sliding fit as well. In comparison, bearings with elastic preload, bearing sets with a wider distance between bearings and bearings with 25° contact angle are not as susceptible. Normally, bearings with ceramic rolling elements have lower operating temperatures. In a rigid system preloading here does not increase with ΔT as it does with steel balls.

Speed reducing factors (see Table 2) need to be used with rigidly preloaded bearings.

In elastically adjusted (by springs or hydraulically) bearings speeds are attained in accordance to the bearing tables due to reduced thermal sensitivity. The chosen preloading force is at least equivalent to medium bearing preload M (see Bearing tables).

Rigidity

The bearing system rigidity is affected by the shaft diameter, number of bearings, bearing size, preloading and contact angle. Bearings with a 15° contact angle have only 45% of the axial rigidity of bearings with a 25° contact angle, whereas the advantage in radial rigidity is only around 10%. If the whole spindle bearing/cantilever system is considered, then the radial rigidity of a bearing arrangement with 25° bearings, due to wider support basis, is normally better than one with 15° bearings.

The rigidity of a rigidly preloaded bearing arrangement increases, in comparison to catalog data, during the assembly because of the fitting influence. During operation, it normally increases through ring expansion from centrifugal force at high speeds and the thermal expansion of shaft and inner ring.

Bearing arrangement design and application examples

Selection of suitable bearing contact angles · Selection of bearings in terms of ball size and materials

Selection of suitable bearing contact angles

Both available contact angles have different preferences and application areas (see Table 1).

Selection of bearings in terms of ball size and materials

All spindle bearings that have a “B” in their type description are filled with large balls and the rest have small balls.

Bearings with large balls exhibit higher load carrying capacity and are thus better suited for higher loads than those with small balls. In contrast, the latter is preferred over this when high speeds are required.

Bearings with ceramic rolling elements have an additional speed advantage over this (see section Bearing tables, spindle bearings). X-life ultra bearings are always made with Cronidur 30 rings and ceramic balls. Small ball bearings of this model type begin with an XC type description. Large ball bearings begin with type description XCB.

The following comparison of the specifications and performance data of spindle bearings is helpful for proper bearing selection.

Contact Angle	15°	25°
Preferences	Radial rigidity Radial load carrying capacity Higher speed with small ΔT	Axial rigidity Radial system rigidity Axial load carrying capacity Combined radial and axial load capacity High ΔT between IR and AR
Applications	Grinding machines Super finishing machines Belt side of bearing arrangement	Turning machinery Milling machines Drills Machining centres Motor spindles

1: Bearing contact angle selection criteria

Ball Size/ Ball material Bearing type	Load	Speeds	Service Life
Size/Steel B...	High	Medium	Good
Small/Steel HS..	Middle	High	Better
Size/Ceramic HCB..	Middle	High	Much better
Small/Ceramic HC..	Low	Highest	Best
X-life ultra bearings XC..., XCB..	Premium	Premium	Premium

2: Performance comparison of different ball size and material

Bearing arrangement design and application examples

Choice of optimal space between bearings · Sealing

Choice of optimal distance between bearings

It is recommended, when constructionally possible, to select a thermally neutral space between bearings for rigidly preloaded bearing arrangements, with which the effects of radial and axial thermal expansion of the shaft is compensated with respect to preloading influence.

This thermally optimal spacing between bearings, L , corresponds to about three-times the size of shaft diameter d for spindle bearings with a 25° contact angle; for bearings with 15° L is approx. five-times d , however, here axial thermal expansion is often too slow to be effective due to the long space between bearings and this makes the advantage questionable. Therefore, such a design is seldom found in practice.

Seal

Main spindle bearings have to be effectively sealed, especially at the spindle nose. A non-contact labyrinth seal with a protective shroud, tight radial gap (according to $h8/C9$), wide axial gap (gap width ≥ 3 mm) and waste bore, is necessary and has to be effectively sealed from cutting fluid, swarf or dust during rotation and downtime. Sealed, greased bearings support the labyrinth effect and prevent air flow through the bearing arrangement.

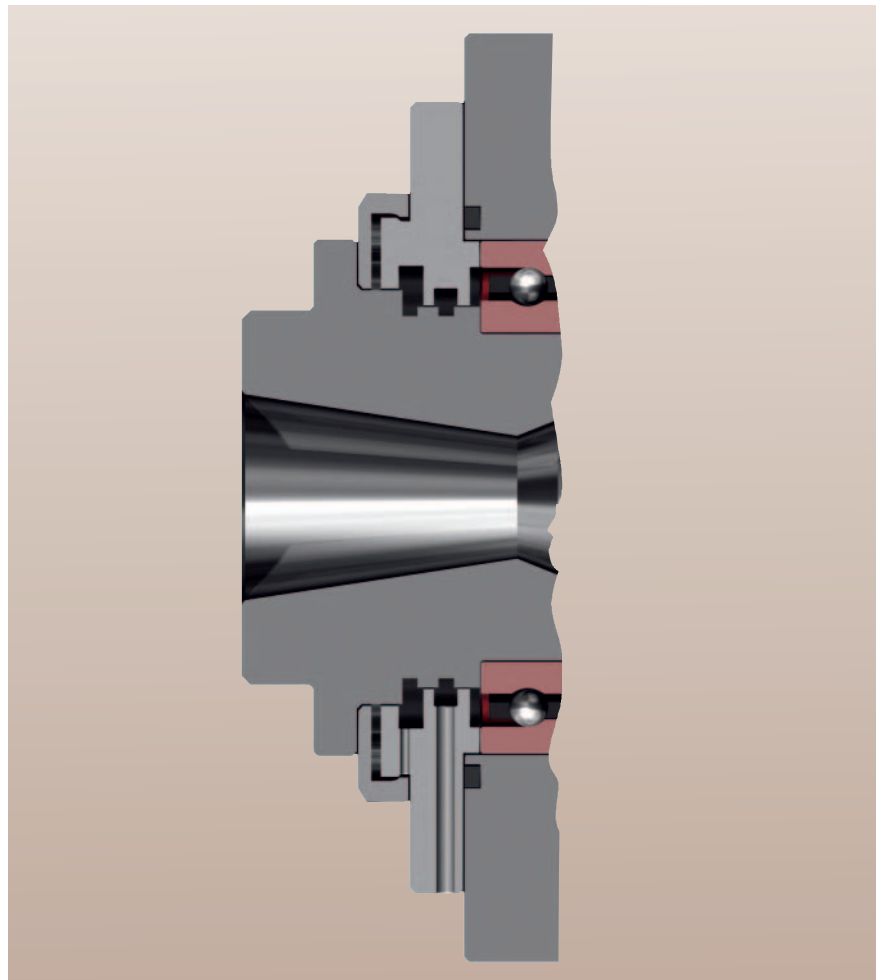

3: Example of a labyrinth seal on a horizontal spindle

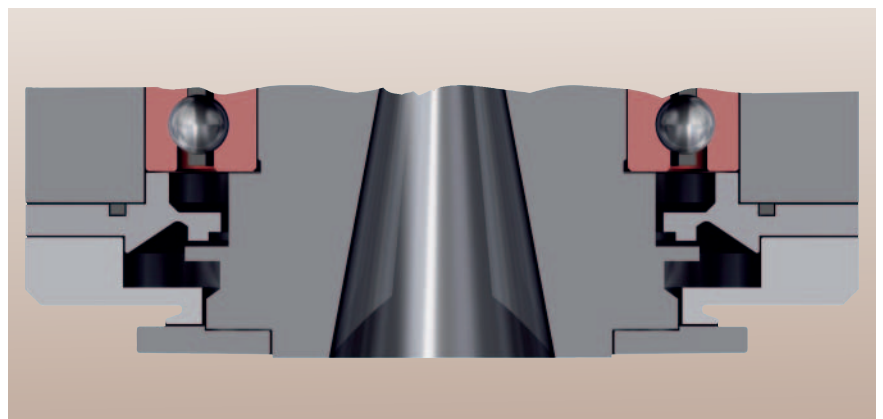

4: Example of a labyrinth seal on a vertical spindle

Bearing arrangement design and application examples

Steps for bearing arrangement design

Steps for bearing arrangement design

To design a spindle bearing arrangement, the following steps should be carried out:

1. Establish operating conditions (speed, force, duration, spacing and diameter, temperature, environmental influences)
2. Select bearing arrangement on the basis of use and requirements (see Table 6)
3. Determine lubrication (see section Lubrication, page 176 ff.)
4. Select bearing type and size on the basis of speed (see section Speed, page 189), installation space and lubrication
5. Check grease service life (see Lubrication, Table 5, page 180)
6. Calculate load distribution on the bearing
7. Check bearing arrangement for infinite service life (see section Life Calculation)

If a calculation program is available, the following steps can be carried out:

8. Calculate bearing kinematics (spin/roll ratio, ball excursions) and contact pressure (P_0) and compare to design limits (see Table 5)
9. Assess life, taking into account lubrication and cleanliness
10. Calculate shaft, deflections and rigidity
11. Recalculate natural frequencies and/or critical speeds
12. Optimize bearing arrangement

Schaeffler KG offers a service for the aforementioned calculations upon request. To ensure the complete information is provided, completion of the form, as shown on page 203, is advisable. This form is also available for download at www.fag.com.

Spin/roll ratio	maximum 0,5
Maximum ball excursions	dependant on inner design of the bearing
Hertzian contact pressure	Limits for infinite fatigue life: Point contact: with 100Cr6: 2 000 MPa with Cronidur 30: 2 500 MPa Line contact: with 100Cr6: 1 500 MPa with Cronidur 30: 1 900 MPa

5: Design limits

Bearing arrangement design and application examples

Bearing arrangement comparison

Bearing arrangement comparison

Bearing arrangement		Typical application	Speed suitability %	System rigidity %		Load carrying capacity %		Temperature patterns Assessment	
front	back			Axial	Radial	Axial	Radial	Operational Temperature	Sensibility
==≥	==	Universal	50	100	100	60	100	★☆☆☆☆☆☆	★☆☆☆☆☆☆
<<>	==	Grinding	72	65	100	75	50	★★☆☆☆☆☆☆	★★☆☆☆☆☆☆
<<>	==	Turning	65	44	86	75	47	★☆☆☆☆☆☆	★★☆☆☆☆☆☆
<<>	<>	Turning, Grinding	65	44	84	75	44	★★☆☆☆☆☆☆	★☆☆☆☆☆☆
<>	=	Wood, Motor	75	32	79	35	42	★★★☆☆☆☆	★★★☆☆☆☆
<>	<>	Drilling, Motor	75	32	77	35	40	★★★☆☆☆☆	★★★☆☆☆☆
<>	◌	Motor	75	32	59	35	38	★★★☆☆☆☆	★★★☆☆☆☆
<	>	Milling, Drilling	85	30	62	35	22	★★★★☆☆☆	★★★★☆☆☆
<<	>>	Milling, Drilling, Universal	80	61	95	75	44	★★★★☆☆☆	★★★★☆☆☆
<<<	>>	Milling, Drilling, Universal	75	76	98	100	46	★★★★☆☆☆	★★★★☆☆☆
<	≈>	Motor	100	23	60	30	27	★★★★☆☆☆	★★★★☆☆☆
<<	≈>>	Motor	100	46	92	60	52	★★★★☆☆☆	★★★★☆☆☆
<≈>	≈>	Motor	100	25	89	25	60	★★★★☆☆☆	★★★★☆☆☆
<≈>	◌	Motor	100	23	58	30	42	★★★★☆☆☆	★★★★☆☆☆
<≈>	=	Motor	80	23	82	30	46	★★★★☆☆☆	★★★★☆☆☆
<<≈>	≈>	Motor	100	46	93	50	65	★★★★☆☆☆	★★★★☆☆☆
<<≈>>	≈>>	Motor	100	48	98	48	65	★★★★☆☆☆	★★★★☆☆☆

Key to symbols: 100 = optimal, ★☆☆☆☆☆☆ very unfavorable, ★★★★★☆☆ very good
 < spindle bearing, = single and == double row cylindrical roller bearings, ≥ 2344.., ◌ FD-bearing, ≈ spring
 The data is for guidance purposes. The data was generated, with respect to spindles with a d = 70 mm shaft diameter, a space between bearing L = 3d and a cantilever A = L/2

6: Bearing arrangements: Application and performance data comparison

Bearing arrangement design and application examples

Bearing arrangement examples

Bearing arrangement examples

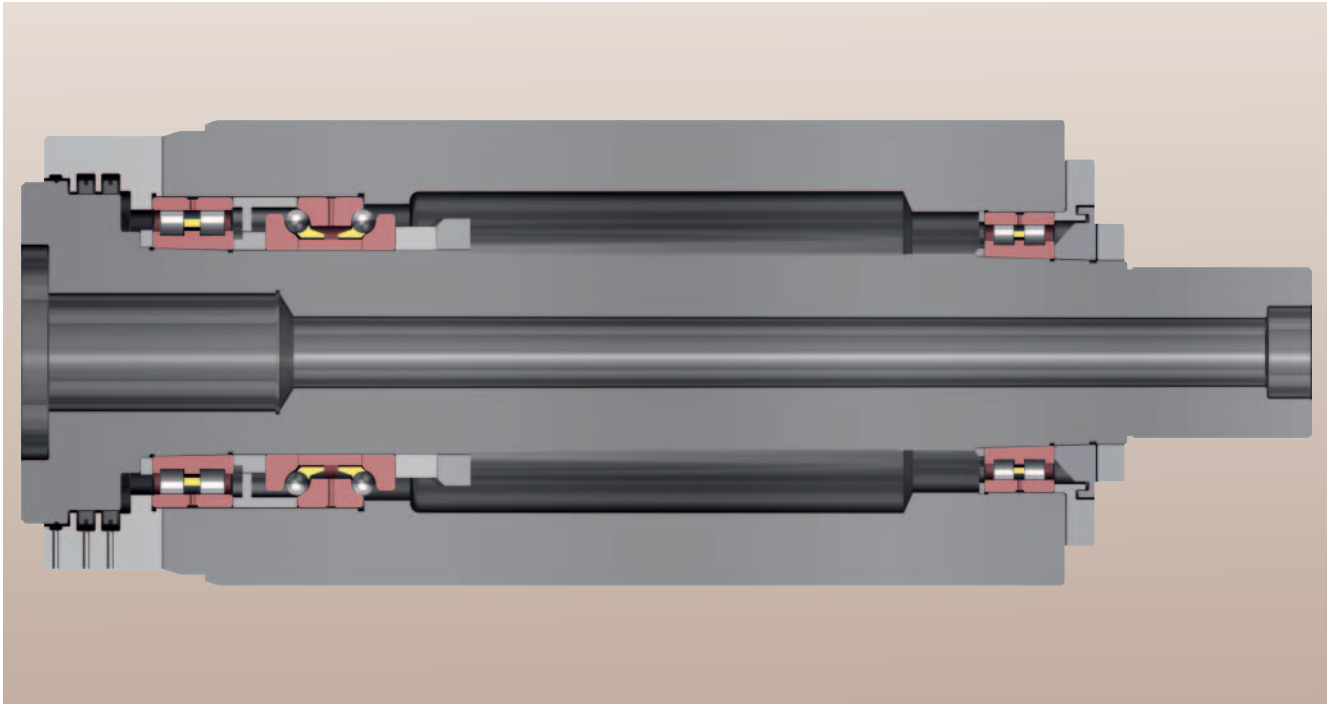

7: Milling spindle, machining centre, high load carrying capacity

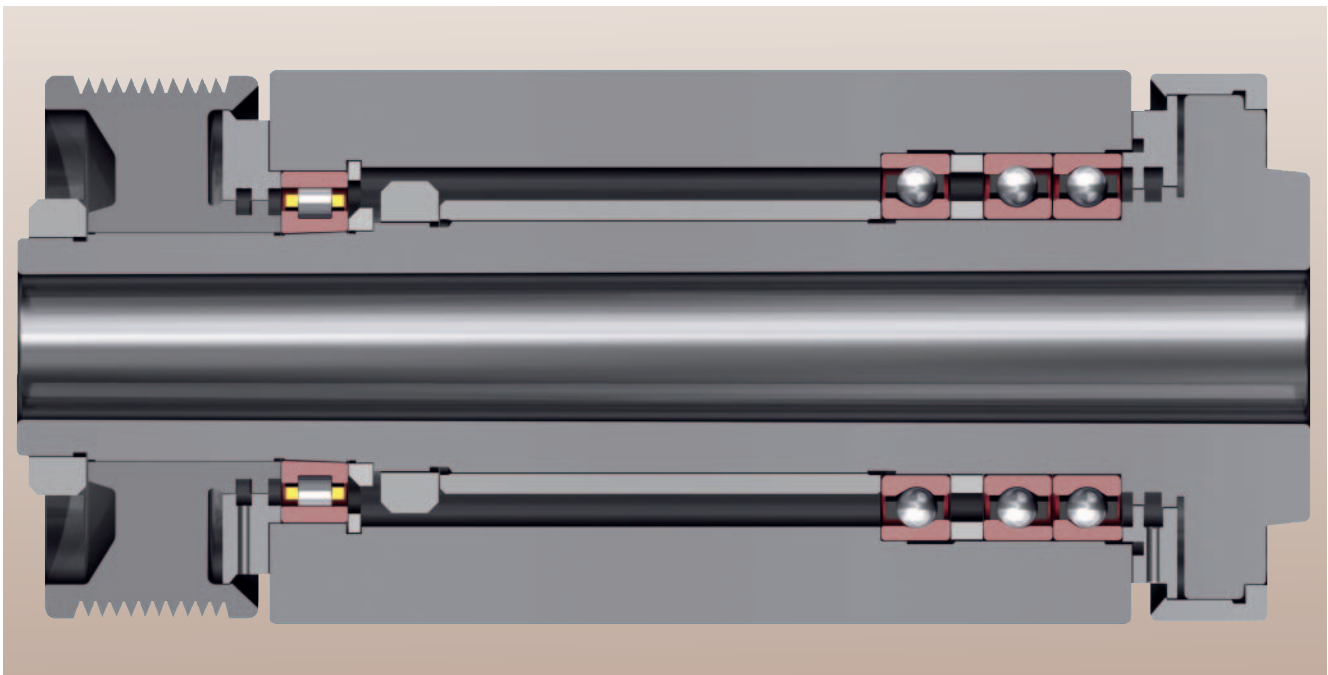

8: Turning spindle

Design

Bearing arrangement design and application examples

Bearing arrangement examples

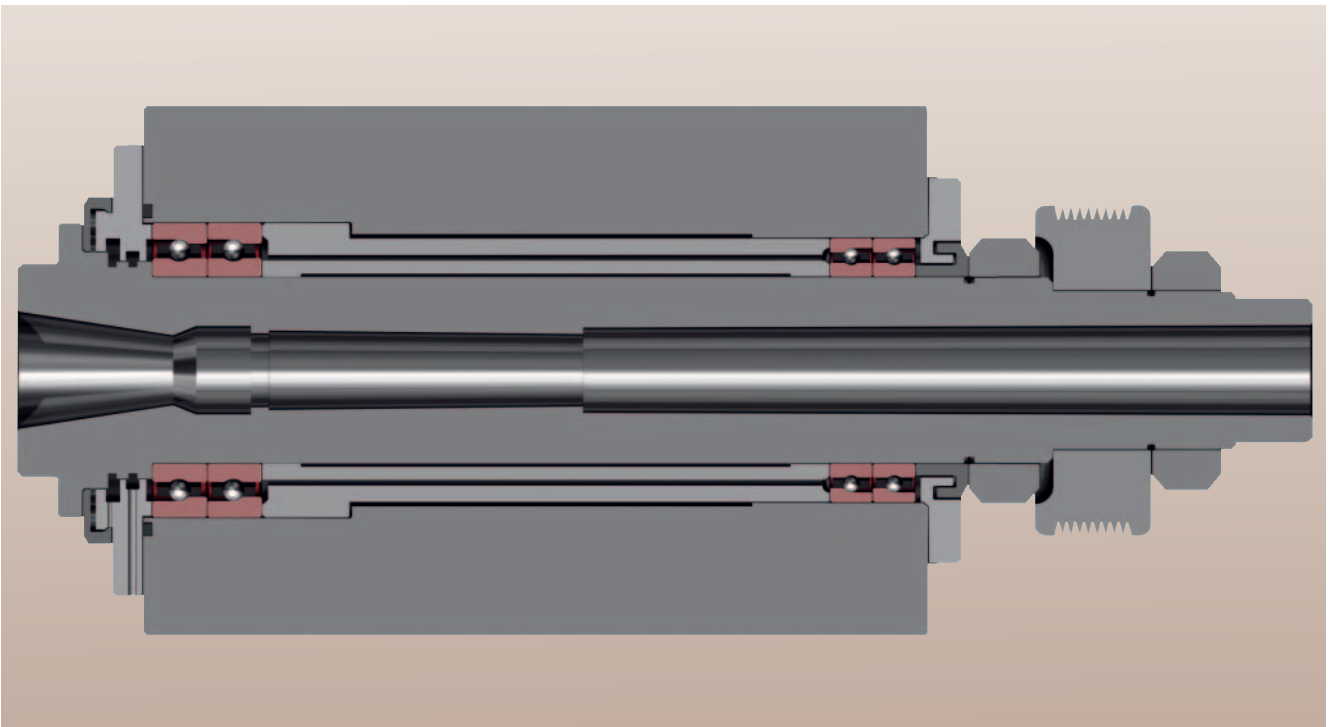

9: Machining centre, milling spindle for higher speed

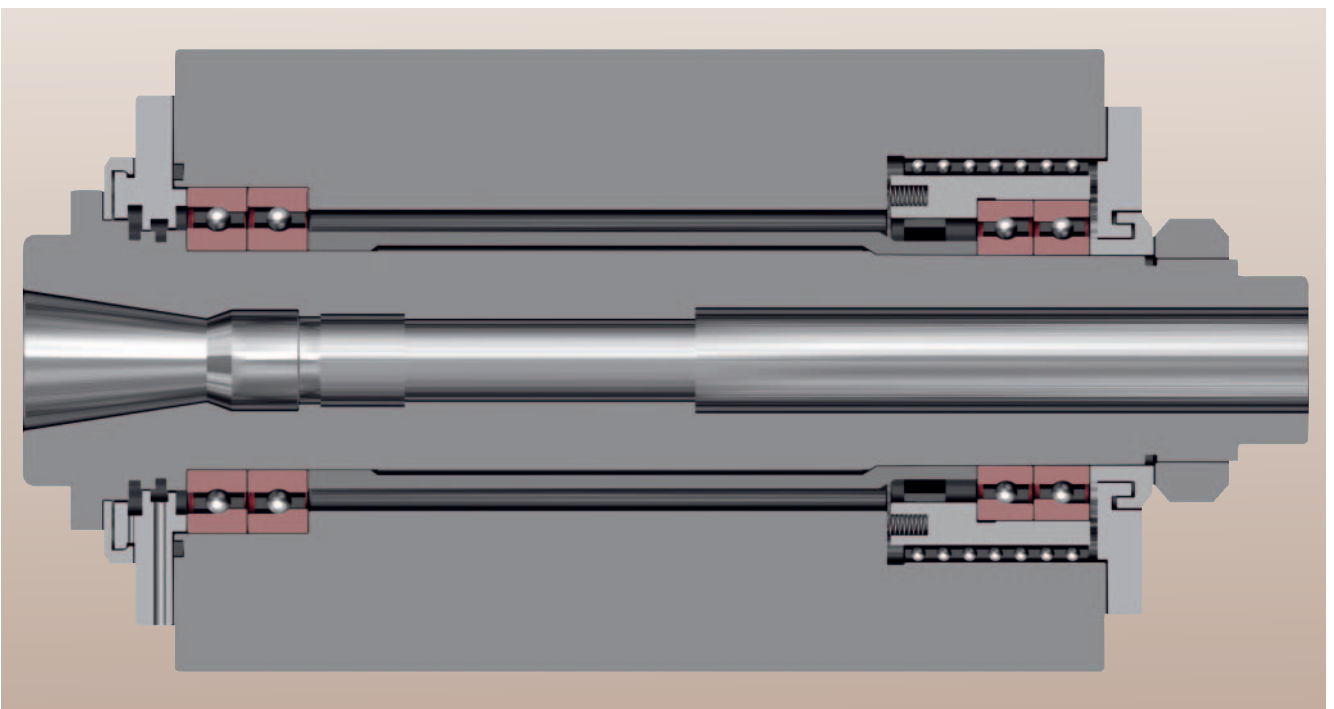

10: Machining centre for highest speeds

Bearing arrangement design and application examples

Bearing arrangement examples

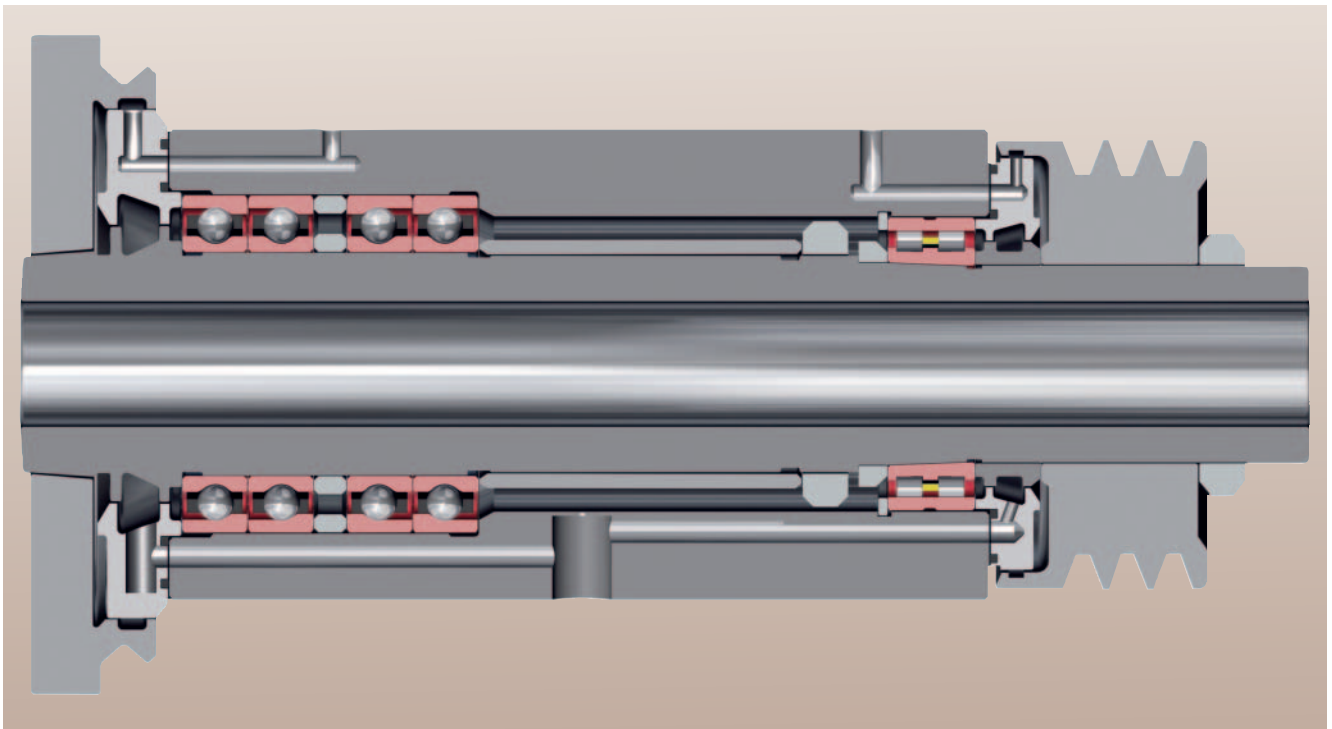

11: Grinding spindle

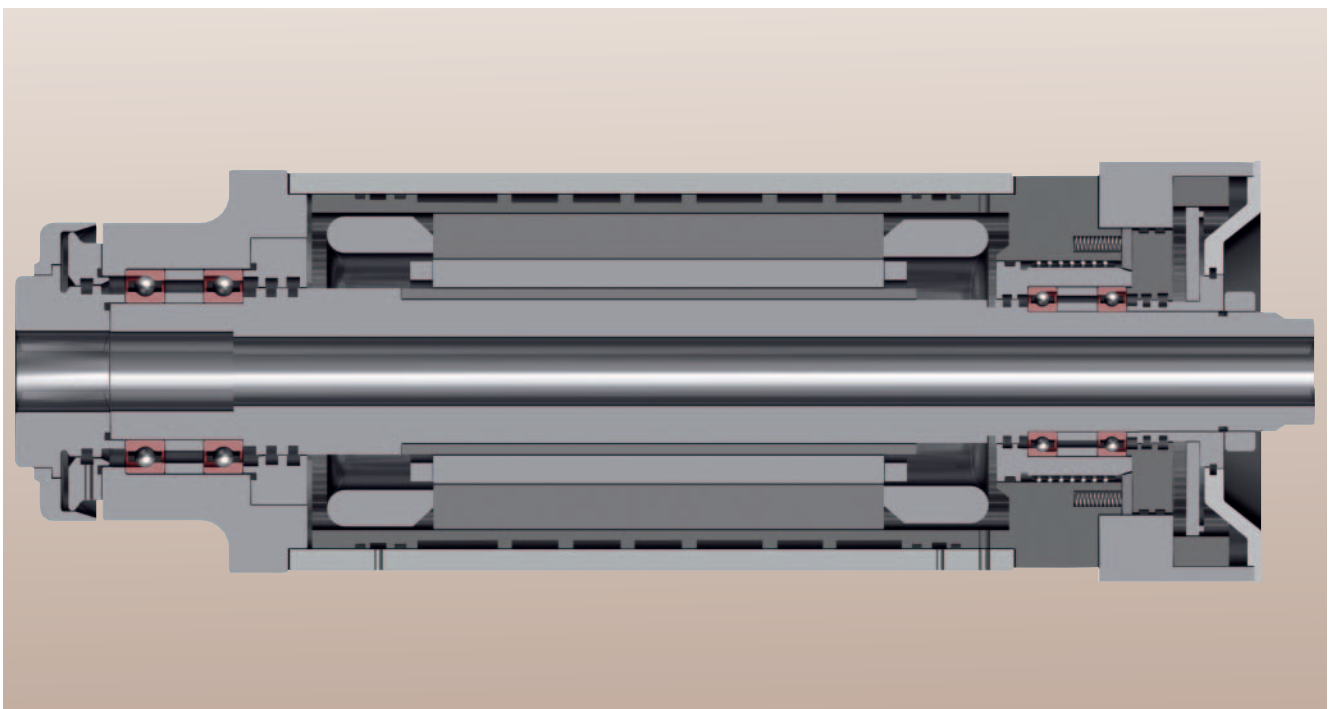

12: High-frequency motor spindle

Design

Bearing arrangement design and application examples

Bearing arrangement examples

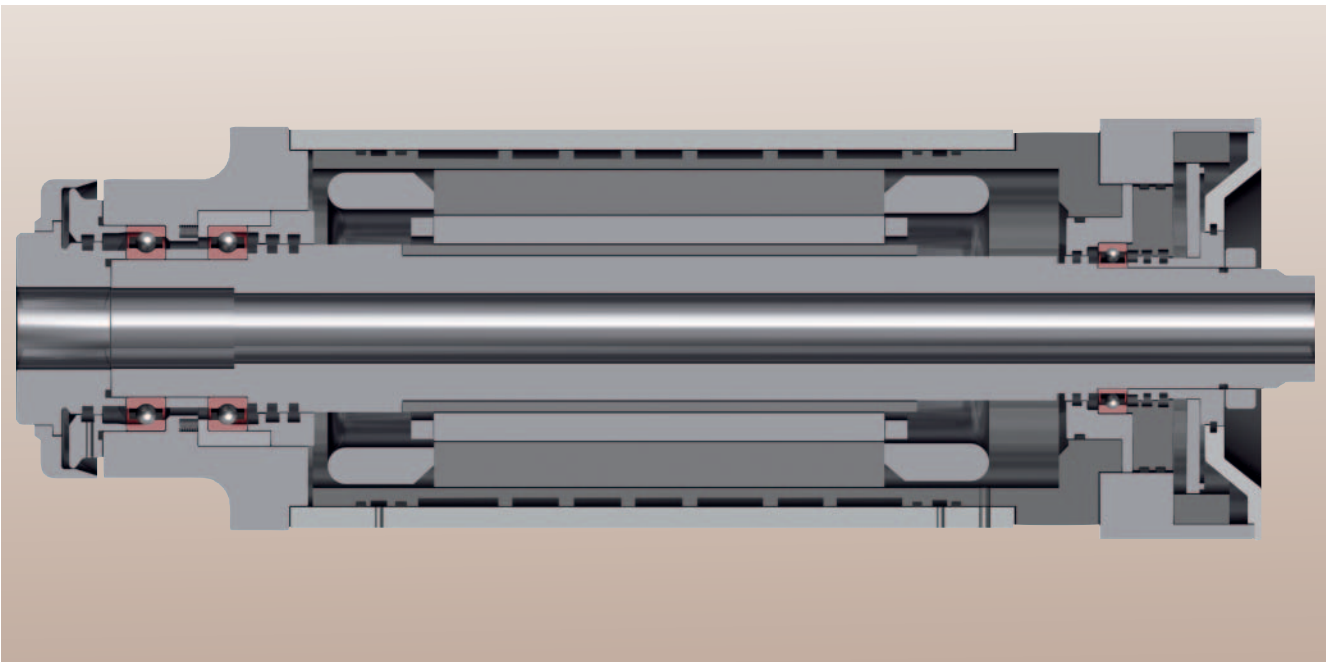

13: High frequency motor spindle with Floating Displacement Bearing (FD.)

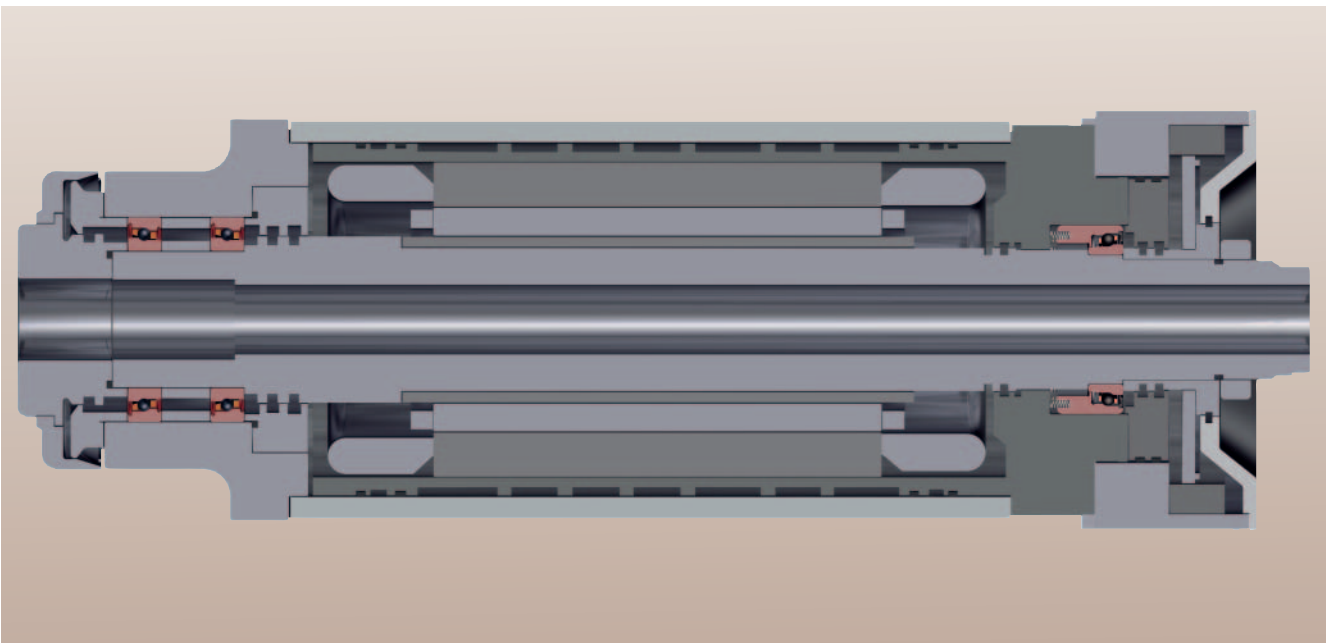

14: High frequency motor spindle with spring preloaded floating bearing unit (SPP.)

15: Form: Request for bearing arrangement calculation

LH-Nr.:

Inquiry for Data for Bearing Calculation (Drawing included: yes / no)

<p>Bearing Arrangement (Sketch, e.g. << >):</p> <div style="border: 1px dashed black; height: 40px; margin: 5px 0;"></div> <p>Rigid Preload <input type="checkbox"/> Spring Preload <input type="checkbox"/></p> <p>Spring Force: _____</p>	<p>Application: _____</p> <p>Drive: _____</p> <p>Shaft Position: vertical <input type="checkbox"/> horizontal <input type="checkbox"/> tilting <input type="checkbox"/></p>
--	---

<p>Bearing Type(s) Working Side (Front)</p> <p>_____</p>	<p>Bearing Type(s) Drive Side (Rear)</p> <p>_____</p>
--	---

Max. Speed [rpm]: _____	Lubrication: _____	Nom.-Viscosity: cSt _____
-------------------------	--------------------	---------------------------

Load Cycles:							
Fr [kN]	Fa [kN]	Ft [kN]	Speed n [rpm]	Time Share [%]	Tool Diameter [mm]	Cantil. arm a [mm]	Belt Force/ F _R [kN]

<p>Specific Influences / Operating Conditions:</p>	<p><u>Assumptions:</u> Bearing Temperature. Front/Back: T = / C, ΔT (IR/AR) f/b = / K, Interference (Shaft/IR) f/b: / μm</p>
--	---

Bearing Distance l = _____ mm, Belt Distance b = _____ mm, a = _____



Questions: (Please enclose a drawing if possible!)

Name: _____ Date: _____

This form is available for download under www.fag.com.

Mounting guidelines

Handling of Super Precision Bearings

Handling of Super Precision Bearings

FAG super precision bearings are manufactured under the cleanest conditions possible, intensively inspected and protected by high-quality packaging. In order to preserve the full performance capacity of the bearings, they have to be handled very carefully during mounting. A separate, clean mounting room offers the best conditions here.

Preparation of parts

Only approved parts should be used for mounting. Depending on the component, the approval procedure consists of a dimensional inspection, optical inspection or an additional pre-balancing procedure.

Matching of parts

Fitting has a decisive influence on bearing function. Therefore, it sometimes makes sense to match bearings to the spindle or housing diameter. In the case of spindle bearings, the bore and housing tolerances are divided into groups, the mean tolerance of which is indicated on the packaging and the bearing itself. The spindle bearing width as a deviation of the nominal dimension is also indicated on the bearing (see page 19).



1: Spindle assembly

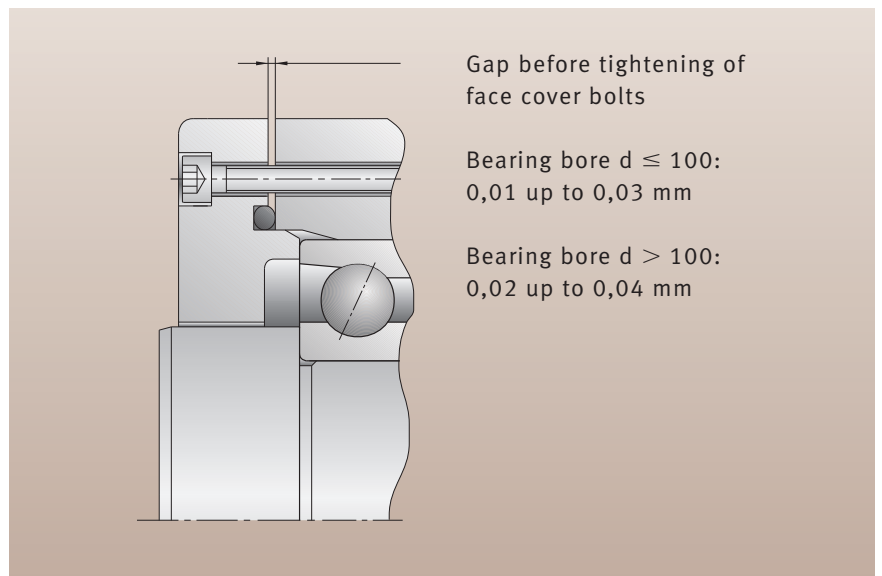

Gap before tightening of face cover bolts

Bearing bore $d \leq 100$:
0,01 up to 0,03 mm

Bearing bore $d > 100$:
0,02 up to 0,04 mm

2: Recommended adjustment of face covers

Mounting guidelines

Handling of Super Precision Bearings

Matching procedures

In order to obtain optimum performance or achieve an accurate position of the spindle in relation to the housing, it may be necessary to make special adjustments. This applies for instance to the cover that serves for axially clamping the bearings in the housing. Prior to clamping, an adequate gap should be available (see Figure 2). An adjustment of spacer rings is advisable for high-speed spindles, in order to compensate for the influence of fit and ring expansion on preload.

Lubricating greases

FAG super precision bearings are preserved in such a way that the washing of bearings prior to greasing is not required. Grease filling can be obtained from Table 4 on page 179. Greasing should only occur under the cleanest conditions. Adjustments of grease amount places high demands on the application of greasing and measuring equipment. It is ideal to have bearings that are already greased and sealed by Schaeffler Group.

Assembly

When mounting the bearing onto the shaft or inside the housing you must not load through the rolling elements.

Components that have to be mounted with tight fits (interference fits) should be heated prior to mounting. This can be done in a simple, quick and clean way by using inductive heating devices. (see Figure 3).

Values for the axial clamping of bearings on the shaft by means of a precision nut are indicated in Tables 4 and 5. To rule out or reduce setting effects, it is recommended to initially tighten

the nut with three times the indicated torque, loosen it again and then tighten it finally with the nominal torque.

Test run and grease distribution

With grease lubricated bearings, a grease distribution run must be performed on the bearings before a spindle test run. Data about grease amount and grease distribution run can be found on the general guide in Appendix (see page 230).

This guide is also available at www.fag.com and can be ordered in laminated form from Schaeffler KG.



3: Warming a spindle bearing using an inductive heating device

Mounting guidelines

Handling of Super Precision Bearings

Bore/ Bore reference number	Axial clamping force				Tightening torque				Thread
	718	719	70	72	718	719	70	72	
	kN				Nm				
6			1,49				1,52		M6×0,5
7			1,51				1,70		M7×0,5
8			1,53				1,89		M8×0,75
9			1,55				2,09		M9×0,75
00	0,81	0,66	1,58	1,36	1,18	0,96	2,30	1,99	M10×0,75
01	0,85	0,71	1,64	1,45	1,42	1,19	2,75	2,43	M12×1
02	0,92	0,79	1,75	1,60	1,85	1,60	3,52	3,23	M15×1
03	0,97	0,86	1,84	1,73	2,17	1,93	4,11	3,87	M17×1
04	1,06	0,99	1,99	1,96	2,74	2,54	5,13	5,04	M20×1
05	1,25	1,24	2,32	2,45	3,91	3,87	7,25	7,65	M25×1,5
06	1,48	1,55	2,73	3,07	5,44	5,69	10,0	11,3	M30×1,5
07	1,75	1,91	3,22	3,83	7,39	8,10	13,6	16,2	M35×1,5
08	2,05	2,34	3,79	4,74	9,82	11,2	18,2	22,7	M40×1,5
09	2,39	2,82	4,45	5,79	12,8	15,1	23,8	31,0	M45×1,5
10	2,78	3,36	5,19	7,00	16,4	19,8	30,6	41,3	M50×1,5
11	3,20	3,96	6,02	8,36	20,6	25,6	38,9	54,0	M55×2
12	3,65	4,62	6,94	9,88	25,6	32,4	48,6	69,3	M60×2
13	4,15	5,34	7,94	11,6	31,4	40,4	60,1	87,5	M65×2
14	4,68	6,12	9,04	13,4	38,0	49,7	73,4	109	M70×2
15	5,25	6,95	10,2	15,4	45,6	60,3	88,7	134	M75×2
16	5,86	7,85	11,5	17,6	54,1	72,4	106	163	M80×2
17	6,51	8,81	12,9	20,0	63,7	86,2	126	195	M85×2
18	7,19	9,82	14,3	22,5	74,3	102	148	233	M90×2
19	7,91	10,9	15,9	25,2	86,1	119	173	275	M95×2
20	8,66	12,0	17,5	28,1	99,2	138	201	322	M100×2
21	9,46	13,2	19,3	31,2	114	159	231	374	M105×2
22	10,3	14,5	21,1	34,4	129	182	265	433	M110×2
24	12,1	17,2	25,0	41,5	165	235	342	567	M120×2
26	14,0	20,1	29,4	49,3	206	297	434	729	M130×2
28	16,0	23,3	34,1	57,9	255	370	541	920	M140×2
30	18,2	26,7	39,1	67,3	310	454	666	1 144	M150×2
32	20,6	30,4	44,6	77,4	373	550	808	1 402	M160×3
34	23,1	34,3	50,5	88,4	444	659	971	1 699	M170×3
36	25,7	38,4	56,8	100,2	523	781	1 154	2 036	M180×3
38	28,5	42,8	63,4	112,7	611	918	1 360	2 417	M190×3
40	31,4	47,4	70,5	126,2	708	1 070	1 589	2 845	M200×3
44	37,7	57,5	85,8	155,5	933	1 423	2 125	3 853	Tr220×4
48	44,5	68,4	103		1 201	1 847	2 773		Tr240×4
52		80,4				2 349			Tr260×4
56		93,4				2 935			Tr280×4
60		107				3 612			Tr300×4
64		122				4 387			Tr320×5
68		138				5 266			Tr340×5
72		155				6 255			Tr360×5
84		212				9 957			Tr420×5
92		255				13 103			Tr460×5
500		302				16 855			Tr500×5

Mounting guidelines

Handling of Super Precision Bearings

Bore	Bore Reference Number	Axial clamping force		Tightening torque		Thread
		from kN	including	from Nm	including	
25	5	1,2	2,5	3,8	7,8	M25×1,5
30	6	1,4	2,8	5,2	10,3	M30×1,5
35	7	1,7	3,1	7,2	13,1	M35×1,5
40	8	2,4	3,8	11,3	18,2	M40×1,5
45	9	2,3	3,7	12,3	19,8	M45×1,5
50	10	2,6	4,0	15,3	23,6	M50×1,5
55	11	3,0	4,3	19,4	27,8	M55×2
60	12	3,3	4,7	23,1	32,9	M60×2
65	13	3,7	5,1	28,0	38,6	M65×2
70	14	4,1	5,4	33,3	43,8	M70×2
75	15	4,4	5,8	38,2	50,3	M75×2
80	16	4,8	6,2	44,3	57,2	M80×2
85	17	5,3	6,6	51,9	64,6	M85×2
90	18	5,7	7,1	58,9	73,4	M90×2
95	19	6,1	7,5	66,5	81,7	M95×2
100	20	6,5	7,9	74,4	90,5	M100×2
105	21	7,0	8,4	84,0	101	M105×2
110	22	7,4	8,8	92,9	111	M110×2
120	24	8,4	9,8	115	134	M120×2
130	26	9,3	10,8	137	160	M130×2
140	28	10,3	11,8	164	188	M140×2
150	30	11,3	12,8	192	218	M150×2
160	32	12,4	13,8	225	250	M160×3
170	34	13,4	14,9	258	286	M170×3
180	36	14,5	16,0	295	325	M180×3
190	38	15,7	17,2	337	369	M190×3
200	40	16,8	18,3	379	413	M200×3
220	44	19,2	20,7	476	513	Tr220×4
240	48	21,6	23,3	583	629	Tr240×4
260	52	24,2	25,8	707	754	Tr260×4
280	56	26,8	28,4	842	893	Tr280×4
300	60	29,5	31,1	993	1 047	Tr300×4
320	64	32,2	33,9	1 155	1 216	Tr320×5
340	68	35,0	36,8	1 333	1 402	Tr340×5
360	72	37,9	39,7	1 528	1 600	Tr360×5
380	76	40,9	42,7	1 739	1 816	Tr380×5
400	80	32,9	45,8	1 472	2 050	Tr400×5

5: Recommended clamping forces and nut tightening torque for Double Direction Angular Contact Thrust Ball Bearings from series 2344 and 2347

Left

4: Recommended clamping forces and nut tightening torque for spindle bearings in the following designs B, HS, HC and XC for diameter series 718, 719, 70 and 72. Values indicated correspond to a side face pressure of 10 MPa.

Lock nut recommendations

Lock nuts are generally used to clamp spindle bearing sets to the shaft. Nuts with axial bores are preferred over groove nuts to tighten to the shaft, because air turbulence occurring at high speeds is minimized.

The nut installation side should be ground with the thread in one chucking. A maximum axial runout tolerance of 2 µm is recommended. The clamping insert should be ground together with the thread and face, so that during the clamping procedure, the runout is not impaired.

Spindle bearing protocol – Assembly

It is recommended that measuring values be recorded for quality assurance purposes, e.g.

- Seating diameter, interference
- Spacer difference dimensions
- Steady-state temperature
- Radial and axial runout.

The use of a checklist can be helpful for this. Subsequently, an example and template are printed and these are also available at www.fag.com.

6: Spindle specimen checklist (page 208)

7: Spindle template checklist (page 209)

Check List Spindle Assembly

Milling Spindle (Example)	
Bearing Seat Diameter	
Spindle $\varnothing 70 \pm 0,004$	front $d1 = + 0,002$ back $d2 = 0$
Housing $\varnothing 110 - 0,004 / + 0,006$	front $D1 = + 0,003$ back $D2 = +0,003$
Length Difference of spacers L: max. $\pm 0,002$ Measured: 0	
Gap S before tightening screws 0,01 bis 0,03 Measured 0,02	
Balance rotating parts OK	
Bearings front: FAG HC7014E.T.P4S.UL	
Bearings back: FAG HC7014E.T.P4S.UL	
Designation checked OK divergent _____	
Grease Amount per Bearing: 9,2 cm³ OK, divergent: _____	
Lock nut tightening torque, initial 3 times = 219 Nm OK, loosen, then	
Lock nut tightening torque, final: 73 Nm OK	
Grease run in done OK	
Endurance run done, speed 10.000/min , OK Temp 44°C	
Room Temperature 24°C	
Information: The difference should not exceed 30 K without cooling	
Radial Run Out R max. 0,002 Measured 0,001	
Axial Run Out A max. 0,002 Measured 0,001	
Machine Tool: Machining Centre Spindle: Drawing, Serial Number	
Place: _____ Date: _____ Technician: _____	

Check List Spindle Assembly

Milling Spindle (Example)		
Bearing Seat Diameter		
Spindle Ø	front d1 =	back d2 =
Housing Ø	front D1=	back D2 =
Length Difference of spacers L: <i>max.</i>		Measured:
Gap S before tightening screws		Measured:
Balance rotating parts		
Bearings front:		
Bearings back:		
Designation checked	divergent _____	
Grease Amount per Bearing: _____, divergent: _____		
Lock nut tightening torque, initial 3 times =		
loosen, then		
Lock nut tightening torque, final:		
Grease run in done		
Endurance run done, speed _____, Temp _____		
Room Temperature		
Information:		
Radial Run Out	R max.	Measured
Axial Run Out	A max.	Measured
Machine Tool:		Spindle:
Place: _____	Date: _____	Technician: _____

This form is available for download under www.fag.com.

Mounting guidelines

Clearance Adjustment in Cylindrical Roller Bearings

Clearance adjustment in Cylindrical Roller Bearings

Cylindrical roller bearings with tapered bore are mounted with clearance, zero-clearance or preload (see Table 8). This can be done to the precision of $\pm 1 \mu\text{m}$ with the help of an FAG enveloping circle measuring device.

In the following, as an example, the assembly procedure is described for cylindrical roller bearings with tapered bores and removable outer rings (N10 and NN30) and enveloping circle gauge FAG MGA 31. The gauge is used to precisely set the radial internal clearance or preload of cylindrical roller bearings.

- The raceway diameter of the mounted outer ring is measured using a conventional internal gauge (Figure 9).
- This dimension is transferred to two hardened and precision ground measuring surfaces of the enveloping circle gauge (Figure 10).
- Next, the measuring device is positioned over the inner ring/roller assembly on the tapered shaft (Figure 11).
- The bearing is moved axially on the shaft until the precision indicator on the enveloping circle gauge shows the required radial internal clearance or preload. Subsequently, the distance from the bearing inner ring to the shaft shoulder is determined with gauge blocks that are adjusted 90 degrees on four measurement points (Figure 12).
- After the bearing inner rings have been disassembled, the gauge ring is ground to the width of the

corresponding determined distance and slid over the cylindrical section of the shaft.

- Finally, the bearing inner ring is remounted and secured with a nut.

If such a measuring device is not available, a fairly exact clearance adjustment can be achieved by measuring the axial drive-up distance of the inner ring onto the tapered shaft seating, **taper 1:12**.

Mounting Clearance/Preload	Attainable Speeds
Single row cylindrical roller bearings	
- 5 ... 0 [μm]	$< 0,75 \cdot n^*$ grease
0 [μm] (zero clearance)	$0,75 \dots 1,0 \cdot n^*$ grease
0 ... 5 [μm]	$1 \dots 1,1 \cdot n^*$ grease
0 ... 5 [μm]	$1,0 \cdot n^*$ oil

Double row cylindrical roller bearings	
- 5 ... 0 [μm]	$< 0,50 \cdot n^*$ grease
$2 \cdot 10^{-5} \cdot d_m$ [mm]	$0,50 \dots 0,75 \cdot n^*$ grease
$4 \cdot 10^{-5} \cdot d_m$ [mm]	$0,75 \dots 1,0 \cdot n^*$ grease
$1 \cdot 10^{-4} \cdot d_m$ [mm]	$1,0 \cdot n^*$ oil

* Speeds see bearing tables

$$d_m = (d + D)/2$$

These values are guide values for a ΔT up to 5 K between inner and outer ring. It is recommended to consult the Schaeffler Group's engineering department when using in applications with higher temperature differences (motor spindles).

8: Speed n for cylindrical roller bearings



9: Determination of outer ring raceway diameter



10: Transfer of the raceway diameter to the enveloping circle gauge

Mounting guidelines

Clearance adjustment in Cylindrical Roller Bearings

The drive-up distance is approx. **13 to 19 times (Factor F)** larger than the radial expansion in this way. Surface finish smoothing, inner ring elastic expansion and shaft contraction are the contributing factors. Table 13 serves to determine Factor F.

Drive-up distances $A = F \cdot \Delta G$

- d_B = Hollow shaft bores
- d' = Tapered seat diameter, measured in the centre of the taper
- d_B/d' = "Hollow shaft ratio"
- ΔG = Radial clearance change

d_B/d'	F
0...0,2	13
0,2...0,3	14
0,3...0,4	15
0,4...0,5	16
0,5...0,6	17
0,6...0,8	18
0,8...0,9	19

13: Hollow shaft properties and sliding factor

Example: The cylindrical roller bearing should be zero clearance after mounting.

First, insert the outer ring into the housing bore. Then, mount the inner ring with the spindle in the housing, slowly turning back and forth in order to prevent the spindle creating score marks. Slide the inner ring on the taper until there is a radial clearance of 20 μm , and with this the spindle is slowly rotated back and forth again. Measurement is made by radial shifting of the inner ring to the outer ring, e.g. by lifting the spindle, in doing so the dial gauge should be positioned close to the bearing.

Drive-up distance $A =$
Factor F · Radial clearance change ΔG ,

example $d_B/d' = 0,55$,
Radial clearance change $\Delta G = 20 \mu\text{m}$
Drive-up distance $A =$
 $17 \cdot 20 \mu\text{m} = 340 \mu\text{m} = 0,34 \text{ mm}$

Measure the axial distance between the inner ring and abutting shoulder, for example with gauge blocks that are adjusted 90 degrees on four measurement points. Grind the spacer ring to the measured value insert the ring into position. Finally mount the bearing and check for zero clearance.

When mounting cylindrical roller bearings, score marks can be safely avoided if the inner ring is not tilted to the outer ring and the spindle is rotated slowly back and forth during sliding. Heating the housing and the outer ring simplifies the mounting process as well. According to mounting procedure descriptions, it can be guaranteed that the bearing exhibits the required radial clearance after mounting and the bearing inner ring position on the shaft does not change due to vibration during operation.



11: Position of enveloping circle gauge



12: Determination of the distance to the shaft shoulder

Mounting guidelines

F'IS mounting service

F'IS mounting service

FAG Industrial Services (F'IS) offers high quality products, services and training for all types of bearing arrangements. Summary of F'IS mounting service:

- mounting and dismounting of rolling bearings of all types
- approval inspection of adjacent parts (shafts and housings)
- maintenance and inspection of bearing arrangements
- defect analysis on bearing arrangements not running satisfactorily
- advice on rationalization of mounting operations
- design and manufacture of special tools.

Using FAG Industrial Services provides many advantages:

- extended bearing life
- considerable cost reductions
- reduction of unplanned down time
- increased plant availability.

F'IS offers a large line of tools and measuring devices for spindle bearing mounting.

Devices for mounting super precision bearings

Measuring and heating devices for mounting spindle bearings can be acquired from F'IS. Sometimes, equipment can be rented.

Enveloping circle gauges

FAG enveloping circle gauge MGI 21

Enveloping circle gauges are used for setting the radial internal clearance of cylindrical roller bearings NNU4920-K to NNU4964-K and NNU4920 to NNU4964. Bearings with a bore diameter of 100 to 320 mm have removable inner rings. In the FAG enveloping circle gauge MGI 21, the inner enveloping circle of the roller and cage assembly is measured by two hardened and precision ground surfaces, one of which is movable. After mounting of the outer ring, the gauge is set to the inner enveloping circle of the roller and cage assembly. This dimension is measured using a snap gauge, for

example the SNAP.GAUGE...-.... It is then possible to set the inner ring to the diameter that gives the required radial internal clearance. Bearings with a tapered bore are slid onto the tapered seat of the shaft. For bearings with a cylindrical bore, preground inner rings are used (suffix F12) and finish ground to the required raceway diameter.

Ordering example for NNU4920:
MGI21.4920



14: FAG enveloping circle gauge MGI 21 for setting the radial internal clearance or preload of cylindrical roller bearings with removable inner ring

Mounting guidelines

F'IS mounting service

FAG enveloping circle gauge MGI 31

The FAG MGA 31 is available for setting the radial internal clearance of cylindrical roller bearings NN3006-K to NN3038-K and N1006-K to N1048-K. Bearings with a tapered bore have removable outer rings. The gauge is used to precisely set the radial internal clearance or preload of cylindrical roller bearings. The raceway diameter of the mounted outer ring is measured using a conventional internal gauge. This dimension is transferred to the two hardened and precision ground measuring surfaces of the enveloping circle gauge. The tapered shaft with the premounted inner ring and roller and cage assembly can then be inserted in the gauge. The shaft is moved axially by the

hydraulic method until the precision indicator of the enveloping circle gauge shows the required radial internal clearance or preload.

Ordering example for NN3006-K:
MGA31.3006

Snap gauges

FAG snap gauge SNAP.GAUGE...-...

This device serves to check the diameter of cylindrical shafts and all types of workpieces directly on the tool machine and to adjust the enveloping circle gauge MGI 21. The actual dimension of the workpiece can be determined precisely. The snap gauge functions as a comparator gauge. Its settings

Ordering designation	Range mm
SNAP.GAUGE30-60	30-60
SNAP.GAUGE60-100	60-100
SNAP.GAUGE100-150	100-150

17: Ordering designation SNAP GAUGE

are checked with shims that can be ordered for all diameters from F'IS as well.

Example for shaft diameter 120 mm:

SNAP.GAUGE100-150

(snap gauge)

SNAP.GAUGE.MASTER.DISK120

(shim)

Taper gauges

FAG taper gauge MGK 132

It is recommended to use the FAG taper measuring device to measure outer tapers with 0° to 6° taper angles and 90 to 510 mm taper diameters. The reproducibility of the measurement results is less than 1 µm with this device. The MGK132 rests on the work piece with four hardened, ground and lapped ledges. The ledges form an angle of 90°. A stop on the front or rear precisely defines the position of the gauge. Between the support ledges, the measurement slide runs on preloaded roller bearings. A dial gauge fixed in the housing acts against the measurement slide and indicates the deviation of the taper diameter from the nominal value. A precision indicator is fixed to the measurement slide. Its blade-shaped tip is in contact with the workpiece and measures the



15: FAG enveloping circle gauge MGA 31 for setting radial internal clearance of cylindrical roller bearings with removable inner ring



16: FAG snap gauge SNAP.GAUGE

Mounting guidelines

F'IS mounting service

deviation of the taper from the nominal value. The gauge is set using a gauge taper (available upon request).

FAG taper gauge MGK 133

for external tapers 1:12 and 1:30 and 27 to 205 mm taper diameter. The taper gauge MGK 133 rests on the taper with four hardened and polished support pins. The position of the gauge on the taper is defined by these pins and one stop. The stop can be attached to either the front or back of the gauge. The gauge contains two movable measuring brackets, one of which is in contact with the smaller taper diameter while the other, at a fixed distance, is in contact with the larger taper diameter. The deviation of the taper diameter from the nominal value is displayed in both measurement planes by a precision indicator. The reproducibility of the measurement results is less than 1 µm. The gauge is set using a gauge taper (available upon request).

Inductive heating devices

Many rolling bearings and other rotationally symmetrical parts made from steel have tight fits on the shaft. This is particularly applicable for high speed spindle bearings, since very high interferences have already been selected here, in order to prevent the inner ring from releasing under centrifugal force. Rapid and clean inductive heating is superior to conventional methods. It is therefore particularly suitable for batch mounting. Inductive heating devices HEATER10 to 150, which are supplied by FAG Industrial Service (F'IS), are suited for use with tool pieces up to 150 kg and are mobile and/or stationary. Detailed information, as well as larger designs, can be found in brochure TPI WL 80-54.

Equipment rental

Customers who require special mounting and measuring equipment only infrequently, for example in order to carry out repairs, can rent these from Schaeffler KG on a weekly basis. For a rather rare spindle bearing mounting, taper and enveloping circle measuring devices as well as heating devices can be rented and this is an economical alternative to having to purchase the required devices.





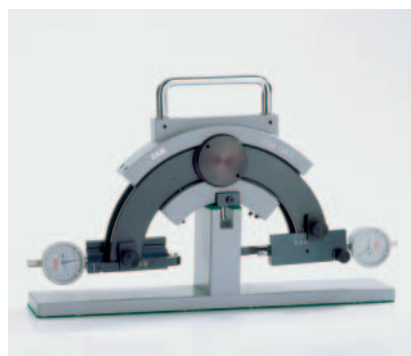

18: FAG taper gauge MGK 132

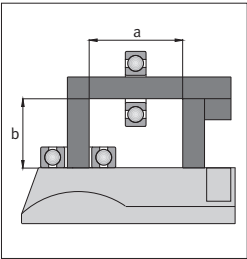

19: FAG taper gauge MGK 133

Mounting guidelines

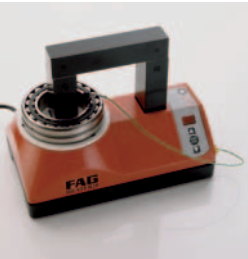
F'IS mounting service

Heating device	HEATER10	HEATER20	HEATER35	HEATER150
				
Power consumption max.¹⁾	2,3 kVA	3,6 kVA	3,6 kVA	12,8 kVA
Voltage/frequency²⁾	230 V/50 Hz	230 V/50 Hz	230 V/50 Hz	400 V/50 Hz
Current	10 A	16 A	16 A	32 A
Mass	7 kg	17 kg	31 kg	51 kg
Length	230 mm	345 mm	420 mm	505 mm
Width	200 mm	200 mm	260 mm	260 mm
Height	240 mm	240 mm	365 mm	440 mm
Dimension a	65 mm	120 mm	180 mm	210 mm
Dimension b	95 mm	100 mm	160 mm	210 mm
Ledges (incl.) for workpieces with min. bore.	20/45/65 mm (graduated supports)	20 mm 35 mm 60 mm	70 mm	100 mm
Ledges (accessories) for workpieces with min. bore.	10 mm 15 mm	10 mm 15 mm	15 mm 20 mm 35 mm 45 mm 60 mm	20 mm 30 mm 45 mm 60 mm 70 mm 85 mm

¹⁾ If lower voltage is used, the power will be reduced.

²⁾ Upon request, we can also supply heating devices with other rated voltages and frequencies as well as higher power ratings.

Mounting guidelines

F'IS Mounting Service

Maintenance & servicing training for tool machines – main spindles

The use of full performance capacity of FAG super precision bearings, expense reduction thanks to modern bearing arrangement concepts and the assembly and monitoring of FAG super precision bearings, make up the content of a one-day mounting training. The F'IS is regularly carried out especially for master craftsmen and Technicians from tool machining companies and manufacturers. During the training, new spindle designs as well as options to improve existing spindles are covered. Conclusion: Spindles work longer, more precise, faster – and enable the entire tool machine system to be noticeably more productive.

Spindle bearing training is split up into a theoretical and a practical parts:

Theoretical basics

- Bearing types, designs and performance features of FAG super precision bearings
- Tolerances for mating parts and their effects on bearing performance
- Lubrication of rolling bearings and rolling bearing damage
- Bearing monitoring during operation
- Damage analysis of FAG super precision bearings

Practical handling

- Mounting of spindle bearings
 - Mounting of cylindrical roller bearings with a tapered shaft seat
 - Use of inductive heating devices
 - Use of special measuring devices, e.g.:
 - boundary circle measuring devices
 - taper measuring instruments
- On-site training is available upon request.

Additional products and services

The F'IS catalog WL 80 250/3 EA has a full overview of the FAG Industrial Services line of products. You will receive the catalog and additional information on all services described here at

Schaeffler KG

FAG Industrial Services (F'IS)
Phone +49 9721 91-3142 or -2573
Fax +49 9721 91-3809

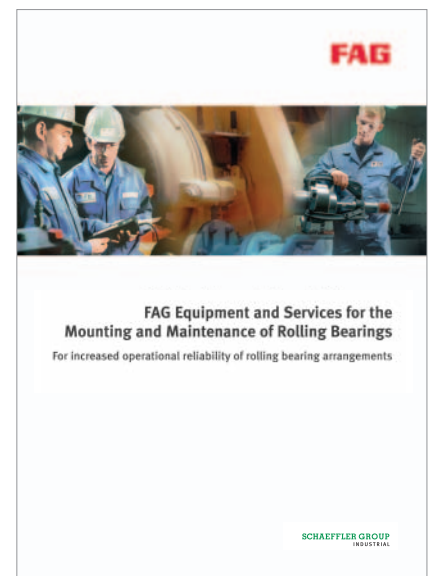

Customized Solutions

Spring preloaded non-locating bearing units ..SPP

Customized Solutions

The catalog table section covers spindle bearing solutions of standard envelope dimensions.

In the area of customized special solutions, optimal application solutions are shown with ordering nomenclature that make adapting spindle bearing products to the spindle installation situation as simple as possible. Products remain standard sizes and can be used in new designs as well as in existing spindle designs without any problems. According to the type designation system, the basic bearing type remains in the ordering designation. This allows for special solutions that were thought of during the series conception, these being speed, flexibility and uninterrupted service.

In addition, any individual bearing designs are available as special solutions (serial number) upon request.

Spring preloaded non-locating bearing units ..SPP

Spring Preloaded non-locating bearing units (SPP) are standard spindle bearings with a double-width outer ring. All tolerances of this bearing correspond to P4S. In addition, locating bores for spiral springs and an anti-rotation locking device are provided on the outer ring, whereby a ready-to-mount

spring preloaded unit is provided. Spring preloading force can be individually set with adjustment of the springs and by changing the number of springs supplied. The outer ring has thin layer chromium plating, as standard, and therefore ensures a secure sliding function of the bearing. The sliding function of the spring preloaded non-locating bearing unit is furthermore supported by the increased bearing width.



1: Spring preloaded non-locating bearing unit (-SPP-)

Customized Solutions

Spring preloaded non-locating bearing units ..SPP

All spindle bearing designs (contact angle, hybrid, Cronidur, steel, DLR, sealed...) are available with the designation SPP.

Ordering example:

HCB7014-E-SPP-2RSD-T-P4S



3: Sealed spring preloaded non-locating bearing unit (..SPP-2RSD-..)



2: Spring preloaded non-locating bearing units (-SPP-)

Customized Solutions

Spindle bearings, Thermally Robust Tandem Sets

Spindle bearings Thermally Robust Tandem Sets

Tandem sets in motor spindles are normally loaded differently during spindle operation. Temperature differences between both bearings, as well as between outer and inner rings, result in different distributions of axial and radial forces on individual bearings during operation. These different bearing loads influence both the rigidity and the tandem set service life.

Respective applications of matched tandem sets for motor spindles can greatly reduce this set of problems. With Thermally Robust Tandem Sets (according to ordering designation N18), specific universal bearings are so matched that this universal pair evenly carries application specific temperature differences between outer board and motor facing, inboard bearings, **during operation**. Thermally robust tandem sets N18 stand for

- constant rigidity
- longer operating life
- secure operation.



4: Spindle bearing tandem set

Ordering designation:

HCB7014-E-T-P4S-N18-DTL

These tandem sets can be designed to target one specific application, in which extreme temperature differences occur (N17).

Customized Solutions

Thin layer chromium coating on outer diameter (J24)

Thin layer chromium coating on outer diameter (J24)

In order to prevent fretting corrosion on the outer ring, spindle bearings, with the order designation J24, have an outer ring that is coated with a thin layer chromium coating. Thanks to this thin layer chromium coating, the coefficient of friction between the housing and outer ring constantly remains low. Since the thin chromium coating is taken into account during the manufacturing of the outer ring, then all tolerances are kept according to P4S. The outer diameter calibration remains. The coated bearings can be inserted into the existing spindle without any changes.

Ordering example:
HCB7014-E-T-P4S-J24J-UL



5: Spindle bearing with thin layer chromium coating on outer diameter (-J24J-)

Customized Solutions

Open spindle bearings supplied pre-greased

Open spindle bearings supplied pre-greased

Open spindle bearings, supplied pre-greased with the optimum amount of grease, can be selected with the order designation -L075, -L210 or -L055. The advantage of this variation is that on-site greasing is no longer necessary; the right grease, in the right amount, in the right place on the bearing is available and you do not lose any time during mounting. If no parts in close proximity to the bearing hold grease, then the use of sealed bearings is recommended (see bearing tables). In addition, Schaeffler Group Industrial's application engineering department should be consulted on a case by case basis.

Ordering example:

HCB7014-E-T-P4S-UL-L075

HCB7014-E-T-P4S-UL-L210

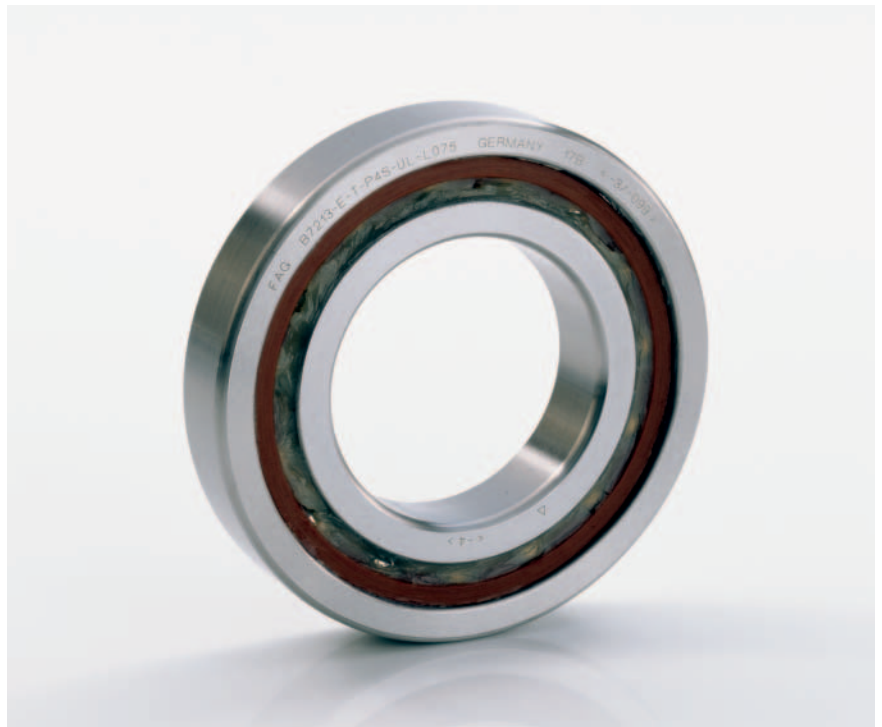

6: Open spindle bearings, supplied pre-greased with FAG ARCANOL L075

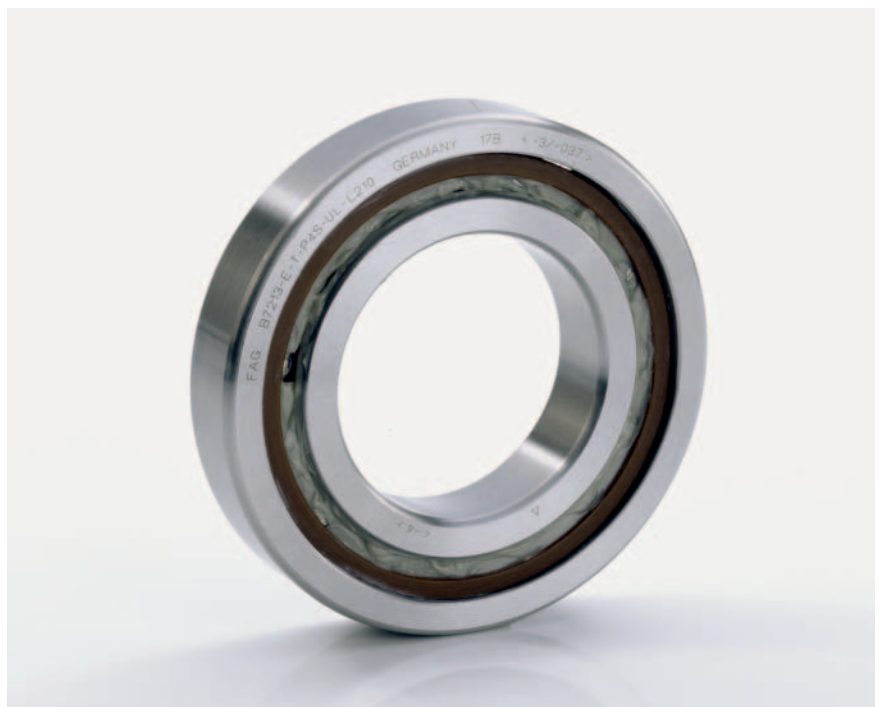

7: Open spindle bearings, supplied pre-greased with FAG ARCANOL L210

Customized Solutions

Floating Displacement bearing (FD.. -T64)

Floating Displacement bearing (FD.. -T64) with matched radial clearance

Radial bearing clearance can be matched to the current bore diameter on FD bearings with cylindrical bores upon request. At a specified shaft diameter tolerance this measure ensures that the radial clearance or preload of the FD bearing after the mounting process remains constant. The advantage of this match is that the bearings can be immediately mounted without presorting and these bearings can be easily switched during a spindle overhaul. Two such FD bearings can be arranged next to each other in application.

Ordering example:
FD1012-T-P4S-T64



8: Floating Displacement bearing in Direct-Lube design

Customized Solutions

Cylindrical Roller Bearings with cylindrical bore/special radial clearance

Cylindrical Roller Bearings

Cylindrical bore/special radial clearance

Apart from the standard series of single row cylindrical roller bearings (see page 102 ff.)

- N10.. K-M1-SP
- N10..K-PVPA-SP
- N10..K-HS-PVPA-SP
- HCN10..K-PVPA-SP
- N19..K-M1-SP

this series is also available with cylindrical bores upon request (without K). The engineering department should be consulted about the correct radial clearance design when using this bearing with cylindrical bores at high speeds. Radial clearance tables for cylindrical roller bearings with cylindrical bores include standardized values. Because an interference of the inner rings to the shaft is required for high speed operation, it is possible that cylindrical roller bearings run preloaded after being mounted in such a way. In this case, the radial clearance of the cylindrical roller bearing has to be redesigned with the help of the application engineering department.

Order designation for cylindrical roller bearings with special radial clearance:

HCN1014-PVPA-SP-R15-30NA



9: Super Precision Cylindrical Roller Bearings

Customized Solutions

Cylindrical Roller Bearings with reduced roller quantity

Cylindrical Roller Bearings

Reduced roller quantity

In order to optimise speed, rigidity and grease service life, the number of rollers pertaining to each application can be reduced on the single row cylindrical roller bearing series with PVPA cages. A reduction of the number of rollers means reduced rigidity and load ratings as well, however, temperature and friction is reduced on preloaded bearings. An increase in speed is possible through the reduced friction by having longer intervals between two overrolling motions. In addition, lubricant stress can be reduced, this leads to an increase in grease service life for greased bearings. Application engineering consultation and calculation is necessary for this special cylindrical roller bearing design.

With N.. and HCN bearings with PVPA cage, half complement of rolling elements with the order designation "H193" are already standard.



10: Hybrid Cylindrical Roller Bearing with partial roller quantity

Ordering designation:

HCN1014-K-PVPA-H193-SP

Design of main spindles using BEARINX®

The calculation program for analysis and calculation of complete spindle bearing assemblies

Schaeffler KG offers customers the support they need for the reliable use of super precision bearings, even at the development stage. A key element in design consultations is the rolling bearing design. Schaeffler KG has successfully applied calculation programs in this area for over 30 years. Computer analysis of rolling bearing under realistically modelled operating conditions at the design stage of bearing arrangements gives time advantages in development and contributes to increased operational security.

BEARINX® – a leading calculation program

With BEARINX®, Schaeffler Group Industrial has created one of the leading programs for the calculation of rolling bearings. It allows detailed analysis of rolling bearing arrangements – from individual bearings to complex shaft systems, gearboxes and linear guidance systems. The complete calculation process takes place in a cohesive calculation model. Even in the case of extensive applications, the contact pressure of each individual rolling element is included in the calculation. The current version of BEARINX® includes a special module for spindle calculation. The functional scope of BEARINX® takes the influence of centrifugal force on load distribution and running behaviour of rolling elements in angular contact ball bearing, into account.

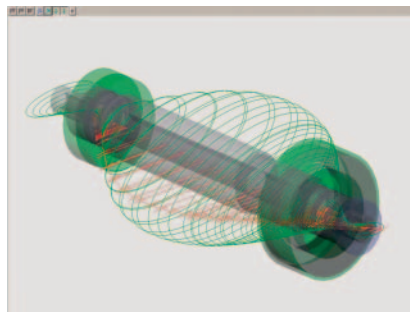

1: Deflection of the shaft

BEARINX® takes into account the following factors:

- the non-linear elastic deflection of bearings
- the elasticity of shafts and axes
- the influence of fits, temperature and speed on the operating clearance or preload of the bearings as well as contact angle
- roller and raceway profiles and osculation
- changes in contact angle due to loads in ball bearings and angular contact ball bearings
- the actual contact pressure taking into account skewing and profiling of the rolling elements
- the influence of lubrication conditions, contamination and actual contact pressure on the fatigue life of bearings

BEARINX® thus offers the possibility to determine the actual load on spindle bearings.

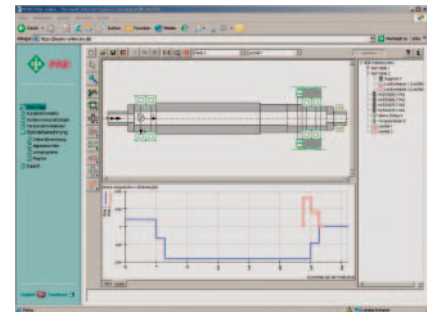

2: Calculation of the load distribution in a spindle

BEARINX® Spindle Calculation offers:

- recommendations on mounting fits as a function of the specified speed
- calculation of design parameters for contact pressure and kinematics in the bearing
- kinematic bearing frequencies for vibration analyses
- calculation of the rigidity of the bearing arrangement at the operating point taking into account all relevant influences
- shaft reactions such as shaft deflection and shaft inclination
- critical speeds and diagrammatic representation of the inherent forms
- calculation of fatigue life in accordance with ISO 281, Appendix 4
- further information is available upon request

3: Request for bearing calculation (right)

LH-Nr.:

Inquiry for Data for Bearing Calculation (Drawing included: yes / no)

<p>Bearing Arrangement (Sketch, e.g. << >):</p> <div style="border: 1px dashed black; height: 40px; width: 100%;"></div> <p>Rigid Preload <input type="checkbox"/> Spring Preload <input type="checkbox"/></p> <p>Spring Force: _____</p>	<p>Application: _____</p> <p>Drive: _____</p> <p>Shaft Position: vertical <input type="checkbox"/> horizontal <input type="checkbox"/> tilting <input type="checkbox"/></p>
--	---

Bearing Type(s) Working Side (Front) _____	Bearing Type(s) Drive Side (Rear) _____
---	--

Max. Speed [rpm]: _____	Lubrication: _____	Nom.-Viscosity: cSt _____
-------------------------	--------------------	---------------------------

Load Cycles:							
Fr [kN]	Fa [kN]	Ft [kN]	Speed n [rpm]	Time Share [%]	Tool Diameter [mm]	Cantil. arm a [mm]	Belt Force/ F _R [kN]

Specific Influences / Operating Conditions:	<u>Assumptions:</u> Bearing Temperature. Front/Back: T = / C, ΔT (IR/AR) f/b = / K, Interference (Shaft/IR) f/b: / μm
---	---

Bearing Distance l = _____ mm, Belt Distance b = _____ mm, a = _____



Questions: (Please enclose a drawing if possible!)

Name: _____ Date: _____
 This form is available for download under www.fag.com.

Check List Spindle Assembly

Milling Spindle (Example)	
Bearing Seat Diameter Spindle $\varnothing 70 \pm 0,004$ front $d1 = + 0,002$ back $d2 = 0$ Housing $\varnothing 110 - 0,004 / + 0,006$ front $D1 = + 0,003$ back $D2 = +0,003$ Length Difference of spacers L: max. $\pm 0,002$ Measured: 0 Gap S before tightening screws 0,01 bis 0,03 Measured 0,02	
Balance rotating parts OK	
Bearings front: FAG HC7014E.T.P4S.UL Bearings back: FAG HC7014E.T.P4S.UL Designation checked OK divergent _____	
Grease Amount per Bearing: 9,2 cm³ OK, divergent: _____	
Lock nut tightening torque, initial 3 times = 219 Nm OK, loosen, then Lock nut tightening torque, final: 73 Nm OK	
Grease run in done OK Endurance run done, speed 10.000/min , OK Temp 44°C Room Temperature 24°C Information: The difference should not exceed 30 K without cooling	
Radial Run Out R max. 0,002 Measured 0,001 Axial Run Out A max. 0,002 Measured 0,001	
Machine Tool: Machining Centre Spindle: Drawing, Serial Number Place: _____ Date: _____ Technician: _____	

Check List Spindle Assembly

Milling Spindle (Example)		
Bearing Seat Diameter		
Spindle Ø	front d1 =	back d2 =
Housing Ø	front D1=	back D2 =
Length Difference of spacers L: <i>max.</i>		Measured:
Gap S before tightening screws		Measured:
Balance rotating parts		
Bearings front:		
Bearings back:		
Designation checked	divergent _____	
Grease Amount per Bearing: _____, divergent: _____		
Lock nut tightening torque, initial 3 times = loosen, then		
Lock nut tightening torque, final:		
Grease run in done		
Endurance run done, speed _____, Temp _____		
Room Temperature		
Information:		
Radial Run Out	R max.	Measured
Axial Run Out	A max.	Measured
Machine Tool:		Spindle:
Place: _____	Date: _____	Technician: _____

This form is available for download under www.fag.com.

Recommendations for the grease distribution run of non sealed and sealed spindle bearings

The run-in procedure includes several cycles of a stop and go run with different speeds and running times in which the standstill times after each run are of great importance. The necessary number of cycles can differ depending on bearing size, bearing number, max. speed and bearing environment. Monitoring of the temperature development is always recommended.



Additional cycles with extended running time and shorter stops should be carried out until steady-state temperature is reached.

Recommended grease quantities [cm³]

Bore reference number	HS719 HC719 XC719	HS70 HC70 XC70	B719 HCB719 XCB719	B70 HCB70 XCB70 FD	B72 HCB72 XCB72	N10	N19	NN30	NNU49	2344 2347
6		0,12		0,04						
7		0,13		0,06						
8		0,17		0,11						
9		0,21		0,10						
00	0,17	0,26	0,09	0,17	0,26					
01	0,18	0,28	0,10	0,21	0,36					
02	0,28	0,46	0,17	0,32	0,48					
03	0,32	0,58	0,17	0,42	0,68					
04	0,58	0,98	0,36	0,76	1,12					
05	0,68	1,14	0,40	0,86	1,44					
06	0,92	1,72	0,42	1,12	2,10	0,69		0,76		3,90
07	1,18	2,20	0,64	1,74	3,00	0,91		0,95		5,00
08	1,62	2,60	1,36	2,35	3,80	1,15		1,14		6,10
09	2,10	3,65	1,60	3,00	4,55	1,44		1,61		7,80
10	2,35	4,00	1,74	3,30	5,45	1,56	0,81	1,74		8,35
11	3,40	5,95	2,20	4,60	6,50	2,25	1,05	2,55		12,20
12	3,60	6,40	2,50	4,95	8,00	2,45	1,13	2,70		12,20
13	3,90	6,80	2,65	5,30	9,35	2,60	1,20	2,85		13,30
14	5,80	9,20	4,35	7,10	10,80	3,10	2,05	4,20	2,90	17,80
15	6,10	9,70	4,60	7,50	12,90	3,30	2,20	4,45	3,10	18,90
16	7,00	12,80	4,90	9,65	12,30	4,30	2,30	6,10	3,25	25,60
17	8,55	13,40	6,80	10,30	18,30	4,50	3,15	6,40	4,50	27,80
18	9,40	17,70	7,10	13,30	19,10	5,75	3,30	7,85	4,75	38,90
19	9,85	18,40	7,45	13,90	26,10	6,00	3,45	8,20	4,95	38,90
20	12,80	19,20	9,70	14,60	27,20	6,20	4,05	8,50	6,25	44,40
21	13,30	24,60	10,10	15,00	36,30	7,75	4,25	10,60	6,50	61,10
22	14,70	28,20	10,40	21,90	43,90	8,50	4,45	13,70	6,75	61,10
24	17,90	30,30	14,20	23,60	38,80	9,05	5,85	15,90	10,10	66,70
26	24,00	43,70	18,10	36,10	41,90	14,90	7,65	21,20	13,60	105,60
28	25,60	46,30	19,30	38,30	58,60	15,70	8,05	24,10	12,10	116,70
30	37,80	57,10	28,40	44,70	81,30	19,00	12,00	29,30	21,20	138,90
32	39,90	69,70	30,00	58,20	102,90	23,00	12,60	37,20	22,40	172,20
34			31,70	65,30	120,40	30,80	13,30	48,80	23,60	227,80
36			47,40	94,90	125,70	38,30	19,10	63,50	32,70	316,70
38			50,00	99,10	155,40	55,80	20,00	67,40	34,20	311,10
40			70,60	118,30	187,80	67,90	29,70	86,70	54,50	411,10
44			68,30	172,60	250,10	72,50	32,10	110,10	59,00	522,20
48			73,70	185,30		112,50	34,50	127,50	63,60	622,20
52			118,20	267,00		119,10	52,60	177,30	109,50	833,30
56			126,00	283,90		157,70	55,90	196,70	116,60	850,00

The series HS, HC and XC are also available as sealed and greased versions HSS, HCS and XCS. Current types of the B-series are also available as sealed and greased versions, suffix 2RSD.

Other Products

The World of Super Precision Bearings



7: Barden Super Precision Ball Bearing catalog – Speciality Products

Other super precision products are included in the catalogue “Barden Super Precision Ball Bearings – Speciality Products”. It is available from:
The Barden Corporation (UK)
 Plymbridge Road, Estover,
 Plymouth PL6 7LH, Devon
 Phone: +44(0) 17 52-73 55 55
 Fax: +44(0) 17 52-73 34 81
 E-mail: sales@barden.co.uk

An overview of Schaeffler Group Industrial product line can be found in the “rolling bearing” catalog (HR1 and/or WL 41 700), Figure 8.



8: “Rolling bearings” catalog from Schaeffler Group Industrial (HR1)

At www.fag.de and www.ina.de, you will find FAG and INA products available in a user-friendly form for calculation, generation of drawings etc. You can also access additional services, such as the rolling bearing library, regional support and much more here.

The electronic medium medias® includes the entire program on rolling bearings, plain bearings and linear systems from Schaeffler KG and are also available on CD.

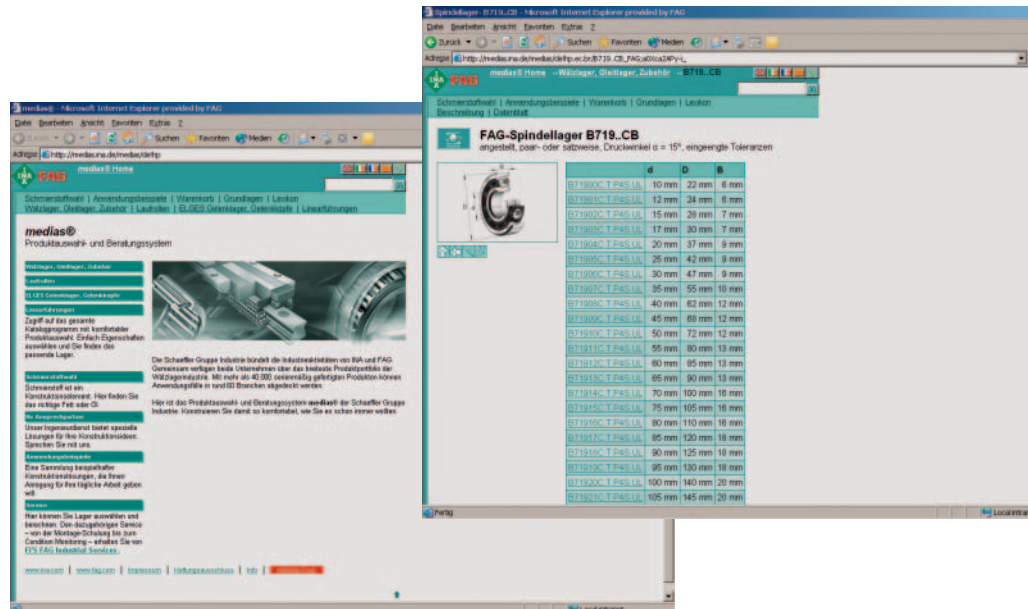

9: www.fag.com – Bearing data and calculation possibilities with medias®

6: left
 Overview map of recommended grease distribution run and grease amounts

Other Products

The World of Super Precision Bearings



10: Customer Newsletter “added competence” of Schaeffler Branchenmanagements Production Machinery

Schaeffler Group Industrial has a newsletter for their customers in five languages (German, English, French, Italian and Spanish) about the Production Machinery Branch, with current information, which is available at “FAGinfo@schaeffler.com” or a current version can be downloaded at www.fag.de and www.ina.de.



The Schaeffler KG offers other premium products for machine tools, upon which you can request further information for in your national language via the contact details (see Appendix).

11: Additional FAG and INA products for machine tools

Addresses

Germany

Schaeffler KG

Industriestrasse 1-3
91074 Herzogenaurach
Phone +(49) (0) 91 32 / 82 0
Fax +(49) (0) 91 32 / 82 49 50
E-Mail info@schaeffler.com

Schaeffler KG

Georg-Schäfer-Strasse 30
97421 Schweinfurt
Phone +(49) (0) (9721) 91-0
Fax +(49) (0) (9721) 91-3435
E-Mail FAGinfo@schaeffler.com

Austria

Schaeffler Austria GmbH

Ferdinand Pölzl-Strasse
22560 Berndorf-St. Veit
Phone +(43) (2672) / 202-0
Fax +(43) (2672) / 202-10 03
E-Mail info.at@schaeffler.com

Switzerland

HYDREL GmbH

Badstrasse 14
8590 Romanshorn
Phone +(41) (0) 71 / 4 66 66 66
Fax +(41) (0) 71 / 4 66 63 33
E-Mail info.ch@schaeffler.com

Engineering offices Germany

Engineering Office, Nuremberg

Industriestrasse 1-3
91074 Herzogenaurach
Phone +(49) (0) 91 32 / 82 23 47
Fax +(49) (0) 91 32 / 82 49 30
E-Mail IB.Nuernberg@schaeffler.com

Engineering office, Munich

Lackerbauerstrasse 28
81241 München
Phone +(49) (0) 89 / 89 60 74 0
Fax +(49) (0) 89 / 89 60 74 20
E-Mail IB.Muenchen@schaeffler.com

IB Stuttgart Süd (Lahr)

Dr. Georg-Schaeffler-Strasse 1
77933 Lahr
Phone +(49) (0) 78 21 / 58 42 39
Fax +(49) (0) 78 21 / 5 15 71
E-Mail IB.Lahr@schaeffler.com

IB Stuttgart Süd

Untere Waldplätze 32
70569 Stuttgart
Phone +(49) (0) 7 11 / 6 87 87 51
Fax +(49) (0) 7 11 / 6 87 87 10
E-Mail IB.Stuttgart@schaeffler.com

Regional office, Stuttgart north

Untere Waldplätze 32
70569 Stuttgart
Phone +(49) (0) 7 11 / 6 87 87 41
Fax +(49) (0) 7 11 / 6 87 87 10
E-Mail IB.Stuttgart@schaeffler.com

IB Offenbach Süd

Gutenbergstrasse 13
63110 Rodgau
Phone +(49) (0) 61 06 / 85 06 41
Fax +(49) (0) 61 06 / 85 06 49
E-Mail IB.Offenbach@schaeffler.com

IB Offenbach Nord

Gutenbergstraße 13
63110 Rodgau
Phone +(49) (0) 61 06 / 85 06 41
Fax +(49) (0) 61 06 / 85 06 49
E-Mail IB.Offenbach@schaeffler.com

IB Rhein-Ruhr-Süd

Mettmanner Strasse 79
42115 Wuppertal
Phone +(49) (0) 2 02 / 2 93 28 59
Fax +(49) (0) 91 32 / 82 45 96 03
E-Mail
IB.Rhein-Ruhr-Sued@schaeffler.com

IB Rhein-Ruhr-Nord

Mettmanner Strasse 79
42115 Wuppertal
Phone +(49) (0) 2 02 / 2 93 28 48
Fax +(49) (0) 91 32 / 82 45 96 02
E-Mail
IB.Rhein-Ruhr-Nord@schaeffler.com

Engineering Office, Bielefeld

Gottlieb-Daimler-Strasse 2-4
33803 Steinhagen
Phone +(49) (0) 52 04 / 99 95 00
Fax +(49) (0) 52 04 / 99 95 01
E-Mail IB.Bielefeld@schaeffler.com

Engineering office, Hannover

Hildesheimer Strasse 284
30519 Hannover
Phone +(49) (0) 5 11 / 98 46 99 0
Fax +(49) (0) 5 11 / 8 43 71 26
E-Mail IB.Hannover@schaeffler.com

Engineering office, Hamburg

Pascalkehe 13
25451 Quickborn
Phone +(49) (0) 41 06 / 7 30 83
Fax +(49) (0) 41 06 / 7 19 77
E-Mail IB.Hamburg@schaeffler.com

Engineering Office, Berlin

Cunostraße 64
14193 Berlin
Phone +(49) (0) 30 / 8 26 40 51
Fax +(49) (0) 30 / 8 26 64 60
E-Mail IB.Berlin@schaeffler.com

Engineering Office, Chemnitz

Oberfrohnauer Straße 62
09117 Chemnitz
Phone +(49) (0) 3 71 / 8 42 72 13
Fax +(49) (0) 3 71 / 8 42 72 15
E-Mail IB.Chemnitz@schaeffler.com

Addresses

Argentina

Schaeffler Argentina S.r.l.

Avda. Alvarez Jonte 1938
Ciudad de Buenos Aires
Phone +54 11 40 16 15 00
Fax +54 11 45 82 33 20
E-Mail info-ar@schaeffler.com

Australia

FAG Australia Pty Limited

FAL Level 1, Bldg 8, Forest Central
Business Park,
49 Frenchs Forest
Phone +61 29452 42 42
Fax +61 28977 1000
E-Mail info.au@schaeffler.com

Belgium

Schaeffler Belgium S.P.R.L.

Avenue du Commerce, 38
Braine L'Alleud 1420
Phone +32 2 3 89 13 89
Fax +32 2 3 89 13 99
E-Mail info.be@schaeffler.com

Bosnien-Herzegovina

Schaeffler Hrvatska d.o.o.

Ogrizovićeve 28b
Zagreb 10000
Croatia
Phone +385 1 37 01 943
Fax +385 1 37 64 473
E-Mail info.hr@schaeffler.com

Brazil

Schaeffler Brasil Ltda.

IBR, Schaeffler Brasil Ltda.
IBR
Av. Independência, 3500-A
Bairro Éden
18087-101 Sorocaba
Phone (55) 15 3335 1500
Fax +(55) 15 3335 1960
E-Mail info.br@schaeffler.com

Bulgaria

Schaeffler Bulgaria OOD

Boul. Knjaz Alexander Dondukov
No 62 Eing. A, 6. Etage, App. 10
Sofia 1504
Phone +359 2 946 39 00
Fax +359 2 943 41 34
E-Mail info.bg@schaeffler.com

Canada

Schaeffler Canada Inc.

2871 Plymouth Drive Oakville,
ON L6H 5S5
Phone +1 905 8 29 27 50
+1 800 263 - 43 97 (Toll Free)
Fax +1 905 8 29 25 63
E-Mail info.ca@schaeffler.com

Chile

Schaeffler Chile Ltda.

Hernando de Aguirre No. 268,
of. 201
Providencia, Santiago
Phone +56 2 477-5000
Fax +56 2 435-9079
E-Mail
sabine.heijboer@schaeffler.com

China

Beijing Representative Office

Room 708-711, Scitech Tower
22 Jianguomenwai Avenue
Beijing 100004
Phone +86 10 6515 0288
Fax +86 10 6512 3433
E-Mail l.huang@schaeffler.com

Croatia

Schaeffler Hrvatska d.o.o.

Ogrizovićeve 28b
Zagreb 10000
Phone +385 1 37 01 943
Fax +385 1 37 64 473
E-Mail info.hr@schaeffler.com

Czechia

Schaeffler CZ s r.o.

Prubezná 74a
100 00 Praha 10
Phone +420 267 298 111
Fax +420 267 298 110
E-Mail info.cz@schaeffler.com

Denmark

Schaeffler Danmark ApS

Jens Baggesens Vej 90P
Århus N 8200
Phone +45 70 15 44 44
Fax +45 70 15 22 02
E-mail info.dk@schaeffler.com

Addresses

Egypt

Delegation Office Schaeffler KG

Obour Buildings-Salah Salem
St.-No. 25 – Floor 18 – Flat 4
Nasr City Cairo 11811
Phone +20 24 01 24 32
+20 22 61 26 37
Fax +20 22 61 26 37
+20 24 01 24 32
E-Mail schaeffleregypt@link.net

Estonia

Schaeffler KG Baltic representation

K. Ulmana gatve 119
Riga 2167
Latvia
Phone +371 7 06 37 95
Fax +371 7 06 37 96
E-Mail info.lv@schaeffler.com

Finland

Schaeffler Finland Oy

Lautamiehentie 3
Espoo 02770
Phone +358 207 36 6204
Fax +358 207 36 6205
E-Mail info.fi@schaeffler.com

France

Schaeffler France SAS

93, route de Bitche, BP 30186
Haguenau 67506
Phone +33 3 88 63 40 40
Fax +33 3 88 63 40 41
E-Mail info.fr@schaeffler.com

Great Britain

Schaeffler (UK) Ltd.

Forge Lane, Minworth
Sutton Coldfield B76 1AP
Phone +44 121 3 51 38 33
Fax +44 121 3 51 76 86
E-Mail info.uk@schaeffler.com

The Barden Corporation (UK) Ltd.

Plymbridge Road – Estover
Plymouth PL6 7LH
Phone +44 1752 73 55 55
Fax +44 1752 73 34 81
E-Mail sales@barden.co.uk

Hungary

Schaeffler Magyarország Ipari Kft.

Neumann János út 1/B fsz.
Budapest 1117
Phone +36 1 4 81 30 50
Fax +36 1 4 81 30 53
E-Mail budapest@schaeffler.com

India

FAG Bearings India Ltd.

B-1504, Statesman House, 148,
Barakhamba Road
New Dehli 110 001
Phone +91 11 237382-77
Fax +91 11 51521478
E-Mail purim@fag.co.in

Italy

Schaeffler Italia S.r.l.

Strada Regionale 229 Km 17
Momo 28015
Phone +39 3 21 92 92 11
Fax +39 3 21 92 93 00
E-Mail info.it@schaeffler.com

Japan

Schaeffler Japan Co., Ltd.

Square Building, 18. Floor.
2-3-12 Shin-Yokohama, Kohoku-ku
Yokohama 222-0033
Phone +81 45 476 5900
Fax +81 45 476 5920
E-Mail info.jp@schaeffler.com

Korea

Schaeffler Korea Corporation

Samsung Fire-Marine Insurance Bld.,
11-12 F
#87, Euljiro-1ga, Jung-gu
Seoul 100-191
Phone +82 2 311 3000
Fax +82 2 311 3050
E-Mail
heonkyeong.lee@schaeffler.com

Mexico

INA Mexico, S.A. de C.V.

Paseo de la Reforma 383, int.704
Colonia Cuahtémoc
Mexico D.F. 06500
Phone +52 55 55 25 00 12
Fax +52 55 55 25 01 94
E-Mail info.mx@schaeffler.com

Addresses

Nederland

Schaeffler Nederland B.V.

Gildeweg 31
Barneveld 3771 NB
Phone +31 342 40 30 00
Fax +31 342 40 32 80
E-Mail info-nl@schaeffler.com

Norway

Schaeffler Norge AS

Nils Hansens vei 2
Oslo 0667
Phone +47 23 24 93 30
Fax +47 23 24 93 31
E-Mail info.no@schaeffler.com

Poland

Schaeffler Polska Sp. z o.o.

Ul. Szyszkowa 35/37
Warszawa 02-285
Phone +48 22 878 41 20
Fax +48 22 878 41 22
E-Mail info.pl@schaeffler.com

Portugal

INA Rolamentos Lda.

Av. Fontes Pereira de Melo, 470
Porto 4149-012
Phone +351 22 5 32 08 00
Fax +351 22 5 32 08 60
E-Mail info.pt@schaeffler.com

Romania

S.C. Schaeffler Romania S.R.L.

Aleea Schaeffler Nr. 3
Cristian/Brasov 507055
Phone +40 268 50 58 08
Fax +40 268 50 58 48
E-Mail info.ro@schaeffler.com

Russia

Schaeffler Russland GmbH

Leningradsky Prospekt 37A
Korp. 14
Moscow 125167
Phone +7 495 7 37 76 60
Fax +7 495 7 37 76 53
E-Mail info.ru@schaeffler.com

Singapore

Schaeffler (Singapore) Pte. Ltd.

151 Lorong Chuan,
#06-01 New Tech Park, Lobby A
Singapore 556741
Phone +65 6540 8600
Fax +65 6540 8668
E-Mail info.sg@schaeffler.com

Slovak Republic

Schaeffler Slovensko, spol.s.r.o.

Nevädzova 5
Bratislava 821 01
Phone +421 2 43 294 260
Fax +421 2 43 330 820
E-Mail fag@fag.sk

Slovenia

Schaeffler Slovenija d.o.o.

Glavni trg 17/b
Maribor 2000
Phone +386 2 22 82 070
Fax +386 2 22 82 075
E-Mail info.si@schaeffler.com

South-Africa

Schaeffler South Africa (Pty.) Ltd.

1 End Street Ext.
Corner Heidelberg Road
Johannesburg 2000
Phone +27 11 225 30 00
Fax +27 11 334 17 55
E-Mail info.co.za@schaeffler.com

Spain

Schaeffler Iberia, s.l.

Polígono Ind. Pont Reixat
Sant Just Desvern 08960
Phone +34 93 4 80 34 10
Fax +34 93 3 72 92 50
E-Mail info.es@schaeffler.com

Sweden

Schaeffler Sverige AB

INS, Charles gata 10
Arlandastad 195 61
Phone +46 8 59 51 09 00
Fax +46 8 59 51 09 60
E-Mail info.se@schaeffler.com

Addresses

Switzerland

HYDREL GmbH

Badstrasse 14
Romanshorn 8590
Phone +41 71 4 66 66 66
Fax +41 71 4 66 63 33
E-Mail info.ch@schaeffler.com

Taiwan

Schaeffler Taiwan Co Ltd

105 Rm H, 8FNo. 168,
Dun Hua N. Road
Taipei
Phone +886 2 2175 1928
Fax +886 2 2545 2828
E-Mail info.tw@schaeffler.com

Thailand

Schaeffler (Thailand) Co., Ltd.

388 Exchange Tower, 34th Floor
Sukhumvit Road, Klongtoey
Bangkok 10110
Phone +66 2 697 00 00
Fax +66 2 697 00 01
E-Mail info.th@schaeffler.com

Tunisia

FAG AFRIQUE DU NORD

66 Avenue de Carthage
Tunis 1000
Phone +216 1 34 14 48
Fax +216 1 33 67 04
E-Mail
michael.kuehn@schaeffler.com

Turkey

Schaeffler KG

FAG Delegation Turkey
Aydin Sok 4 Dagli Apt. D: 4
1. Levent
Istanbul 34340
Phone +90 212 280 77 98
Fax +90 212 280 94 45
E-Mail fag@fag.com.tr

Ukraine

Schaeffler KG

Representative Office Ukraine
Jilyanskayastr. 75, 5-er Stock
Bussines Center «Iceberg»
Kiew 01032
Phone +380 44 593 02 81
Fax +380 44 593 02 83
E-Mail info.ua@schaeffler.com

United Arab Emirates

FAG ISS GmbH – Dubai

Office No.1001, Five Towers
Al Maktoum Street
Dubai
Phone +971 4 – 2 24 73 24
9 71 – 5 06 44 10 73
Fax +971 4 – 2 24 73 25
E-Mail fagdubai@emirates.net.ae

USA

Schaeffler Group USA Inc.

IFM, 308 Springhill Farm Road
Fort Mill, SC 29715
Phone +1 803 548 8500
Fax +1 803 548 8599
E-Mail info.us@schaeffler.com

Schaeffler Group USA Inc.

FBC

200 Park Avenue
P.O. Box 1933
Danbury, CT 06813-1399
Phone +1 203 790 54 74
Fax +1 203 830 81 71
E-Mail
Diana.DiBartolomeo@schaeffler.com

Venezuela

Schaeffler Venezuela

Torre BOD, Piso 14, Oficina 14-1
Urbanización San José de Tarbes
Valencia
Phone +58 58 241 825 47 47
Fax +58 58 241 825 97 05
E-Mail christian.ommundsen@
schaeffler.com

Vietnam

Schaeffler Vietnam Co., Ltd.

SVC, 221 Khanh Hoi St., Dist.4
Ho Chi Minh City/Vietnam
Phone +84 8 943 28 60
Fax +84 8 943 28 61
E-Mail info.vn@schaeffler.com

Index

Accuracy: 9, 18, 97 ff, 128, 138, 184, 194
Application examples: 194 ff
Axial clamping force: 206 f
Base unit: (see spring preloaded units SPP)
Bearing arrangement calculation: 197, 202
Bearing arrangement examples: 194, 199 ff
Bearing arrangements: 11, 177, 190, 194, 196 ff
Bearing code: 164 ff
Bearing design: 11, 194 ff
Bearing designations: 16, 18, 90, 100, 128
Bearing labeling: 16 f, 19, 91, 101, 129
Bearing monitoring: 192 f, 216
Bearing sets: 17, 194
BEARINX[®]: 187, 226
Checklists: 207, 228 f
Clamping force: 207
Clearance adjustment: 210 f
Coated bearings: 221
Contact angle: 16, 126, 180, 184, 194 ff, 219, 226
Cronidur 30: 9, 14, 18, 89 f, 195, 197, 219
Cylindrical Roller Bearings, Radial Clearance: 158 f, 212 f, 224
Cylindrical roller bearings: 9, 89, 96 ff, 124 ff, 142 ff, 152 ff, 170
Deflection: 190 f
Direct Lube spindle bearings (DLR): 12 f, 15, 18, 89, 99, 183, 223
Distances between bearings: 197
Double Direction Angular Contact Thrust Ball Bearings: 8, 124 ff, 185, 191, 207
Enveloping circle gauges: 210 ff
FD bearing (cp. Floating Displacement Bearing): 8, 88 ff, 138, 150, 202
Grease distribution: 181, 205
Grease: 9, 12 f, 18, 127, 176 ff, 182, 186, 205, 222
Greasing: 12, 178, 205
Handling: 178, 204 ff
Heating devices: 205, 212, 214 ff
Hybrid cylindrical roller bearings: 98 ff, 225
Hybrid spindle bearings: 9, 13 f
Inductive heating devices: 205, 212, 214 ff
Injection pitch circle: see bearing tables (Etk)
Interference: 187 f
Life calculation: 8, 184, 186, 197, 226
Lock nut: 207
Lubrication: 9, 12 f, 18, 127, 176 ff
Marking (cp. Bearing labeling)
Matching Procedures: 205
Medias: 231
Mounting service: 212 ff
Mounting: 6 ff, 99, 178, 204 ff, 212, 214, 216
Non-locating bearings: 89, 97, 193, 218 f
Nut tightening torque: 207

Index

Oil-air lubrication: 89, 99, 182, 183, 194
Preload: 9, 18, 181, 187, 190, 194, 210
Radial clearance setting: 189, 210 ff
Rigidity: 8, 11, 97 ff, 126, 190 ff, 220, 225
Ring expansion: 187, 194, 205
Sealed bearings: 12, 18, 20 ff, 144 ff, 196
Sealing: 186, 194, 196
Snap gauges: 213
Speed: 7 ff, 13 ff, 89, 98 f, 164, 175 ff
Spindle bearing sets (see Bearing sets): 89, 138, 144 ff, 182
Spindle bearings: 7 ff, 178 ff, 184, 189, 191, 195 f, 204, 207, 216, 220 ff, 230
Spring preloaded units (SPP): 202, 218, 219
Tandem sets: 220
Taper gauges: 213 f, 216
Tolerances for Mating Parts: 164 ff, 216
Tolerances for super precision bearings: 138 ff
TX-Bearings: 15, 183
Type designation: (see Bearing Designation)
Universal bearings: 11, 198, 220
X-life ultra bearings: 9, 14, 180, 195

Notes





Schaeffler KG

Industriestrasse 1–3
91074 Herzogenaurach (Germany)
Internet www.ina.com
E-Mail Info@schaeffler.com

In Germany:

Phone 0180 5003872
Fax 0180 5003873

From Other Countries:

Phone +49 9132 82-0
Fax +49 9132 82-4950



Schaeffler KG

Georg-Schäfer-Strasse 30
97421 Schweinfurt (Germany)
Internet www.fag.com
E-Mail FAGinfo@schaeffler.com

In Germany:

Phone 0180 5003872
Fax 0180 5003873

From Other Countries:

Phone +49 9721 91-0
Fax +49 9721 91-3435

